

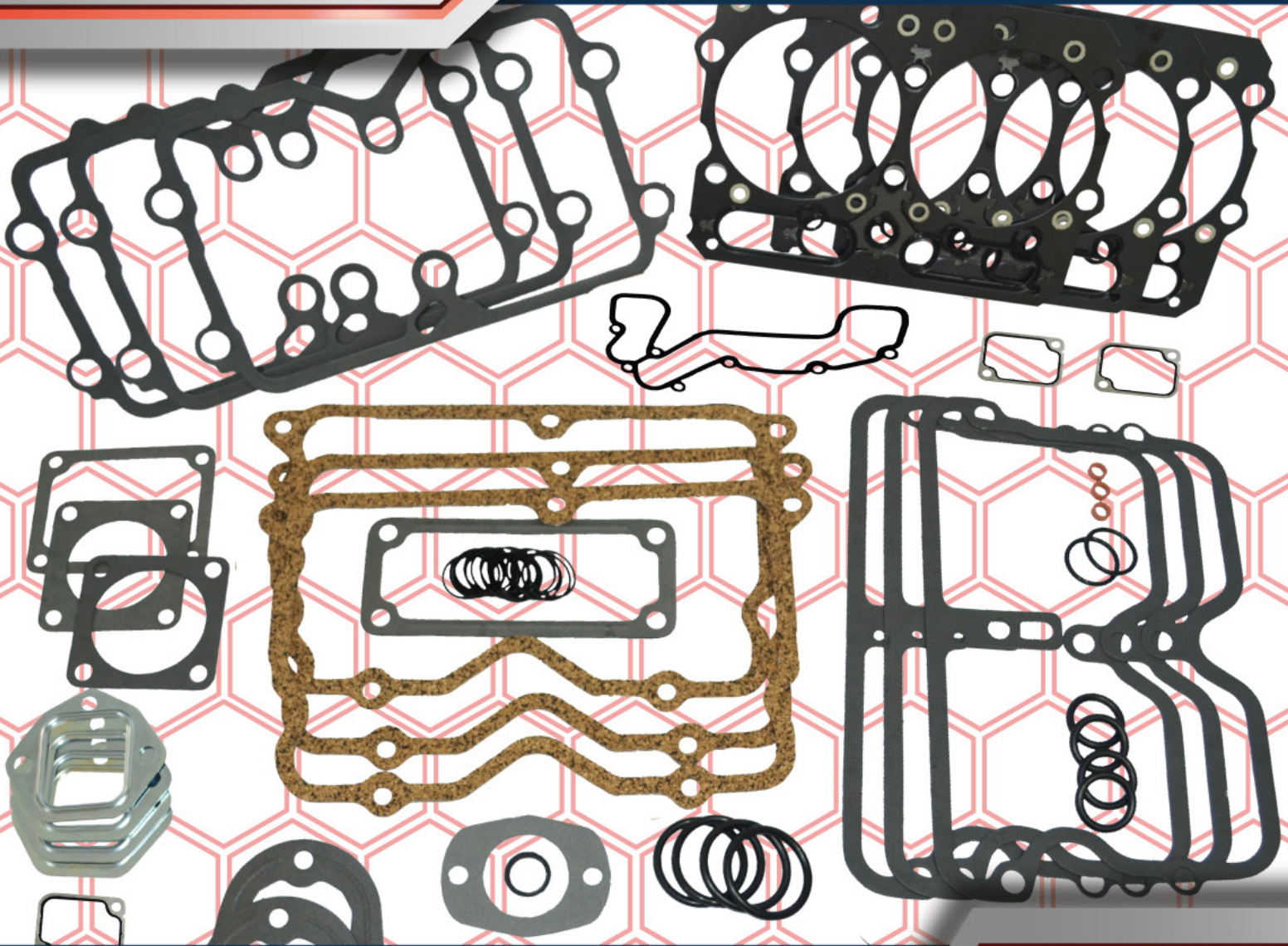

CATÁLOGO DIESEL



COMPRESORES

COMPRESORES

COMPRESORES 135

VD-001	TU-FLO 400
VD-002	TU-FLO 500
VD-009	TU-FLO 501
VD-012	Dina Cummins
VD-012-3	Dina Cummins
VD-012-4	Dina Cummins
VD-012-350	Cummins 350
VD-055	Midland tipo EL 740,2"
VD-056	Midland tipo EL 1300 / 1600,2"3/4
VD-057	Mercedes Benz
VD-058	Knorr 150 C.C.
VD-059	Bendix
VD-060	Knorr Combinado Mediano
VD-061	Wabco Grande
VD-062	Wabco Chico
VD-064	Bendix
VD-079	Compresor Electrónico N14
VD-080	Compresor Wabco Doble Pistón para Volvo
VD-081	Compresor York
VD-082	Cabeza Compresor Brasileña
VD-083	Compresor Wabco-Knorr
VD-084	Compresor Mult-60 Cabeza Volada (412352005)
VD-085	Compresor Wabco Doble Pistón para Mercedes Benz
VD-086	Compresor Cabeza Volada Volvo Wabco
VD-087	Compresor Bendix Doble Pistón
VD-088	Compresor Wabco Doble Pistón Mercedes Benz
VD-089	Compresor Wabco Doble Pistón Volvo
VD-090	Compresor Wabco Doble Pistón Enfriado por Agua

VD-001

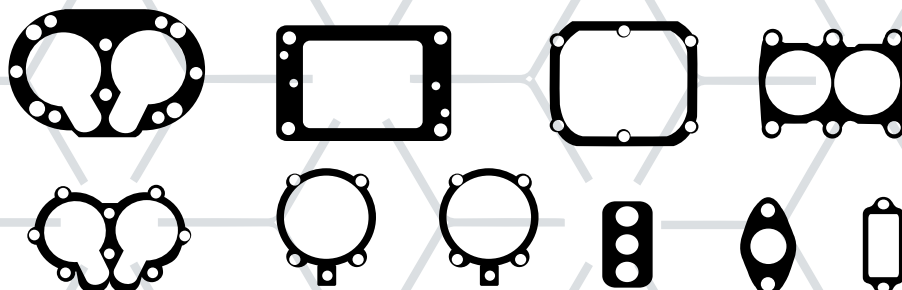

**JUEGO DE JUNTAS PARA COMPRESOR TU-FLO 400 / 229416
No. 279712 MOTOR GASOLINA Y/O PERKINS**

VD-002

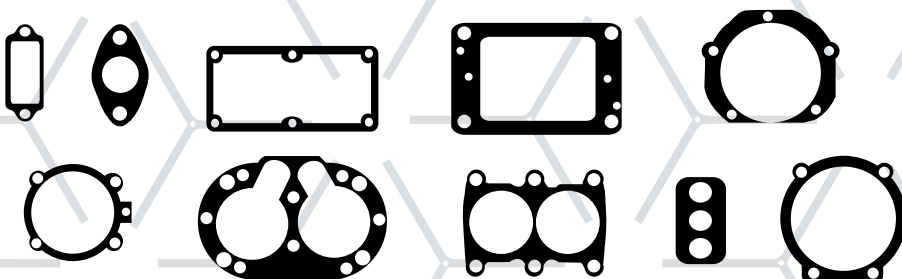

**JUEGO DE JUNTAS PARA COMPRESOR TU-FLO 500 / 229417 No. 276962
MOTOR GM DIESEL Y/O CUMMINS DIESEL**

VD-009

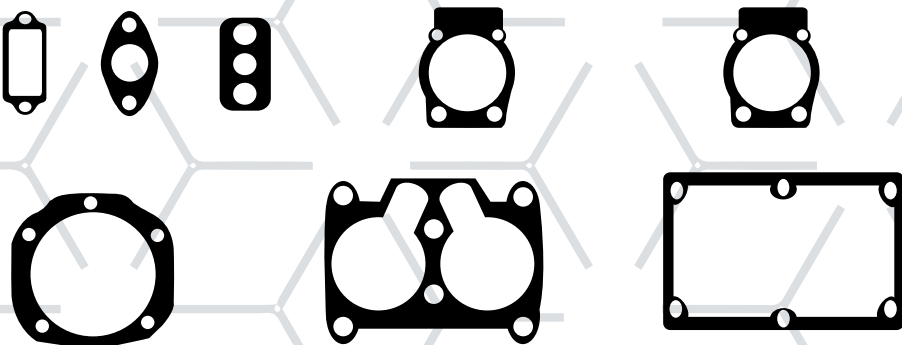

**JUEGO DE JUNTAS PARA COMPRESOR TU-FLO 501/287043
MOTOR CUMMINS DIESEL, GM DIESEL Y PERKINS DIESEL**

COMPRESORES

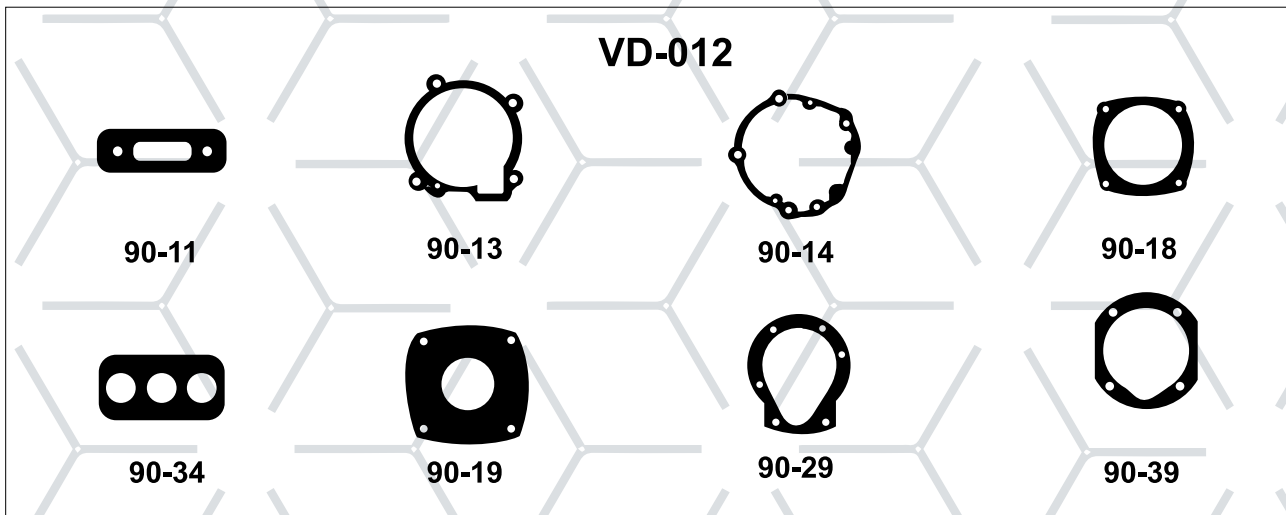

JUEGO DE JUNTAS PARA COMPRESOR CUMMINS AR / 12719 MOTOR V6 140-155 HP Y V8 185-210 HP

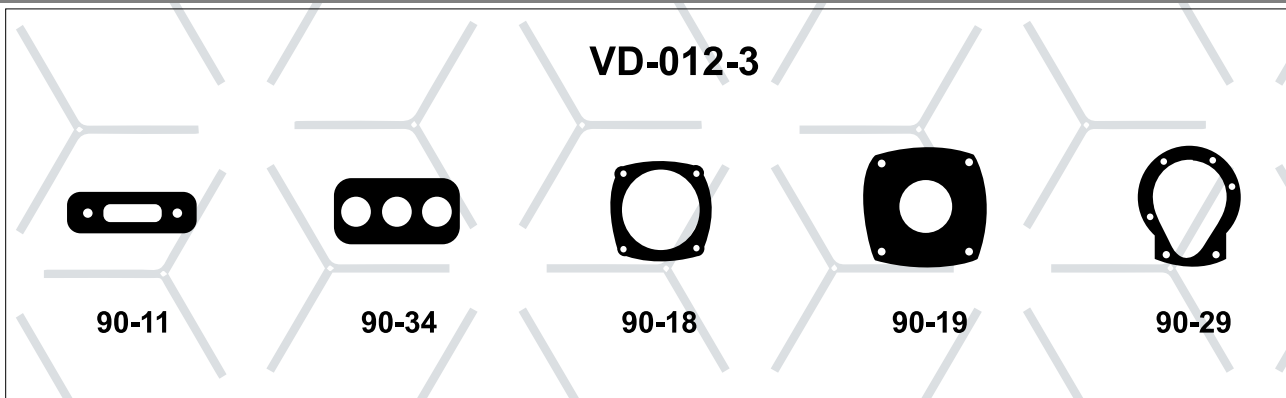

JUEGO DE JUNTAS PARA COMPRESOR CUMMINS AR / 12719 MOTOR V6 140-155 HP Y V8 185-210 HP

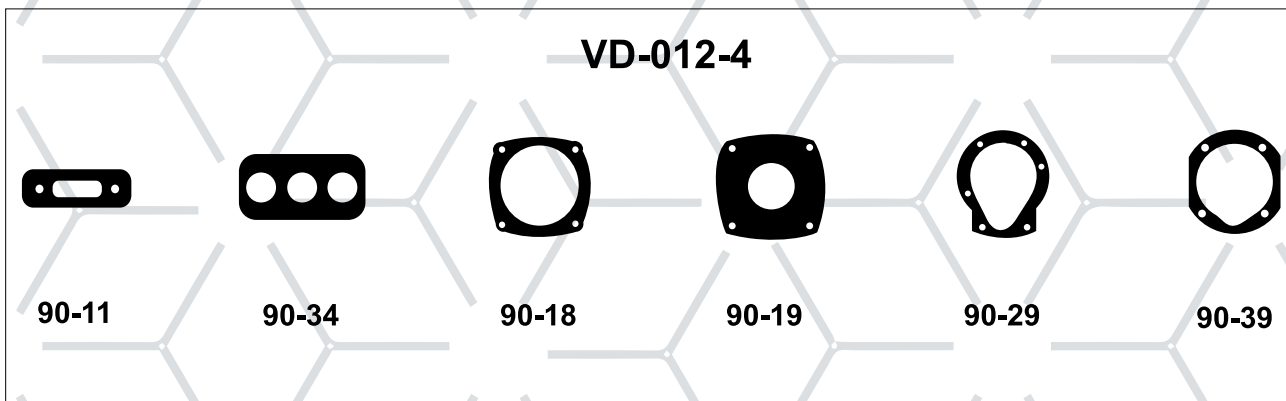

JUEGO DE JUNTAS PARA COMPRESOR CUMMINS AR / 12719 MOTOR V6 140-155 HP Y V8 185-210 HP

COMPRESORES

VD-012-350



90-11



90-18



90-19



90-29



90-34



94-7



94-12

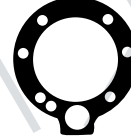

94-25

JUEGO DE JUNTAS PARA COMPRESOR CUMMINS MOTOR NTC-350

VD-055

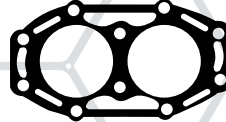
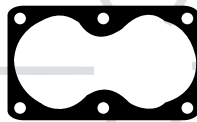

JUEGO DE JUNTAS PARA COMPRESOR MIDLAND 2" TIPO EL-740 / RN26DW

VD-056



JUEGO DE JUNTAS PARA COMPRESOR MIDLAND TIPO EL-1300 / RNT26, EL13020 2" 3/4

VD-057

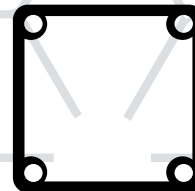
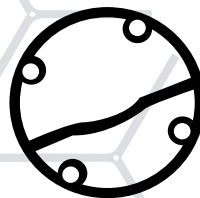
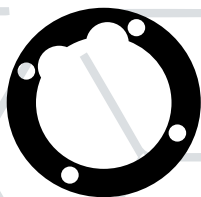

JUEGO DE JUNTAS PARA COMPRESOR WABCO W-220 ENFRIADO POR AGUA (MERCEDES BENZ)

VD-058

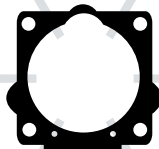
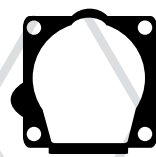
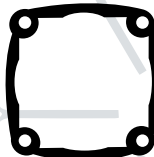
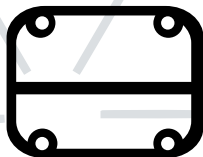

JUEGO DE JUNTAS PARA COMPRESOR KNORR 150 C. C. No. 1310501 (MINIBUS MERCEDES BENZ)

VD-059

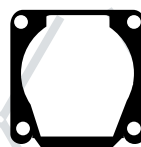
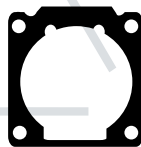
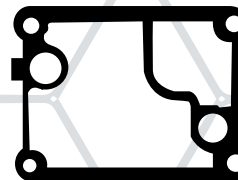
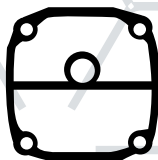

JUEGO DE JUNTAS PARA COMPRESOR BENDIX 1186736 190 C. C. No. 1189085 (MERCEDES BENZ)

VD-060

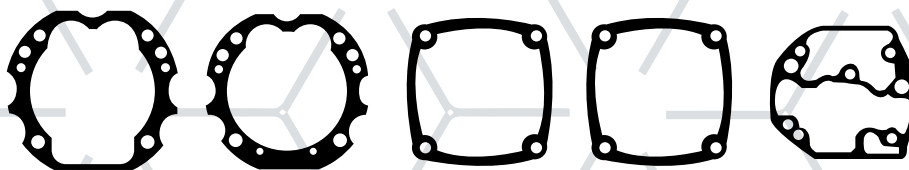

JUEGO DE JUNTAS PARA COMPRESOR KNORR 220 ENFRIADO POR AGUA (MERCEDES BENZ)

VD-061

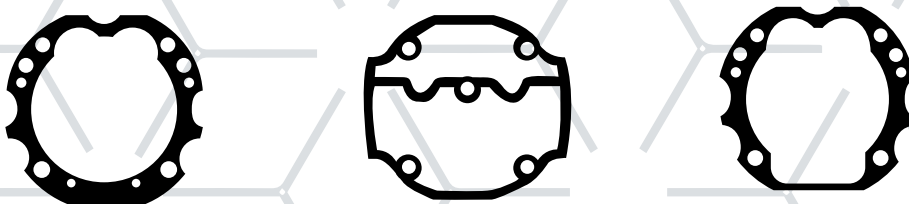

JUEGO DE JUNTAS PARA COMPRESOR WABCO 220 (MERCEDES BENZ)

VD-062

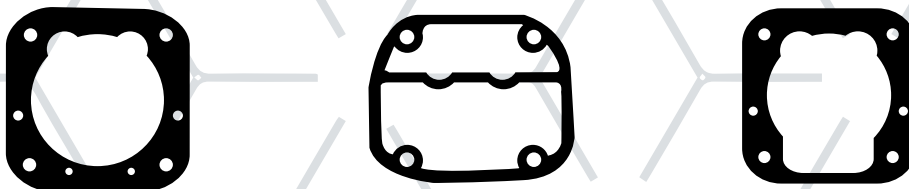

JUEGO DE JUNTAS PARA COMPRESOR WABCO 159 (MERCEDES BENZ)

VD-064

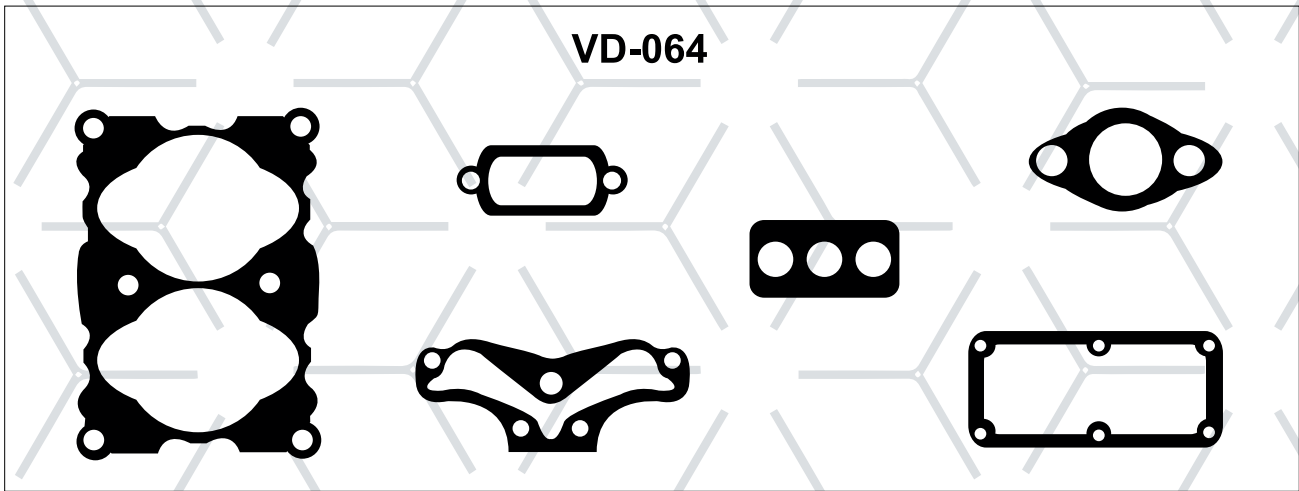

JUEGO DE JUNTAS PARA COMPRESOR BENDIX TU-FLO 550-750 No. 107516 Y No. 65457

COMPRESORES

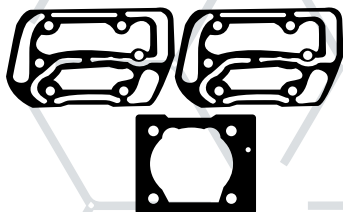

VD-079

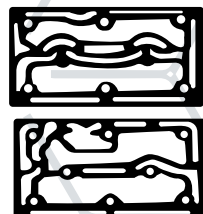

VD-080

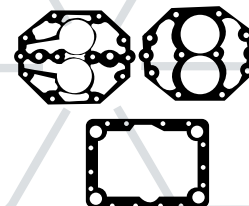

VD-081

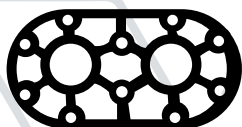

VD-082



VD-083

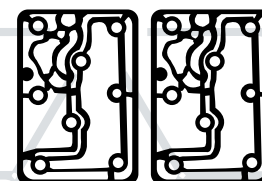

VD-084

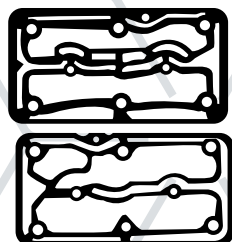

VD-085

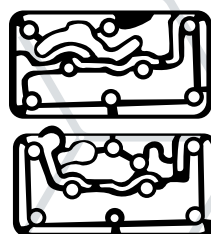

VD-086

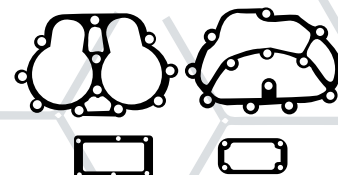

VD-087

ORIGINAL	FIRTS	APLICACIÓN
	VD-079	Juego de Juntas Compresor Electrónico N14
	VD-080	Juego de Juntas Compresor Wabco Doble Pistón para Volvo
	VD-081	Juego de Juntas Compresor York
	VD-082	Junta de Cabeza Compresor Brasileña
	VD-083	Junta de Compresor Wabco-Knorr
	VD-084	Juego de Juntas Compresor Mult-60 Cabeza Volada (412352005)
	VD-085	Juego de Juntas Compresor Wabco Doble Pistón Mercedes Benz
	VD-086	Juego de Juntas Compresor Cabeza Volada Volvo Wabco
	VD-087	Juego de Juntas Compresor Bendix Doble Pistón

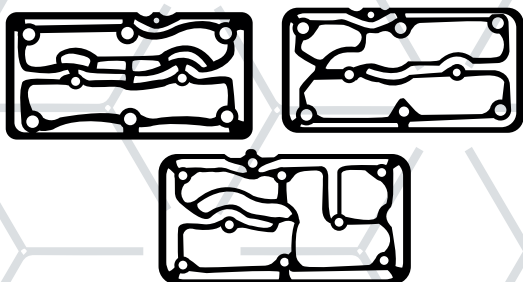

VD-088

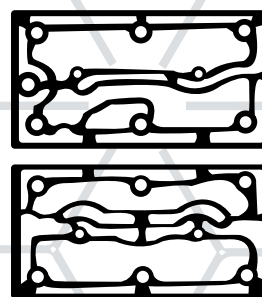

VD-089

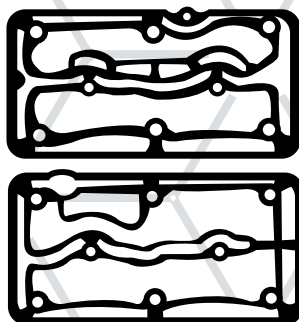

VD-090

ORIGINAL	FIRTS	APLICACIÓN
	VD-088	Juego de Juntas Compresor Wabco Doble Pistón Mercedes Benz
	VD-089	Juego de Juntas Compresor Wabco Doble Pistón Volvo
	VD-090	Juego de Juntas Compresor Wabco Doble Pistón Enfriado por Agua

CONTÁCTANOS

ventas.firts@gmail.com
contacto@firtsdiesel.com

☎ 01 779 796 3721

☎ 01 779 796 7333

www.firtsdiesel.com

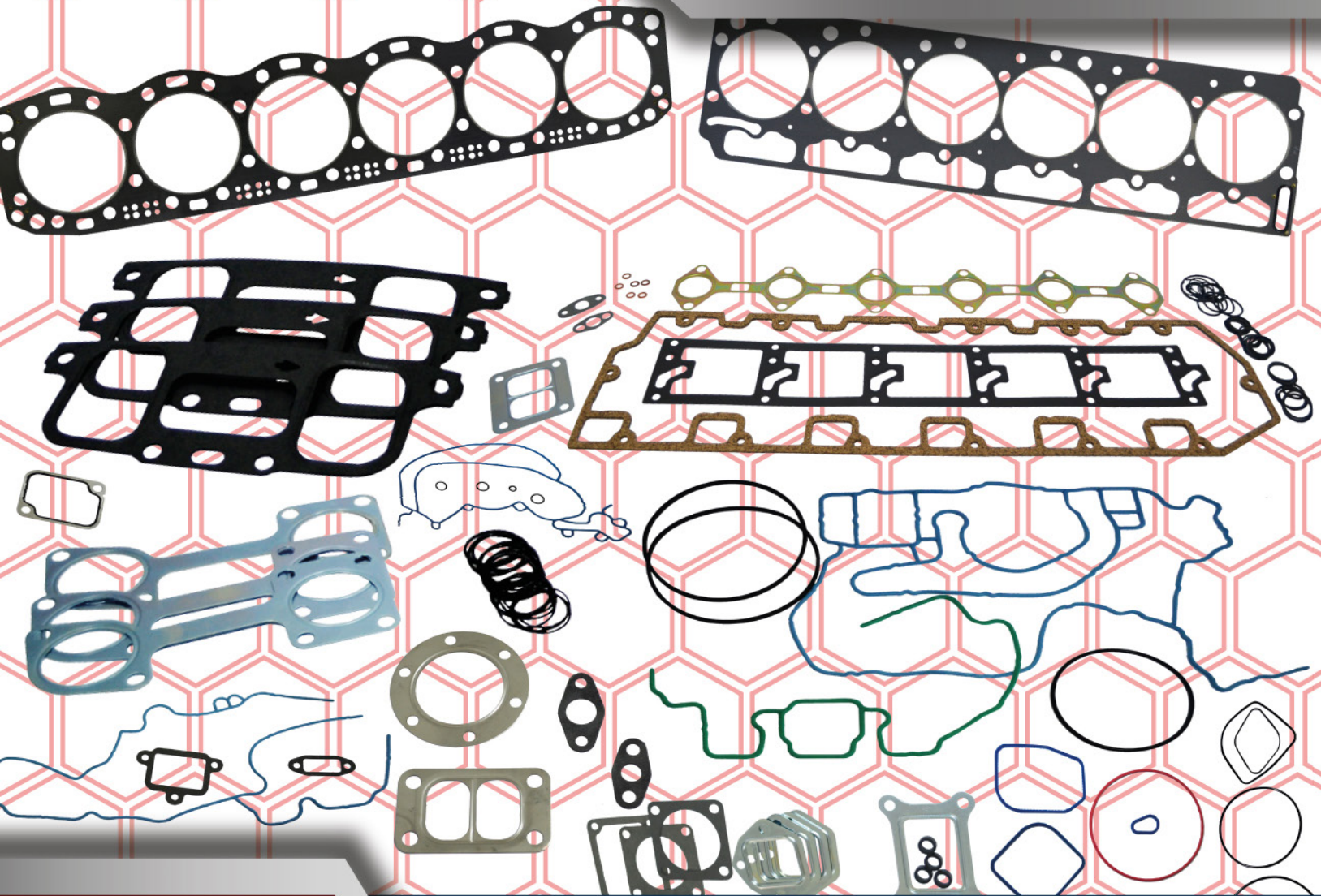

EMPAQUES AUTOMOTRICES FIRTS

