

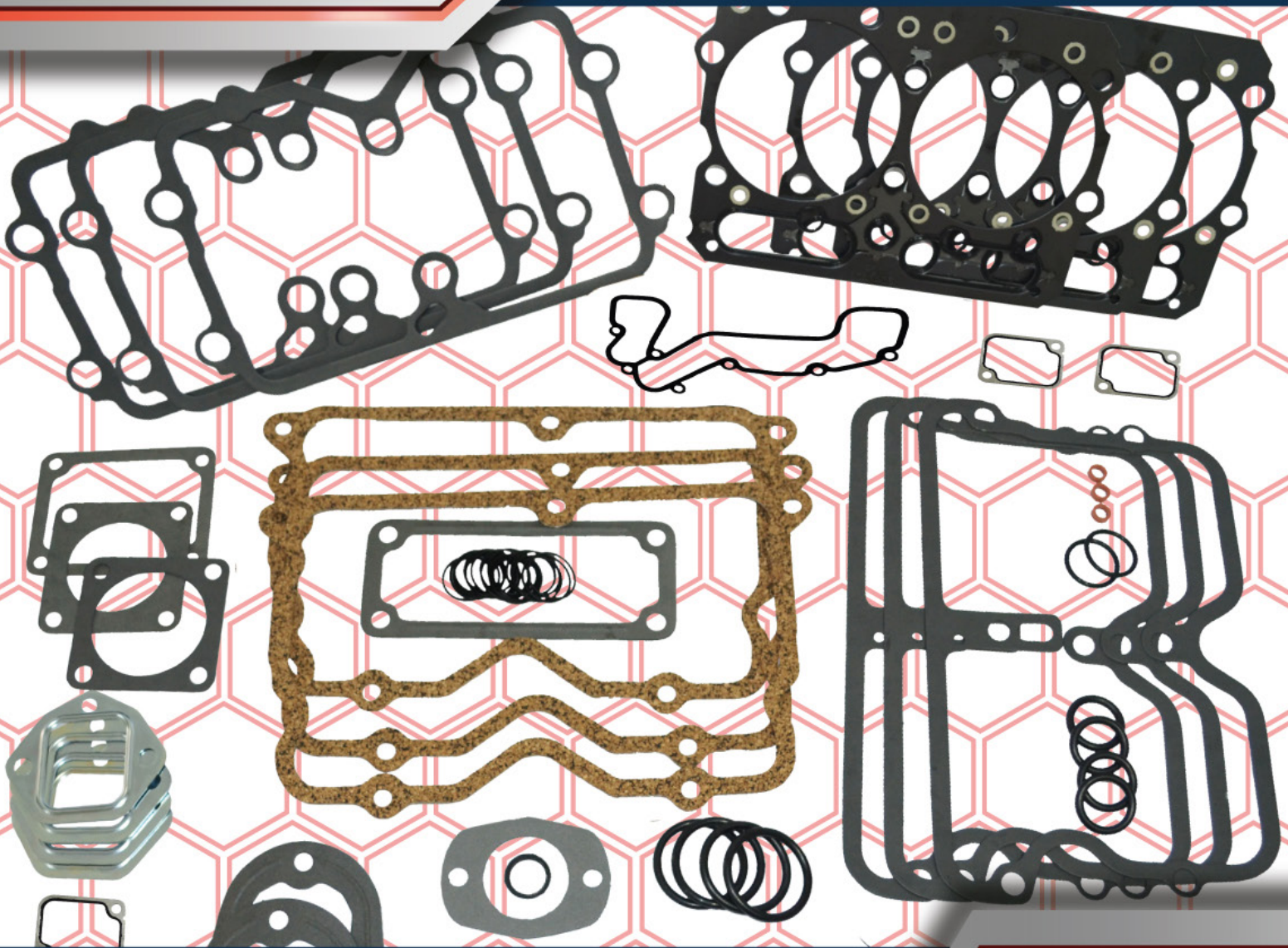

CATÁLOGO DIESEL



EMPAQUES Y JUNTAS PARA PROFESIONALES

NAVISTAR[®]



NAVISTAR®

NAVISTAR

NAVISTAR DT-360 Y DT 466

JUEGO DE JUNTAS 67

PIEZAS SUELTAS 70

NAVISTAR DT 466 NGD (MECÁNICO Y ELECTRICO)

JUEGO DE JUNTAS 74

PIEZAS SUELTAS 75

VARIOS DIESEL77

VD-065	Juegos de Ligas para Distribución Navistar NGD DT-466
VD-066	Juego de Juntas para Montaje del Turbo Navistar DT-466, DT-408, NGD DT-466
VD-067	Juego de Ligas para Enfriador de Aceite Motor NGD DT-466, DT-408, 530
VD-068	Juego de Ligas para Distribución Navistar NGD DT-466 (Electrónico)
VD-069-6	Kit de Afinación para 6 Inyectores Navistar NGD (Electrónico)
VD-069-1	Kit de Afinación para 1 Inyector Navistar NGD (Electrónico)
VD-070	Juego de Juntas para Enfriador de Aceite DT--360 y DT-466 (hasta 1993)

DT-360, DT- 466 NGD MECÁNICO Y ELECTRÓNICO

NAVISTAR	FIRTS	APLICACIÓN
AL18008973 C93	MJ-2104-1	Medio Juego Superior Navistar DT-466 185-210 HP
AL674399 C96	MJ-2104-2	Medio Juego Inferior Navistar DT-466 185-210 HP
AL1810036 C95	MJ-2105-1	Medio Juego Superior Navistar DT-360 170 HP
AL674399 C96	MJ-2105-2	Medio Juego Inferior Navistar DT-360 170 HP
AL1824970 C98	MJ-2106-1E	Medio Juego Superior Motor Navistar 466 Electrónico
AL1822328 C95	MJ-2106-1M	Medio Juego Superior Motor Navistar 466 Mecánico
	MJ-2106-2E	Medio Juego Inferior Navistar NGD Electrónico
	MJ-2106-2M	Medio Juego Inferior Navistar NGD Mecánico

NAVISTAR

**MJ-2105-1
AL1810036C95
JUEGO SUPERIOR NAVISTAR DT-360**
**MJ-2105-2
AL674399C96
JUEGO INFERIOR NAVISTAR DT-360**

Original	Firts	Cantidad	Original	Firts	Cantidad
670079C2	214-3	1	675808C2	214-7	1
253660R2	214-4	1	675816C2	214-8	1
675384C2	214-5	1	675398C2	214-9	1
1809961C2	CA-2105	1	675609C2	214-10	1
670073C2	ES-2104-T	1	676988C2	214-11	1
682198C2	MU-2105-A	1	683791C2	214-12	1
1810169C2	MU-2105-E	1	675813C2	214-13	1
675389C1	PS-2105	1	675812C2	214-14	1
675447C1	ROLDANA	6	671821C2	214-16	1
677692C1	ROLDANA	6	1802867C2	214-17	1
682810C1	SELLO	6		214-18	1
681234C1	SELLO	12	682945C3	214-19	1
			675513C1	214-20	2
			1810699C4	214-21	1
			1910510C3	214-22	1
			671825C4	CJ-2105	1
				O'RING	1
				O'RING	1
				O'RING	1
				O'RING	4
				O'RING	2
				ROLDANA	1
				ROLDANA	1

MJ-2104-1 AL1808973C93 JUEGO SUPERIOR NAVISTAR DT-466			MJ-2104-2 AL674399C96 JUEGO INFERIOR NAVISTAR DT-466		
Original	Firts	Cantidad	Original	Firts	Cantidad
686181C2	214-1	1	675808C2	214-7	1
673341C2	214-2	1	675816C2	214-8	1
670079C2	214-3	1	675398C2	214-9	1
253660R2	214-4	1	675609C2	214-10	1
675384C2	214-5	1	676988C2	214-11	1
673973C4	214-6	1	683791C2	214-12	1
1806226C3	CA-2104	1	675813C2	214-13	1
670073C2	ES-2104-T	1	675812C2	214-14	1
	JUNTA	1	671821C2	214-16	1
682199C2	MU-2104-A	1	1802867C2	214-17	1
1809784C1	MU-2104-E	6		214-18	1
675109C3	PS-2104	1	682945C3	214-19	1
675477C1	ROLDANA	6	675513C1	214-20	2
677692C1	ROLDANA	6	1810699C4	214-21	1
681234C1	SELLO	12	1810510C3	214-22	1
682810C1	SELLO	1	671827C2	CJ-2104	1
				O'RING	1
				O'RING	1
				O'RING	1
				O'RING	4
				O'RING	2
				ROLDANA	1
				ROLDANA	1



MOTORES DT-360 Y DT-466

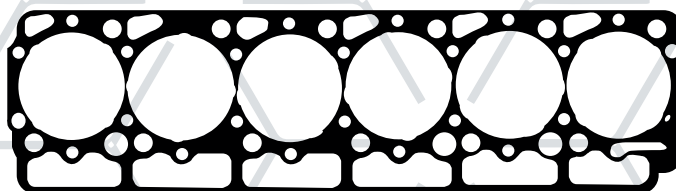

CA-2104

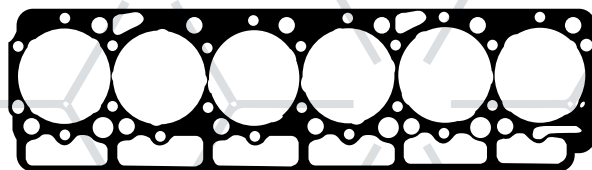

CA-2105



PS-2104



PS-2105

NAVISTAR

ORIGINAL	FIRTS	APLICACIÓN
1806226C3	CA-2104	Junta de Cabeza para Motor NAVISTAR DT-466
1809967C2	CA-2105	Junta de Cabeza para Motor NAVISTAR DT-360
675109C3	PS-2104	Junta Tapa de Punterías para Motor NAVISTAR DT-466 (Corcho)
	PS-2104-H	Junta Tapa de Punterías para Motor NAVISTAR DT-466 (Hule)
675389C1	PS-2105	Junta Tapa de Punterías para Motor NAVISTAR DT-360 (Corcho)
	PS-2105-H	Junta Tapa de Punterías para Motor NAVISTAR DT-360 (Hule)

MOTORES DT-360 Y DT-466

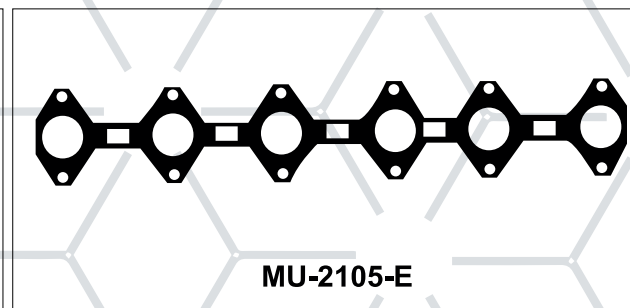
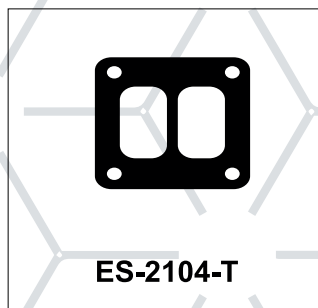
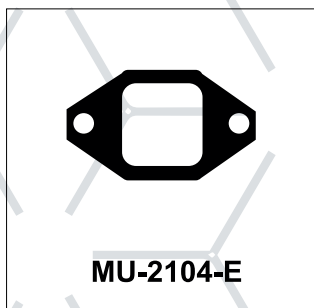
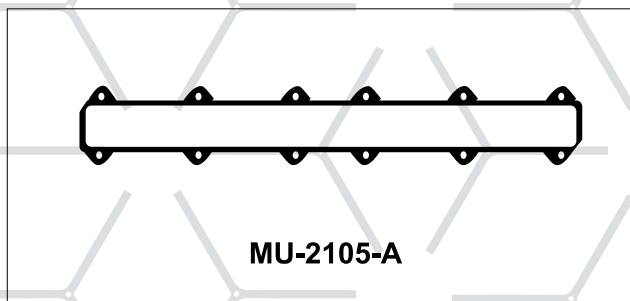
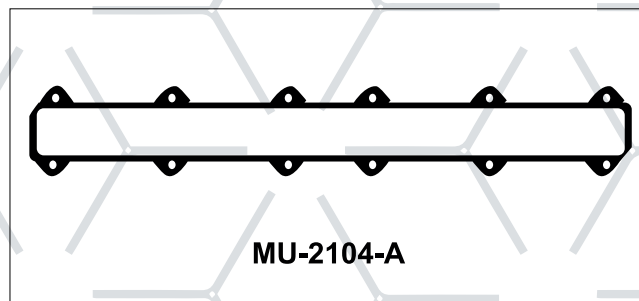
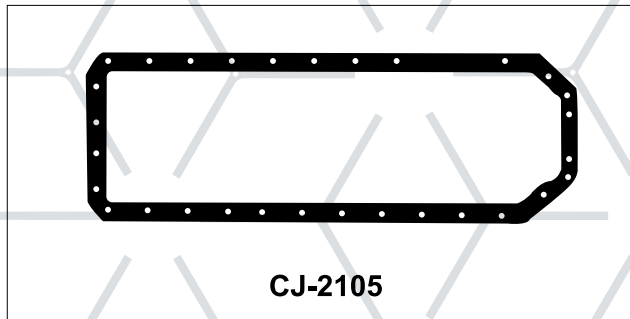
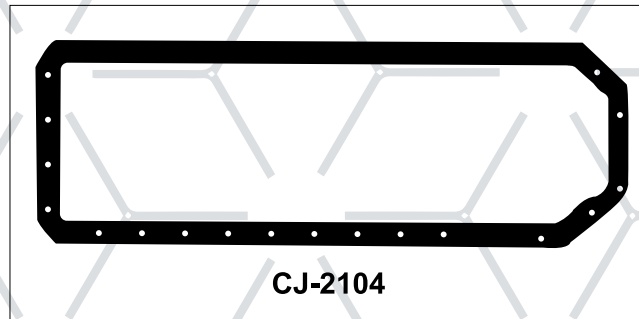

NAVISTAR

ORIGINAL	FIRTS	APLICACIÓN
671827C2	CJ-2104	Junta Cárter para Motor NAVISTAR DT-466
671825C4	CJ-2105	Junta Cárter para Motor NAVISTAR DT-360
682199C2	MU-2104-A	Junta Múltiple de Admisión Motor NAVISTAR DT-466
682196C2	MU-2105-A	Junta Múltiple de Admisión Motor NAVISTAR DT-360
1809784C1	MU-2104-E	Juntas Múltiple Escape Motor NAVISTAR DT-466
1810169C2	MU-2105-E	Junta Múltiple Escape Motor DT-360
670073C2	ES-2104-T	Junta Turbocargador Motor DT-360 y DT-466

MOTORES DT-360 Y DT-466

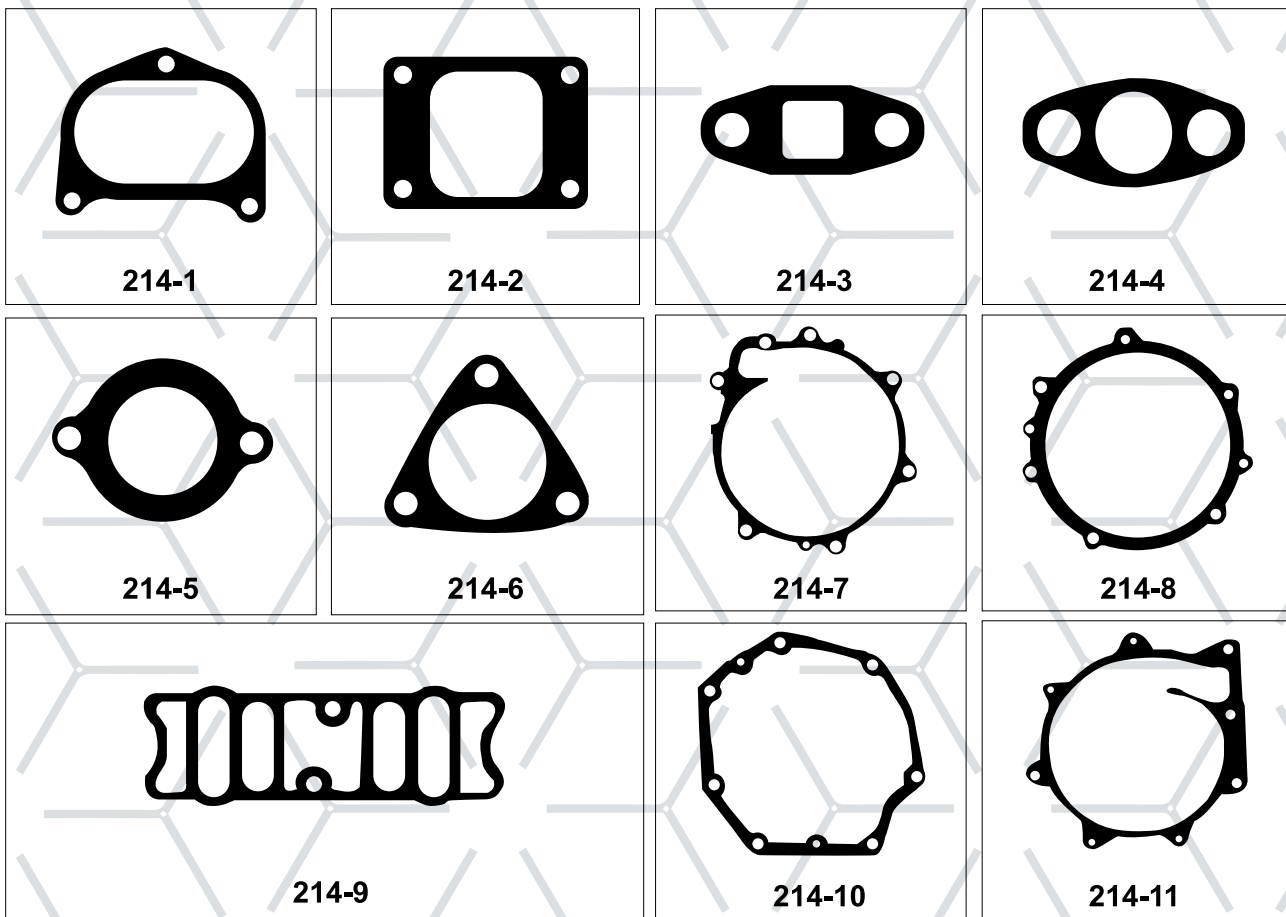

NAVISTAR

ORIGINAL	FIRTS	APLICACIÓN
686181C2	214-1	Junta Codo Intercambiador de Calor Serie 143536 Motor DT-466
673341C2	214-2	Junta Motor DT- 466
670079C2	214-3	Junta Tubo de Aceite Motor DT-360 y DT-466
253660R2	214-4	Junta Tubo de Aceite Motor DT-360 y DT-466
675384C2	214-5	Junta Termostato Motor DT-360 y DT-466
673973C4	214-6	Junta Soporte Tubo Escape Motor DT-466
675808C2	214-7	Junta Bomba de Agua Motor DT-360 y DT-466 (Bomba Grande)
675816C2	214-8	Junta Tapa Bomba Inyección Motor DT-360 y DT-466
675398C2	214-9	Junta Tapa Filtro de Aceite Motor DT-360 y DT-466
675609C2	214-10	Junta Adaptadora Tapa de Inyección Motor DT-360 y DT-466
676988C2	214-11	Junta Bomba de Agua Motor DT-360 y DT-466 (Bomba Chica)

DT-360 Y DT-466

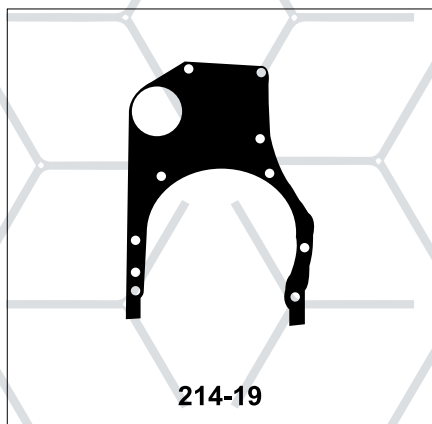
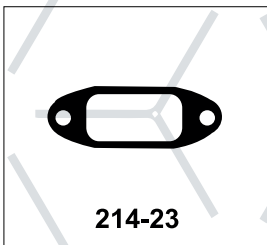
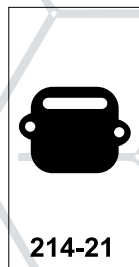
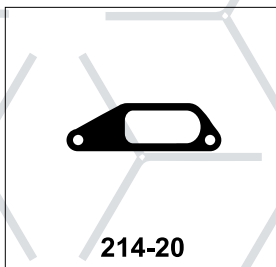
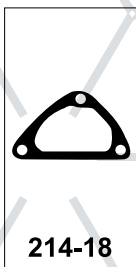
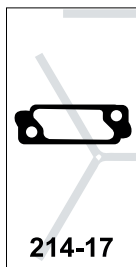
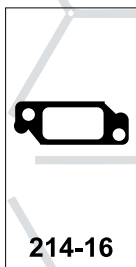
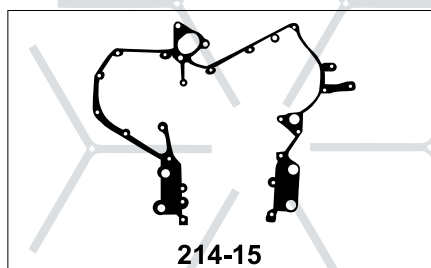
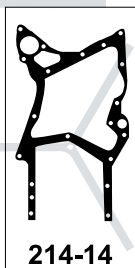
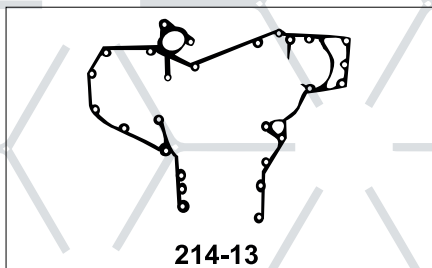
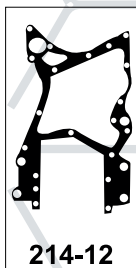

ORIGINAL	FIRTS	APLICACIÓN
683791C2	214-12	Junta Cubierta Frontal Motor DT-466
675813C2	214-13	Junta Cubierta Frontal Motor DT-466
675812C2	214-14	Junta Cubierta Frontal Motor DT-466
677082C3	214-15	Junta Cubierta Frontal Motor DT-466
671821C2	214-16	Junta Tubo Bomba de Aceite DT-466
1802867C2	214-17	Junta Tubo Bomba de Aceite DT-466
	214-18	Junta
682945C3	214-19	Junta Tapa Volante Motor DT-360 y DT-466
675513C1	214-20	Junta Enfriador de Aceite Motor DT-360 y DT-466
1810699C4	214-21	Junta Respiradero Motor DT-360 y DT-466
1810510C3	214-22	Junta Cubierta Frontal Motor DT-360
1816722C2	214-23	Junta Bomba de Aceite

NAVISTAR

**MJ-2106-1E
AL1824970 C98
JUEGO SUPERIOR NAVISTAR 466
ELECTRÓNICO**

Original	Firts	Cantidad
1817562C4	CA-2106	1
670073C2	ES-2104-T	1
1820936C1	JUNTA	1
670073C2	JUNTA	1
1822577C1	MU-2106-A	1
1825436C1	MU-2106-E	1
1825602C91	PS-2106-Y	1
675447C1	ROLDANA	6
	SELLOS	6
	SELLOS	6
	O'RING	14

**MJ-2106-1M
AL1822328 C95
JUEGO SUPERIOR NAVISTAR 466
MECÁNICO**

Original	Firts	Cantidad
1817562C4	CA-2106	1
670073C2	ES-2104-T	1
1820936C1	JUNTA	1
670073C2	JUNTA	1
1825436C1	MU-2106-E	1
1817510C1	PS-2106-X	1
675447C1	ROLDANA	6
	SELLOS	6
	O'RING	1

**MJ-2106-2E
MEDIO JUEGO INFERIOR NAVISTAR NGD
ELECTRÓNICO**

Original	Firts	Cantidad
1824984 C94	VD-068	1
1823182 C91	VD-067	1
1817562 C4	CJ-106	1

**MJ-2106-2M
MEDIO JUEGO INFERIOR NAVISTAR NGD
MECÁNICO**

Original	Firts	Cantidad
1824984 C98	VD-065	1
1823182 C91	VD-067	1
1817562 C4	CJ-106	1

NGD MOTORES 466 Y 530 MECÁNICO Y ELECTRÓNICO

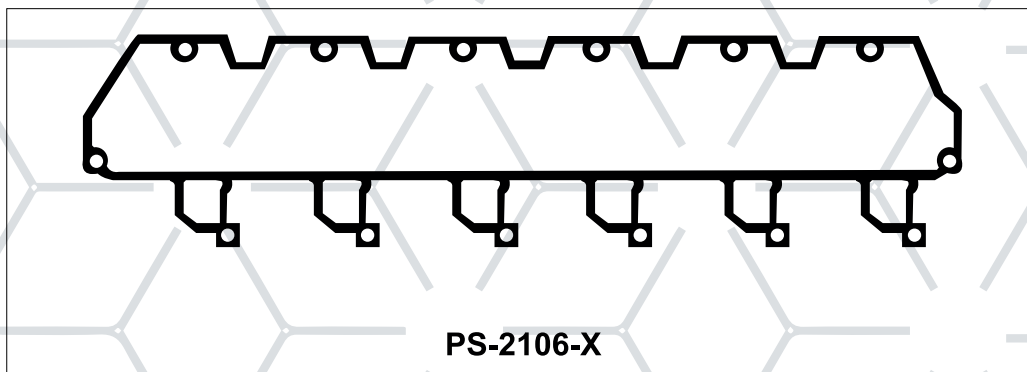
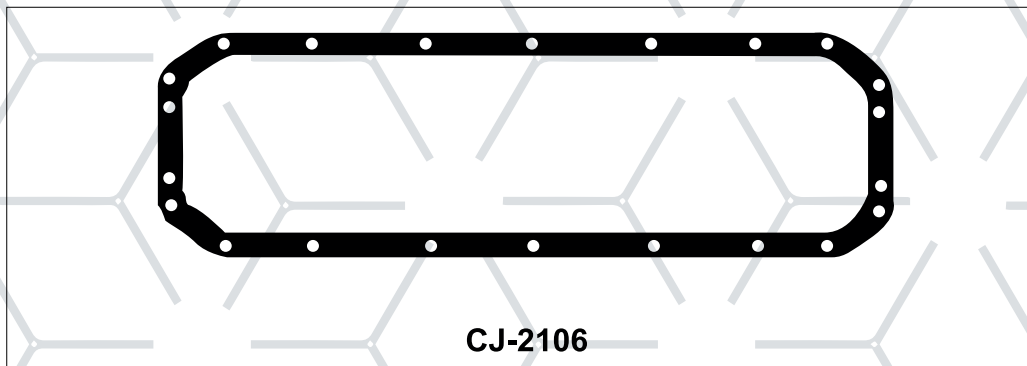
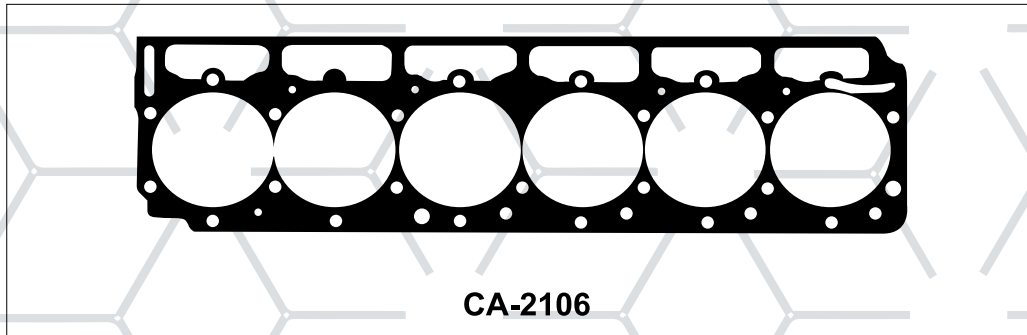

NAVISTAR

ORIGINAL	FIRTS	APLICACIÓN
1817562C4	CA-2106	Junta de Cabeza DT-408, DT-466, 530, 466-E y 530-E
1856587C1	CJ-2106	Junta Cáster Motor NGD
1817510C1	PS-2106-X	Junta Tapa de Punterías DT- 466, 530 Mecánico

NGD MOTORES 466 Y 530 MECÁNICO Y ELECTRÓNICO

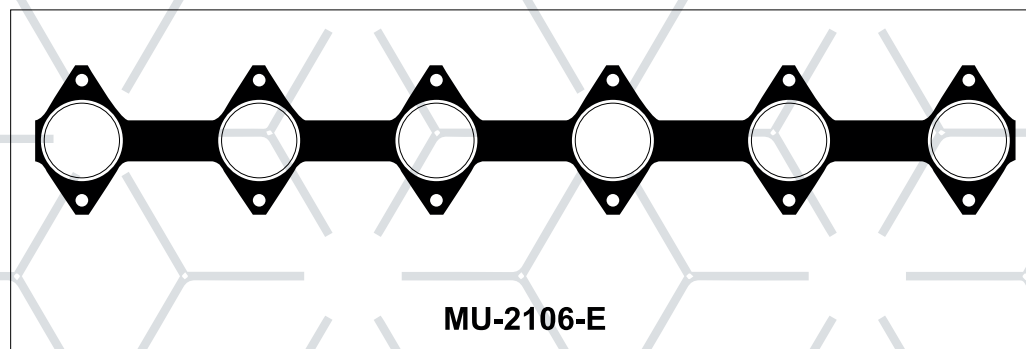
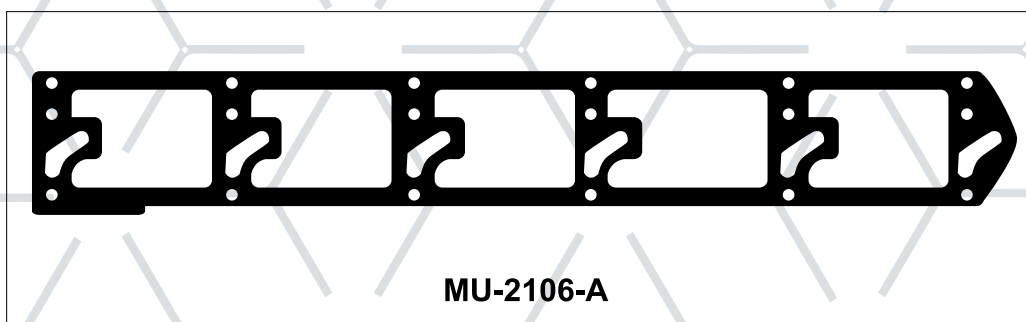
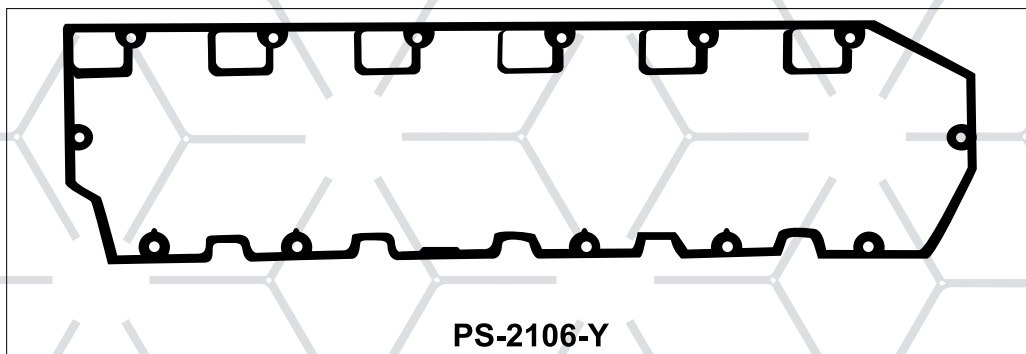

NAVISTAR

ORIGINAL	FIRTS	APLICACIÓN
1825602C91	PS-2106-Y	Junta Tapa de Punterías DT-466, 530 Electrónico
1822577C1	MU-2106-A	Junta Múltiple de Admisión DT-466, 530 Electrónico
1825436C1	MU-2106-E	Junta Múltiple de Escape DT-408, DT-466, 530, 466-E, 530-E

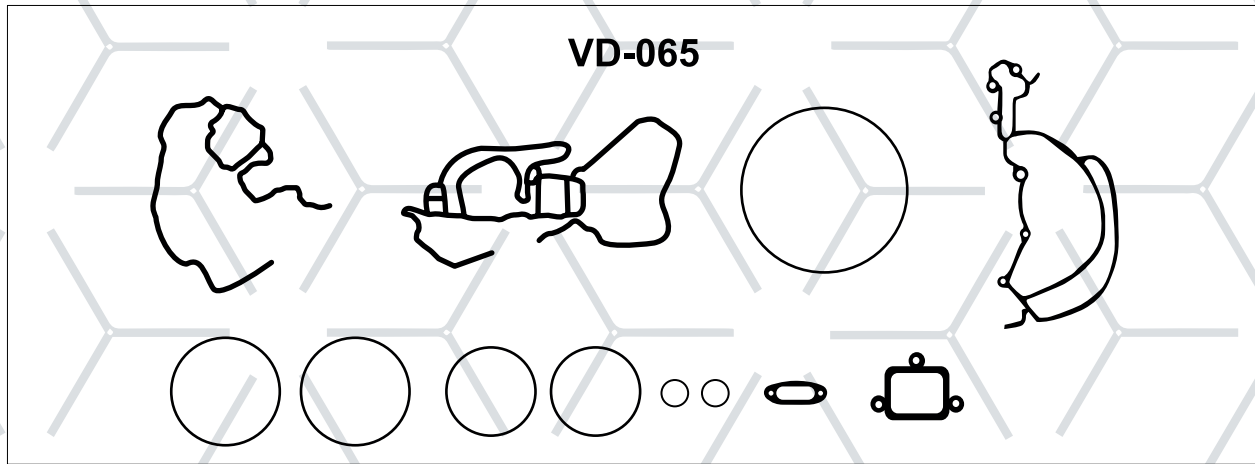

JUEGO DE LIGAS PARA DISTRIBUCIÓN NAVISTAR NGD DT-446, MECANICO
(182 2365C98)

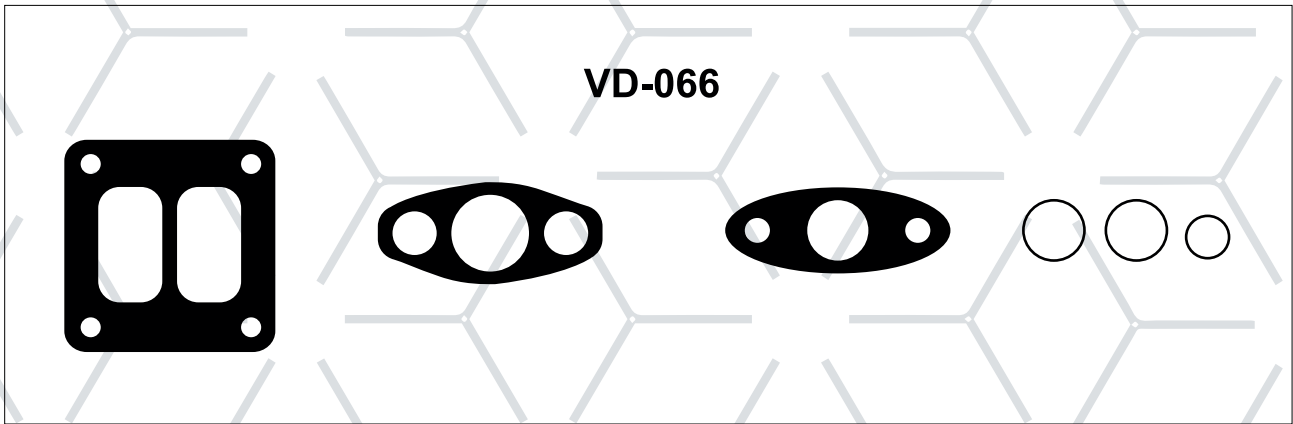

JUEGO DE JUNTAS PARA MONTAJE DEL TURBO NAVISTAR DT-466, DT-408, 530, DT-466 NGD
(1823 181C91)

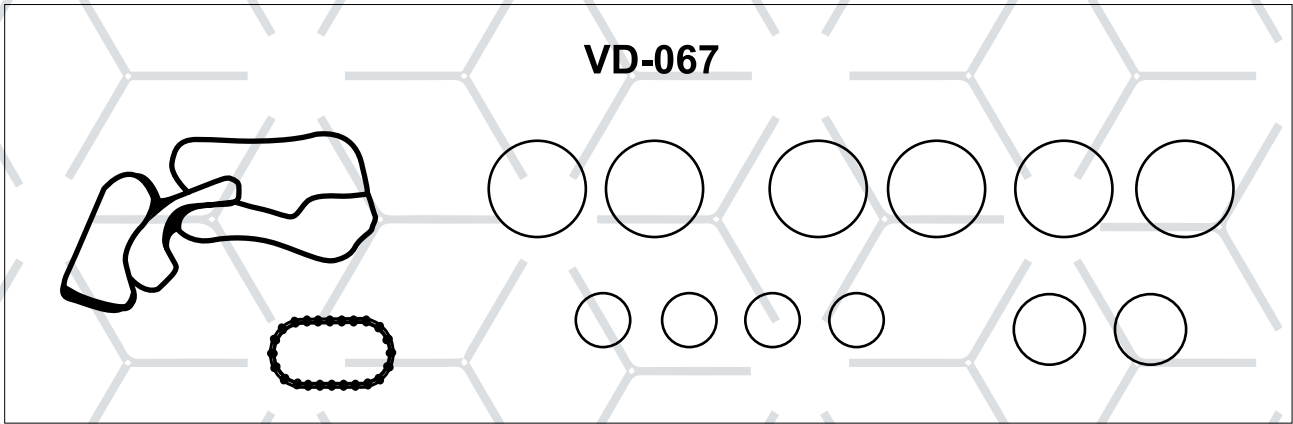

JUEGO DE SELLOS PARA ENFRIADOR DE ACEITE NAVISTAR NGD DT-466, DT-408, 530
(1823 182C91)

NAVISTAR

VD-068

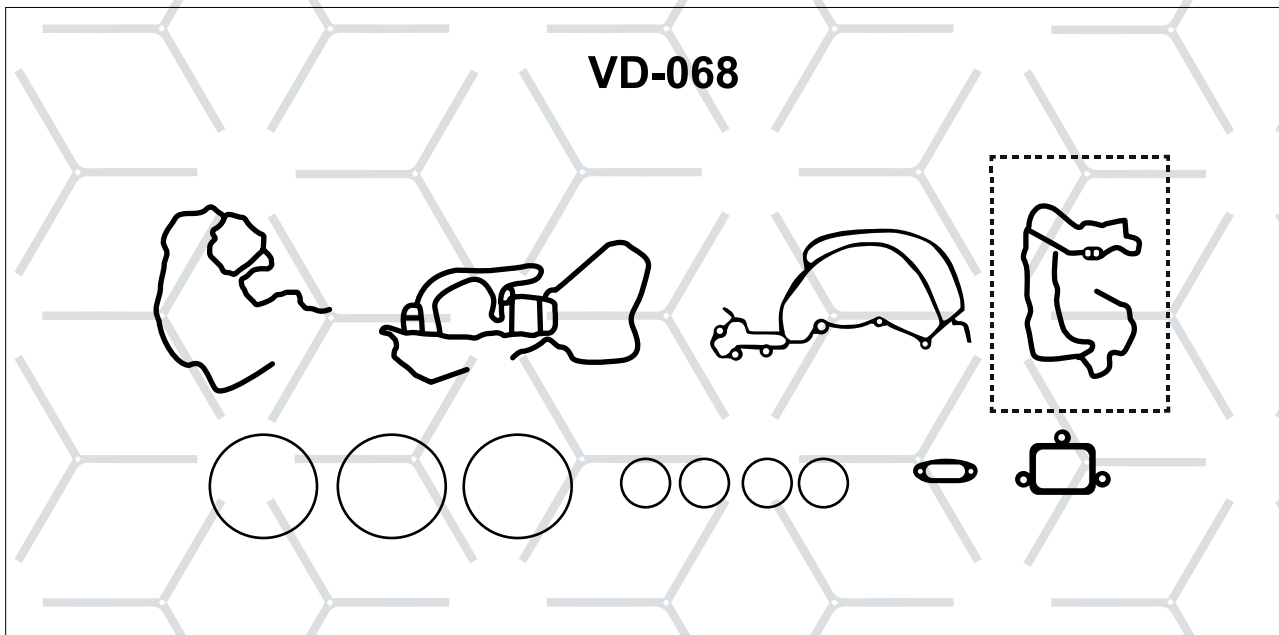

**JUEGO DE LIGAS PARA DISTRIBUCIÓN NAVISTAR NGD DT-466 ELECTRÓNICO
(182 4984C94)**

VD-069-6

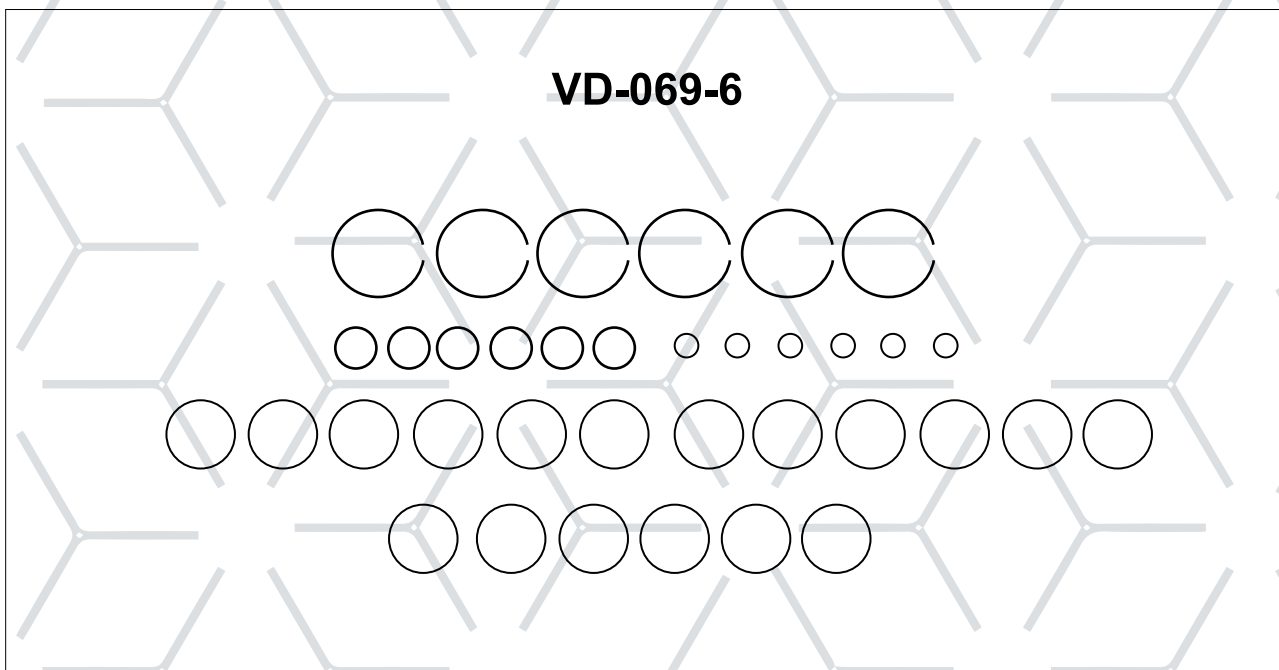

**KIT DE AFINACIÓN PARA 6 INYECTORES NAVISTAR NGD ELECTRÓNICO 466 Y 530
(1833 564C92)**

VD-069-1

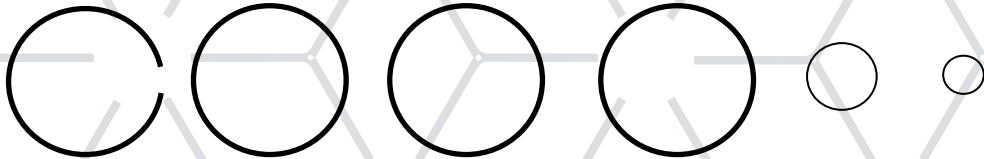

KIT DE AFINACIÓN PARA 6 INYECTORES NAVISTAR NGD ELECTRÓNICO 466 Y 530
(1833 564C92)

VD-070



O'RING



214-20



214-20

NAVISTAR

JUEGO DE JUNTAS PARA ENFRIADO DE ACEITE DT 360 Y DT 466 (HASTA 1993)

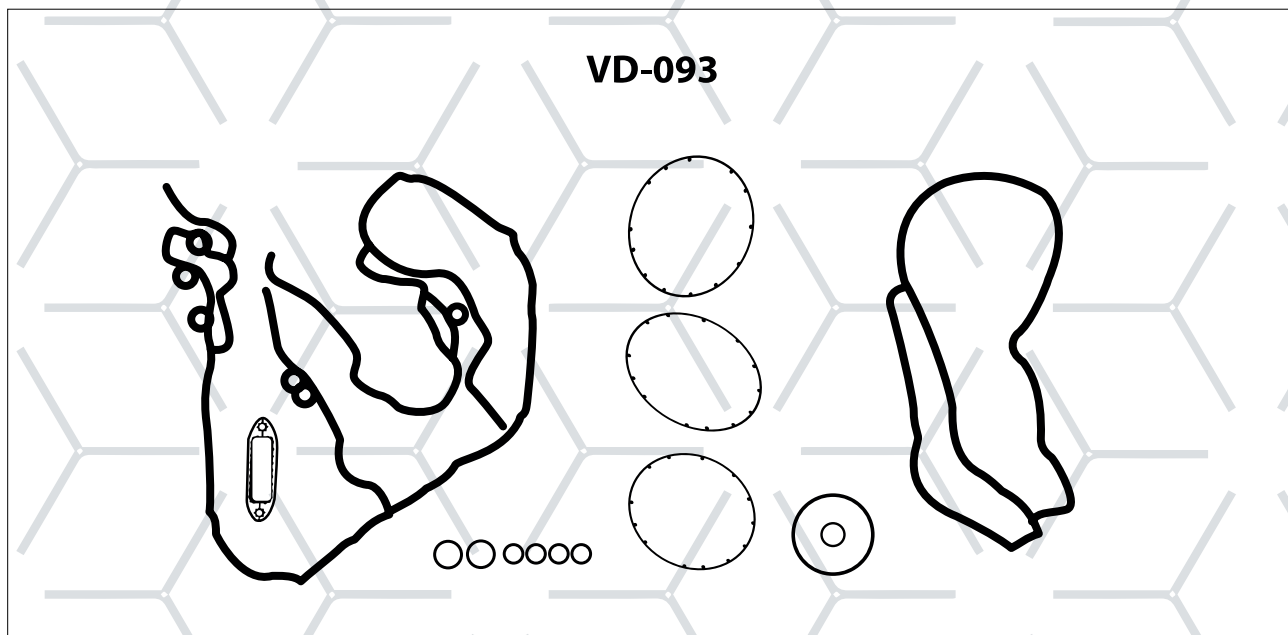

JUEGO DE LIGAS DISTRIDUCIÓN MAXX FORCE NAVISTAR

NAVISTAR

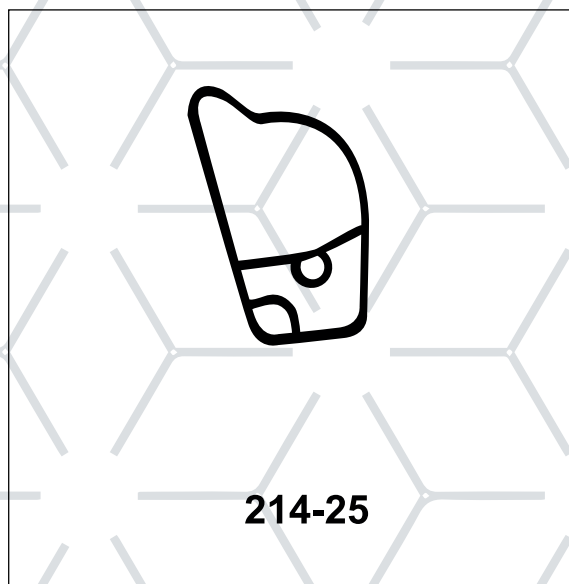
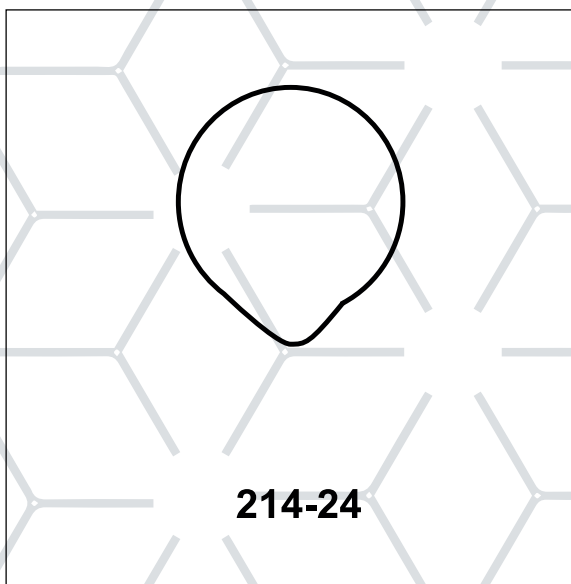

ORIGINAL	FIRTS	APLICACIÓN
1818727C1	214-24	Liga Base de Compresor Navistar
1825685C1	214-25	Liga Bomba de Alta Presión Navistar

CONTÁCTANOS

ventas.firts@gmail.com
contacto@firtsdiesel.com

☎ 01 779 796 3721

☎ 01 779 796 7333

www.firtsdiesel.com

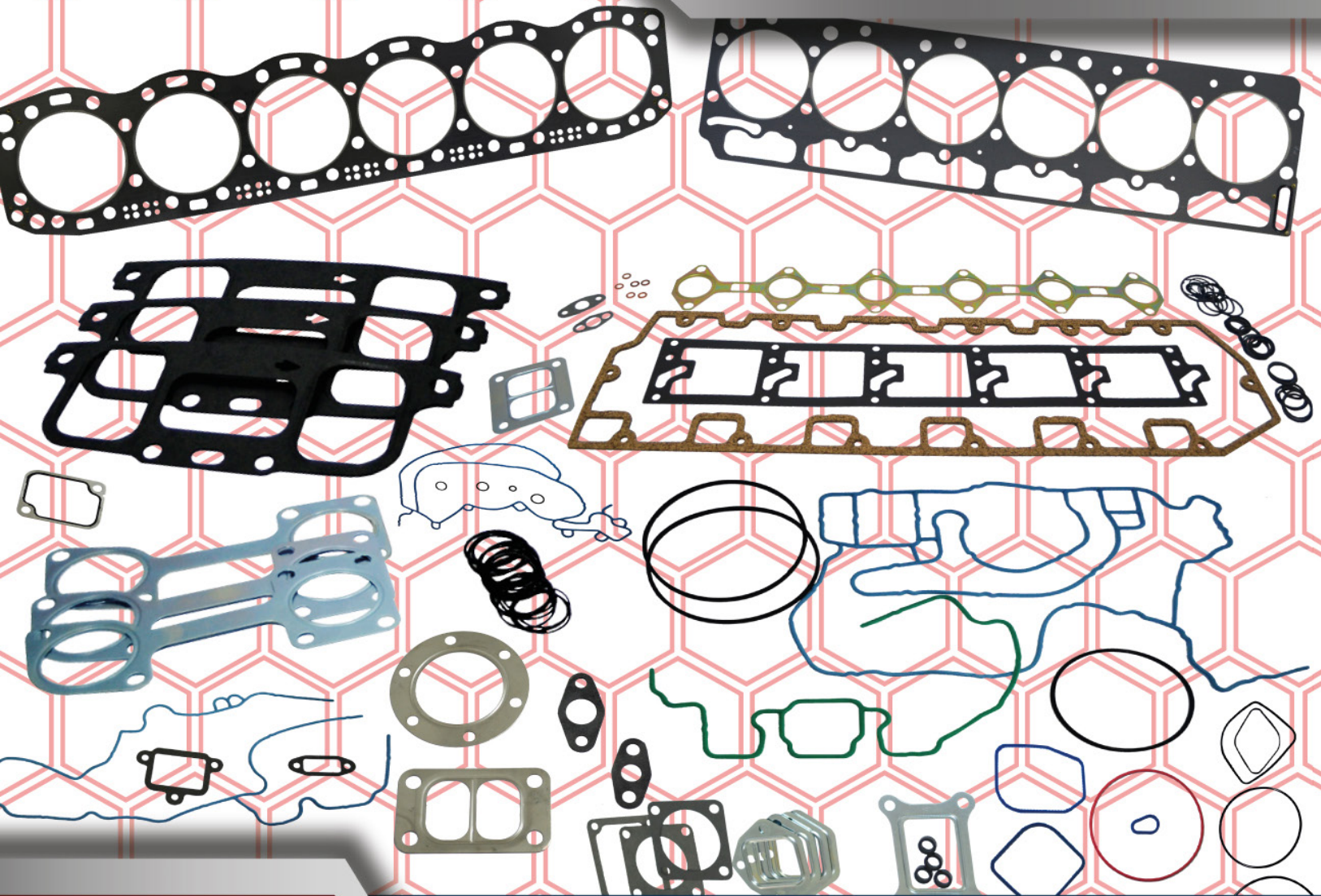

EMPAQUES AUTOMOTRICES FIRTS

