

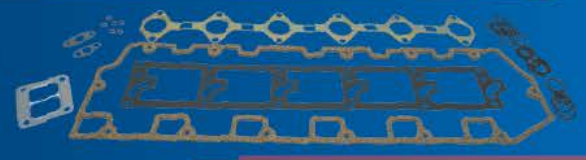

CATÁLOGO DIESEL

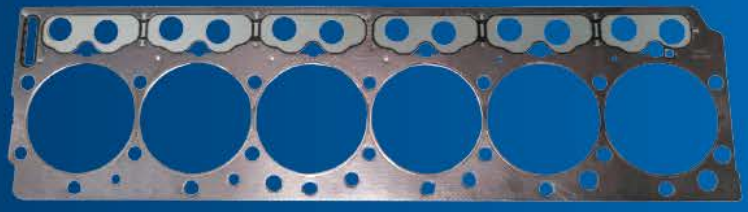

**EMPAQUES Y JUNTAS
PARA PROFESIONALES**

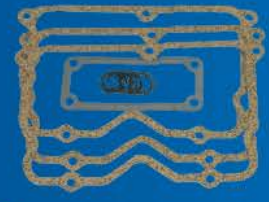



PERKINS

PIEZAS SUELTAS	11
VARIOS DIESEL	15
DJ-802	Juegos de Juntas para Distribución
VD-802-T	Juego de Juntas Turbo Cargador

MOTOR 6-354 FASE II



PS-801



MU-801-A



MU-801-E

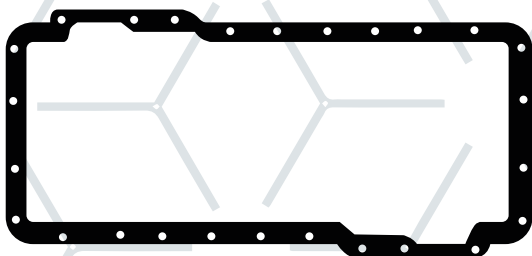

CJ-801

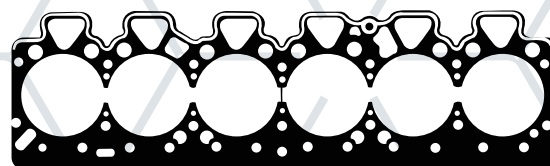

CA-802



80-20

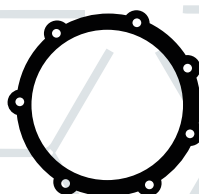

80-21



80-31



80-55

PERKINS

ORIGINAL	FIRTS	APLICACIÓN
36811427	PS-801	Junta Tapa Puntería
36816702	CJ-801	Junta para Cáster
	MU-801-A	Juego de Juntas Múltiple de Admisión
36862129	MU-801-E	Juego de Juntas Múltiple Escape
36862124		
	CA-802	Junta de Cabeza Perkins Fase II
36825107	80-20	Junta Tapa Adaptador Tacómetro
36826107	80-21	Junta Tapa de Engrane Árbol de Levas
3684-R003	80-31	Junta Cuerpo Salida de Agua
36866426	80-55	Junta Soporte Compresor

MOTOR 6-354 FASE II

PERKINS

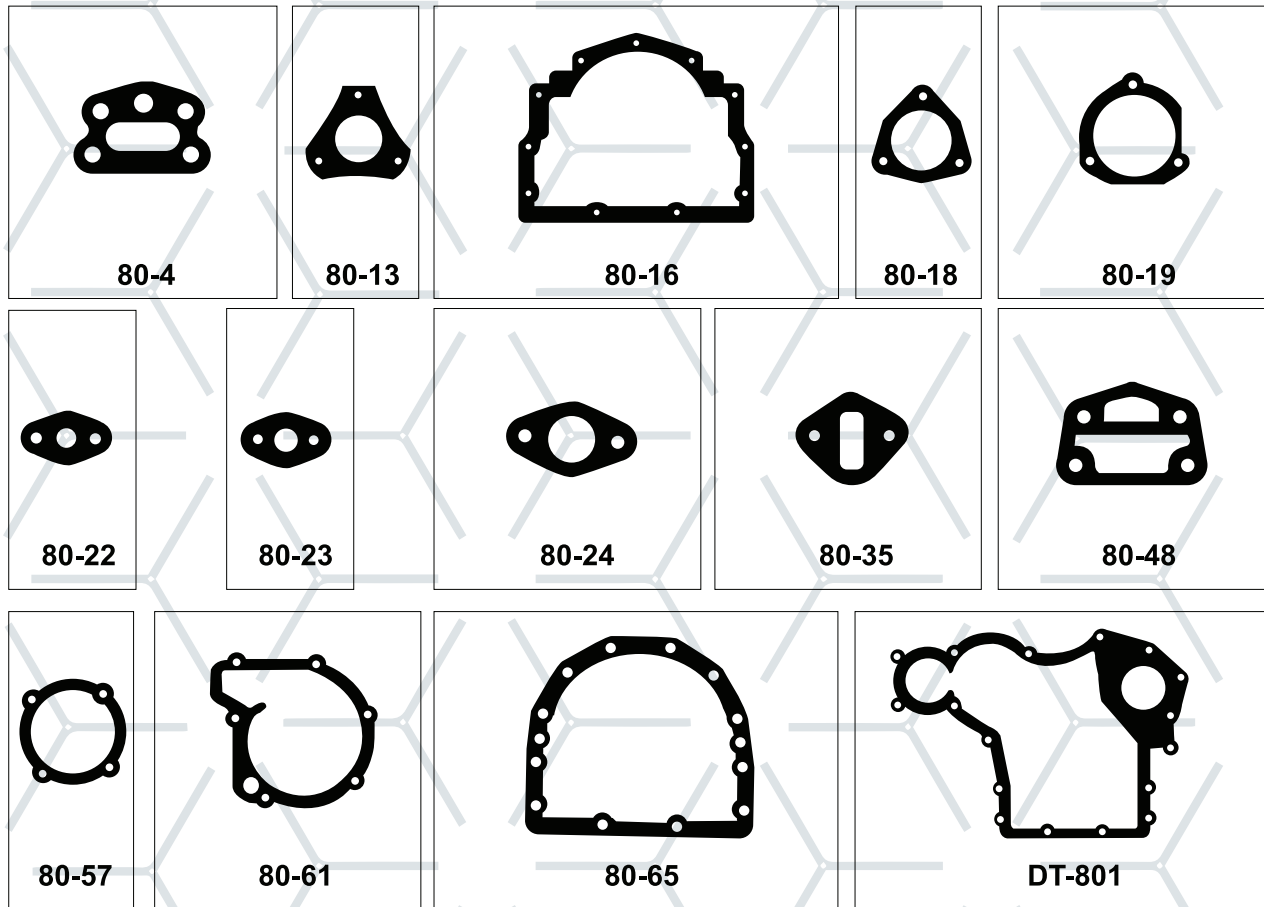

PERKINS	FIRTS	APLICACIÓN
354-2-6	80-4	Junta Adaptador al Monoblock
33828108	80-13	Junta Adaptador a Bomba de Combustible
36817136	80-16	Junta Tapa Trasera Cigüeñal
36822111	80-18	Junta Brida Tubo Escape
36822118	80-19	Junta Adaptador de Bomba Inyección
36831114	80-22	Junta Válvula de Aceite
36831115	80-23	Junta para Tubo Llenado de Aceite
36832118	80-24	Junta Base Bomba de Aceite
36862126	80-35	Junta Bomba de Combustible
36862538	80-48	Junta Filtro de Aceite
36866434	80-57	Junta para Caja de Inspección
36867108	80-61	Junta Bomba a Monoblock
36817157	80-65	Junta Tapa Trasera Cigüeñal
36814124	DT-801	Junta Tapa de Distribución

MOTOR 6-354 FASE IV

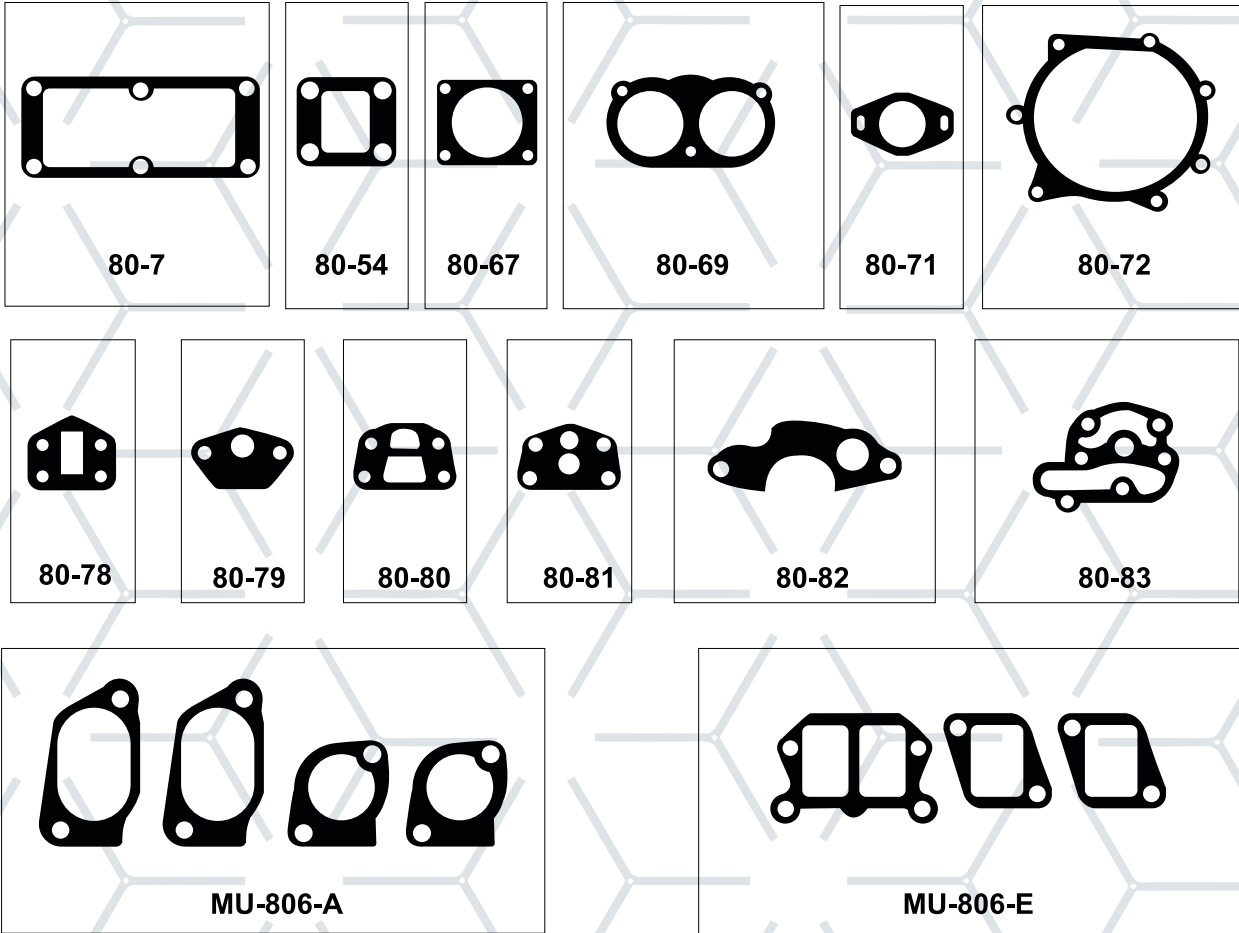

PERKINS	FIRTS	APLICACIÓN
490485	80-7	Junta Tapa Trasera de Cabeza
36866423	80-54	Junta Bomba de Vacío
36823132	80-67	Junta Conexión Salida de Agua
36861745	80-69	Junta Tapa Múltiple de Admisión
36834143	80-71	Junta Bomba de Inyección a Plato
36867173	80-72	Junta Bomba de Agua a Plato
36856102	80-78	Junta Bomba Elevadora de Combustible
36861448	80-79	Junta Adaptador a Block
36862559	80-80	Junta Soporte Enfriador
36862561	80-81	Junta Enfriador de Aceite
36865532	80-82	Junta Bomba de Aceite
36865533	80-83	Junta Adaptador Filtro de Aceite
	MU-806-A	Juego de Juntas Múltiple de Admisión
	MU-806-E	Juego de Juntas Múltiple de Escape

MOTOR 6-354 FASE IV

PERKINS

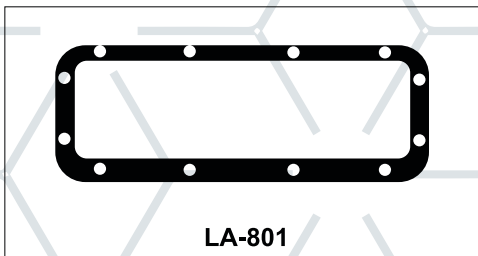
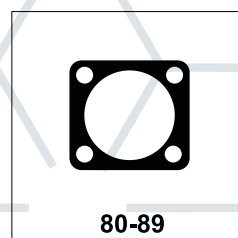
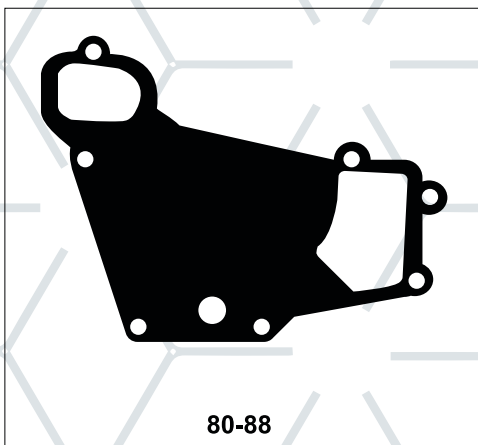
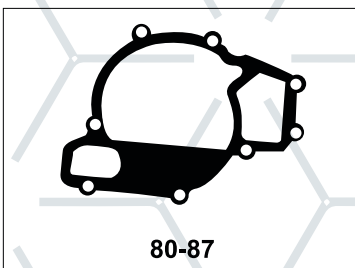
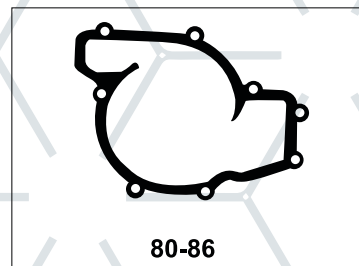
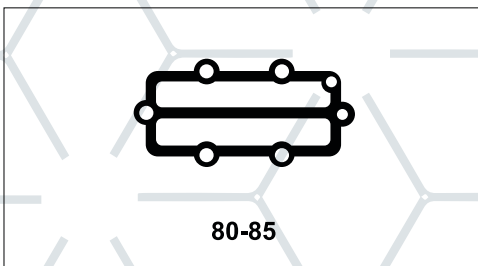
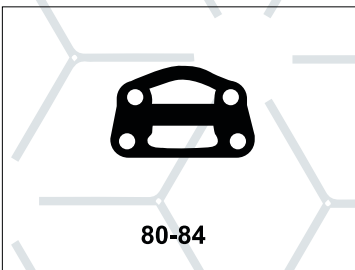

ORIGINAL	FIRTS	APLICACIÓN
36866105	80-84	Junta Enfriador de Aceite
36866747	80-85	Junta Cabeza Filtro de Aceite
36867162	80-86	Junta a Block a Bomba de Agua
36867165	80-87	Junta Block Bomba de Agua
36867174	80-88	Junta Entrada a Bomba de Agua
490007	80-89	Junta Cuerpo Alimentador de Aceite
36846408	LA-801	Junta Tapa Lateral

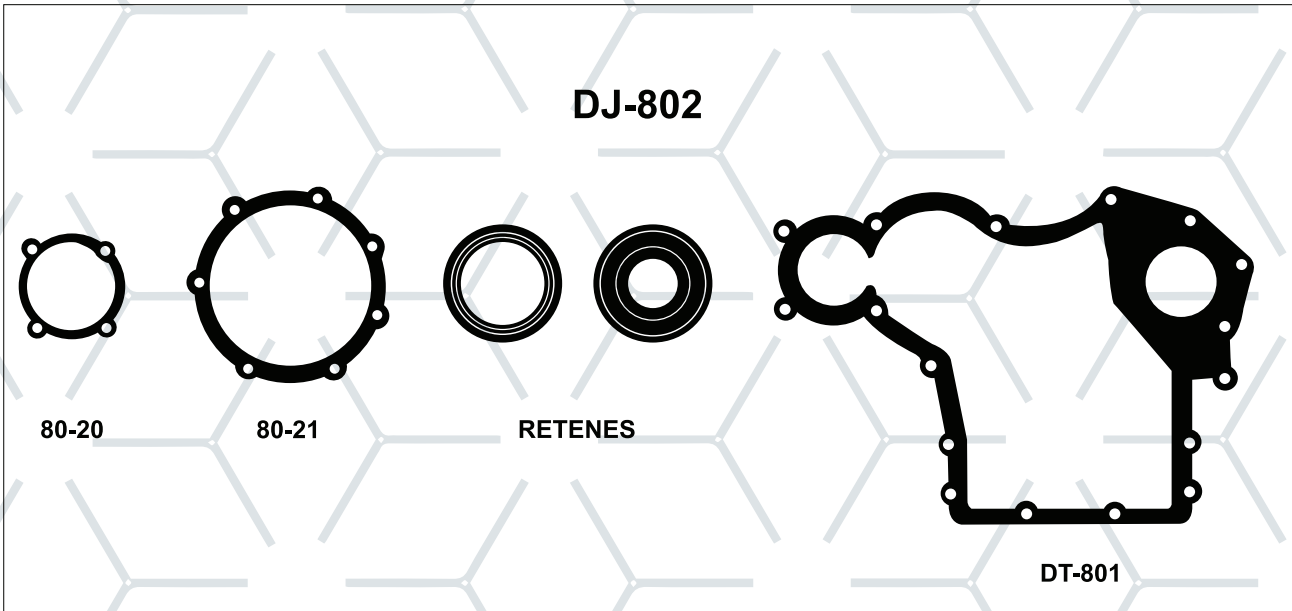

JUEGO DE JUNTAS DISTRIBUCIÓN INCLUYE 80-20, 80-21, DT-801 Y RETENES

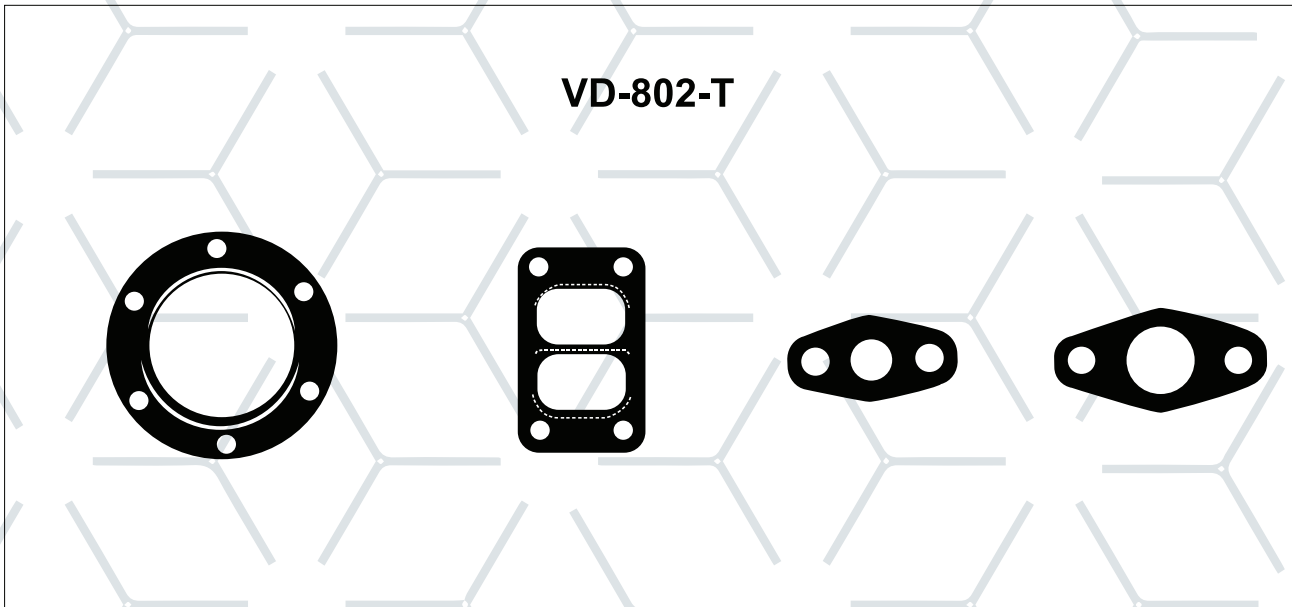

JUEGO DE JUNTAS TURBO CARGADOR PERKINS FASE II Y IV

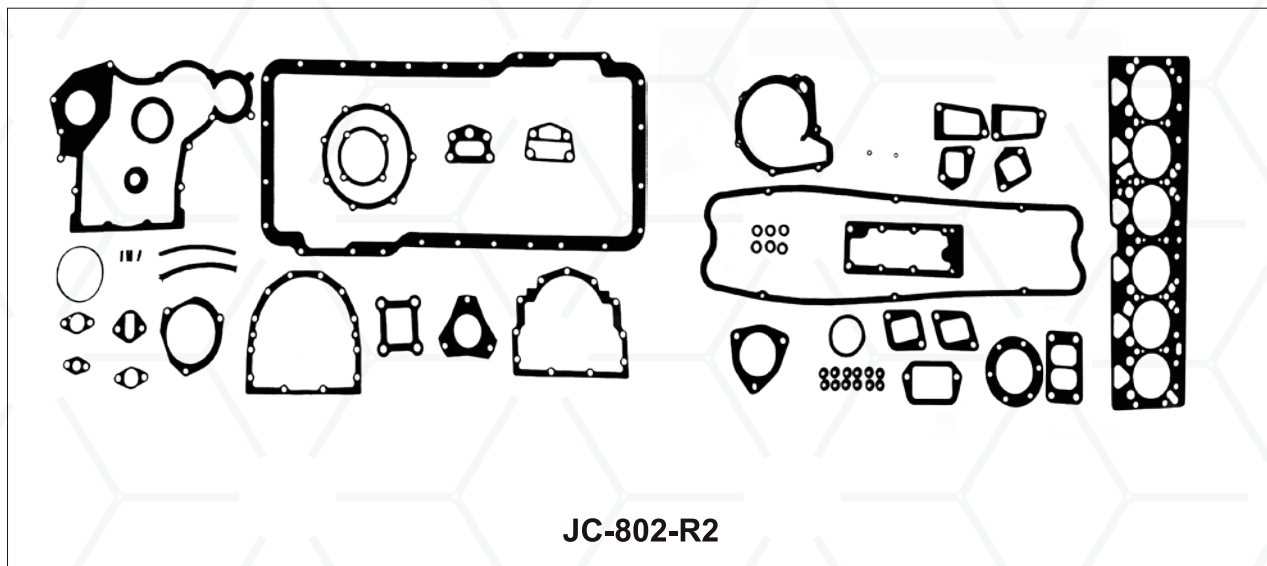
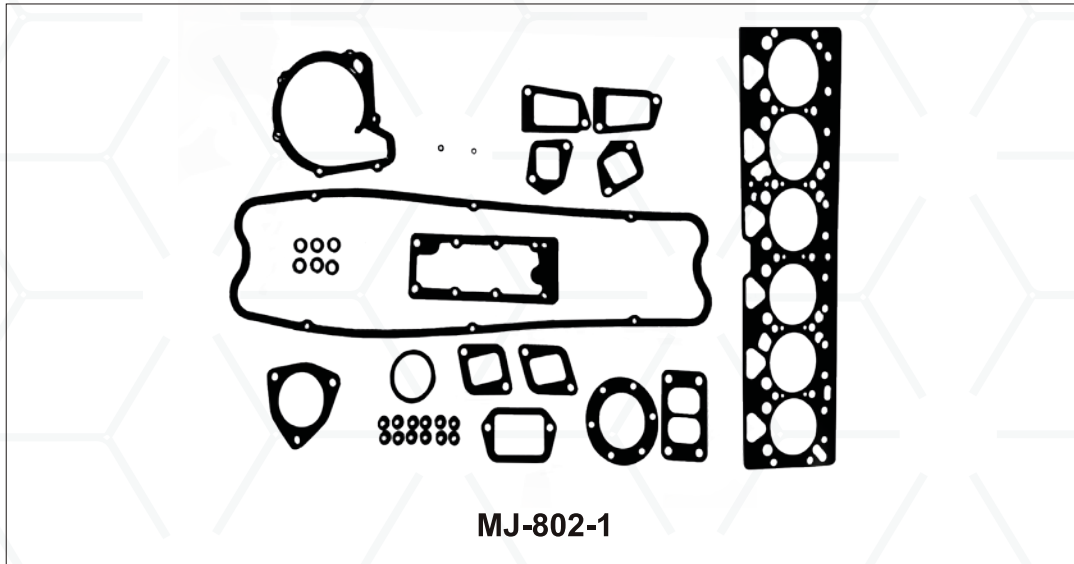

ORIGINAL	FIRTS	APLICACIÓN
	MJ-802-1	Medio Juego Superior PERKINS FASE II
	JC-802-R2	Juego Completo PERKINS FASE II CON RETENES

EMPAQUES AUTOMOTRICES FIRTS

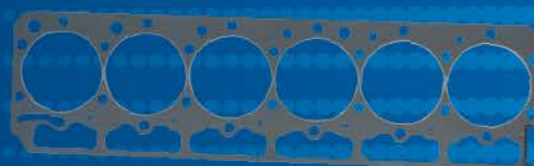
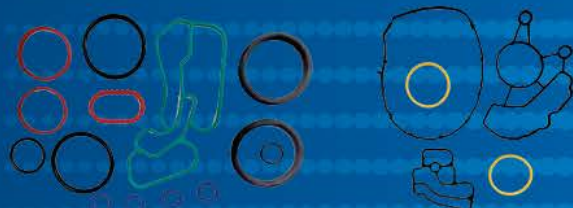
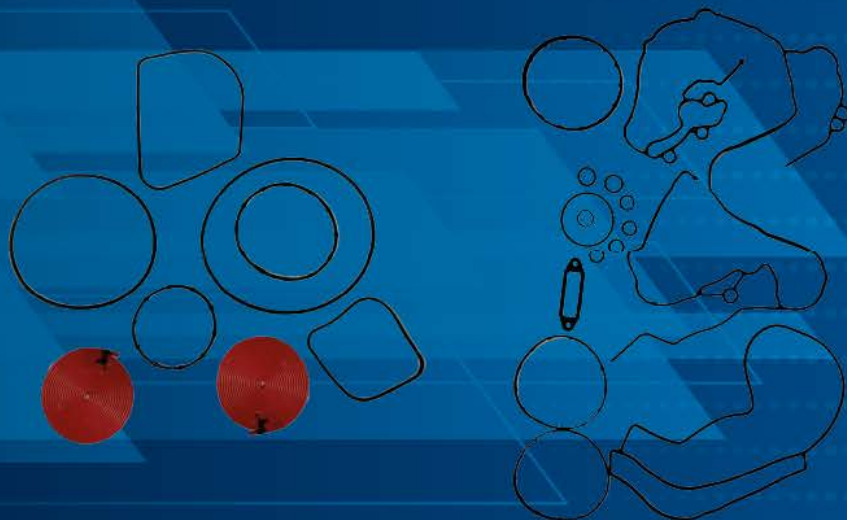

CONTÁCTANOS

ventas.firts@gmail.com
contacto@firtsdiesel.com

☎ 01 779 796 3721

☎ 01 779 796 7333



www.firtsdiesel.com