

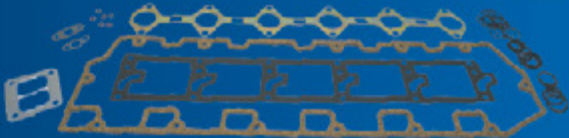

# CATÁLOGO DIESEL

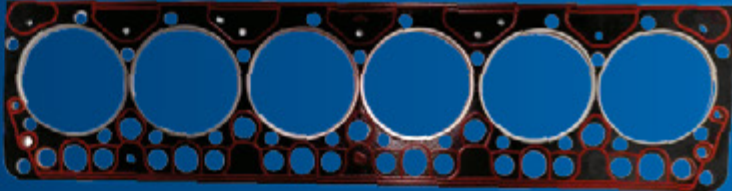

**EMPAQUES Y JUNTAS  
PARA PROFESIONALES**

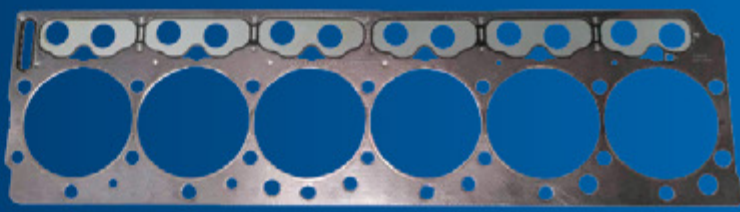
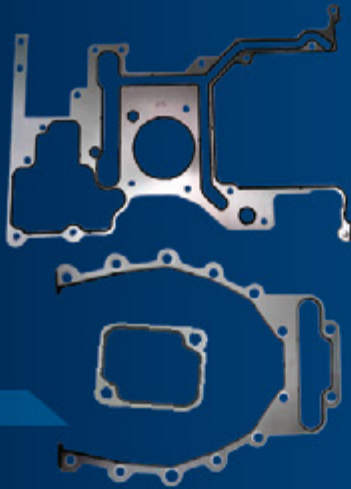
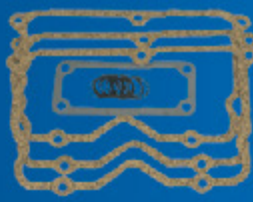





## AGRADECIMIENTOS

**FIRTS DIESEL GASKETS** es una empresa que mantiene altos estándares de calidad y servicio, gracias al apoyo de todos nuestros colaboradores que con su esfuerzo y empeño diario durante estos 15 años, han demostrado dedicación en fabricar los mejores productos y brindar el mejor servicio del mercado.

Asimismo, agradecemos a nuestros proveedores que son socios estratégicos en el funcionamiento de nuestra empresa, cumpliendo con tiempos de entrega y calidad en los materiales.

Finalmente, el éxito alcanzado se lo debemos a ustedes estimados clientes por depositar su confianza en nosotros, gracias por su preferencia durante esta gran trayectoria.





## ÍNDICE

<b>NOMENCLATURA</b> .....	<b>7</b>
<b>PERKINS</b> .....	<b>9</b>
Motor 6-354 Fase II .....	11
Motor 6-354 Fase IV.....	13
<b>DINA CUMMINS</b> .....	<b>17</b>
V-6 (140-155) y V-8 (185-210).....	19
<b>CUMMINS</b> .....	<b>29</b>
335-350 BIG CAM I, II, III, IV y 400 .....	31
N-14 Automotive y Command .....	45
L-10, M11, 156, Serie B.....	60
ISX .....	66
<b>NAVISTAR</b> .....	<b>75</b>
DT 466 .....	77
NAVISTAR MAX FORCE NGD 408, 466 y 530 Mecánicos y Electrónicos .....	84
<b>MERCEDES BENZ</b> .....	<b>95</b>
OM-366 .....	99
OM-904 .....	104
OM-906, 924, 926 .....	105
<b>DETROIT</b> .....	<b>109</b>
S-60 .....	113
<b>CATERPILLAR</b> .....	<b>125</b>
3116 y 3126.....	127
<b>SELLOS DE VÁLVULA</b> .....	<b>133</b>
<b>TRANSMISIONES</b> .....	<b>137</b>
<b>DIFERENCIALES</b> .....	<b>147</b>
<b>COMPRESORES</b> .....	<b>133</b>
<b>FLECHAS LATERALES</b> .....	<b>143</b>



## ÍNDICE VARIOS DIESEL

N° PARTE	APLICACIÓN	PÁGINA
ALAR51477	CUMMINS	LIGA DE CAMISA ..... 49
VD-001	COMPRESOR	TU-FLO 400..... 135
VD-002	COMPRESOR	TU-FLO 500..... 135
VD-009	COMPRESOR	TU-FLO 501..... 135
VD-012	DINA CUMMINS	COMPRESOR ..... 27
VD-012-3	DINA CUMMINS	COMPRESOR ..... 27
VD-012-350	CUMMINS	COMPRESOR ..... 50
VD-012-4	DINA CUMMINS	COMPRESOR ..... 28
VD-014	DINA CUMMINS	ENFRIADOR DE ACEITE ..... 28
VD-015	CUMMINS	ENFRIADOR DE ACEITE ..... 50
VD-015-N14	CUMMINS N14	ENFRIADOR DE ACEITE ..... 51
COM-VD-016-LA	CUMMINS	FRENO DE MOTOR..... 52
VD-016	CUMMINS	FRENO DE MOTOR..... 52
VD-016-400	CUMMINS	FRENO DE MOTOR..... 53
VD-016-BC4	CUMMINS	FRENO DE MOTOR..... 53
VD-016-LA	CUMMINS	FRENO DE MOTOR..... 51
VD-016-N14	CUMMINS	FRENO DE MOTOR..... 54
VD-017	CUMMINS	ENFRIADOR DE ACEITE ..... 54
VD-021	CUMMINS	INTERCOOLER ..... 55
VD-054	CUMMINS	BOMBA DE ACEITE ..... 55
VD-054-XAL	CUMMINS	BOMBA DE ACEITE ..... 56
VD-055	COMPRESOR	MIDLAND 2"..... 137
VD-056	COMPRESOR	MIDLAND 2-3/4"..... 137
VD-057	COMPRESOR	WABCO ..... 138
VD-058	COMPRESOR	KNORR ..... 138
VD-059	COMPRESOR	BENDIX ..... 138
VD-060	COMPRESOR	KNORR ..... 138
VD 061	COMPRESOR	WABCO ..... 139
VD-062	COMPRESOR	WABCO ..... 139
VD-063	CUMMINS	BOMBA DE AGUA ..... 56
VD-063-N14	CUMMINS	BOMBA DE AGUA ..... 57
VD-063-N14E	CUMMINS	BOMBA DE AGUA ..... 57

## ÍNDICE VARIOS DIESEL

Nº PARTE	APLICACIÓN	PÁGINA
VD-064	COMPRESOR BENDIX.....	140
VD-065	NAVISTAR DISTRIBUCIÓN.....	77
VD-066	NAVISTAR TURBO .....	77
VD-067	NAVISTAR ENFRIADOR DE ACEITE .....	78
VD-068	NAVISTAR DISTRIBUCIÓN.....	78
VD-069	NAVISTAR INYECTORES .....	79
VD-069-1	NAVISTAR INYECTORES .....	79
VD-070	NAVISTAR ENFRIADOR DE ACEITE .....	89
VD-071	MERCEDES DISTRIBUCIÓN.....	89
VD-072	DETROIT ÁRBOL DE LEVAS .....	102
VD-073	DETROIT ENFRIADOR DE ACEITE .....	102
VD-074	DETROIT INYECTORES .....	103
VD-075	MERCEDES BOMBA DE AGUA.....	89
VD-078	MERCEDES BENZ TURBO MERCEDES BENZ 904-906 GRAFITO.....	90
VD-079	COMPRESOR ELECTRÓNICO N14.....	141
VD-080	COMPRESOR WABCO DOBLE PISTÓN PARA VOLVO.....	141
VD-081	COMPRESOR YORK .....	141
VD-082	COMPRESOR BRASILEÑA.....	141
VD-083	COMPRESOR WABCO-KNORR.....	141
VD-084	COMPRESOR MULT-60 CABEZA VOLADA (412352005) .....	141
VD-085	COMPRESOR WABCO DOBLE PISTÓN PARA MERCEDES BENZ .....	141
VD-086	COMPRESOR VOLADA WABCO .....	141
VD-087	COMPRESOR BENDIX DOBLE PISTÓN .....	141
VD-088	COMPRESOR WABCO DOBLE PISTÓN MERCEDEZ BENZ .....	142
VD-089	COMPRESOR WABCO DOBLE PISTÓN VOLVO .....	142
VD-090	COMPRESOR WABCO DOBLE PISTÓN ENFRIADO POR AGUA .....	142
VD-091	CUMMINS ISX ÁRBOL DE LEVAS ISX Y LIGAS DIESEL.....	63
VD-091-2	CUMMINS ISX ÁRBOL DE LEVAS Y DISTRIBUCIÓN ISX.....	163
VD-092-1	CUMMINS ISX INYECTOR ISX.....	163
VD-092-6	CUMMINS ISX 6 INYECTORES ISX.....	63
VD-802-T	PERKINS TURBOCARGADOR .....	15
VD-L210	DINA CUMMINS CAMISA .....	26
VDL600	DETROIT CAMISA .....	103



## ÍNDICE VARIOS DIESEL

Nº PARTE	APLICACIÓN	PÁGINA
VD-LA-904	CUMMINS	AJUSTE MOTOR SMALL CAMM..... 59
VD-LA-905	CUMMINS	AJUSTE MOTOR BIG CAMM..... 59
CJ-600-T	DETROIT	JUEGO PARA CÁRTER ..... 101
CJ-KIT-904	CUMMINS	JUEGO PARA CÁRTER ..... 49
CJ-KIT-L10-32	CUMMINS L10	JUEGO PARA CÁRTER ..... 61
CJ-KIT-L10-34	CUMMINS L10	JUEGO PARA CÁRTER ..... 61
DJ-802	PERKINS	JUEGO DISTRIBUCIÓN ..... 15
PS-600-T	DETROIT	JUEGO PARA PUNTERÍAS ..... 100
TCJ-600	DETROIT	JUEGO SOPORTES PARA CÁRTER ..... 101
TPS-600	DETROIT	JUEGO SOPORTES PARA PUNTERÍAS..... 100

MOTOR	CLAVE PIEZA	CLAVE JUEGO
PERKINS	80	801, 802
DINA CUMMINS V6	90	901
DINA CUMMINS V8	90	902
CUMMINS 350 BIG CAM I. II. III, IV y 400	94	904
CUMMINS N-14	97	907
CUMMINS L-10	L10	L10
CUMMINS ISX	ISX	ISX
NAVISTAR DT-466	214	2104
NAVISTAR DT-360	214	2105
NAVISTAR NGD	216	2106
MERCEDES BENZ	366	366
MERCEDES BENZ MB-904	MB	MB-904-1
MERCEDES BENZ MB-906	MB	MB-906-1
DETROIT S-60	60	600
CATERPILLAR	3126	3126

APLICACIÓN	PREFIJOS			SUFIJOS
	FIRTS	ATLAS	TF VICTOR	
JUEGO COMPLETO	JC	J	JC	
MEDIO JUEGO	MJ	K	MJ	1=SUPERIOR 2=INFERIOR
TERCIOS O CUARTOS DE JUEGO	KJ	KM	MJ	
ESCAPE	ES	E	ES	T=TURBO
JUNTA CÁRTER	CJ	C	CJ	2=UNITARIA
JUNTA DE PUNTERÍAS	PS	P	PS	
JUNTA DE CABEZA	CA	H	CA	
JUNTA DE MÚLTIPLE	MU	M	MU	A=ADMISIÓN E=ESCAPE
LATERALES	LA	L	VD	
DISTRIBUCIÓN	DT	D	DT	
DIFERENCIALES	DF	DIF	DF	
TRANSMISIONES	TS	TD	TS	
VARIOS DIESEL	VD	VA	VD	





## PERKINS

<b>PIEZAS SUELTAS .....</b>	<b>11</b>
<b>VARIOS DIESEL .....</b>	<b>15</b>
<b>DJ-802</b>	<b>Juegos de Juntas para Distribución</b>
<b>VD-802-T</b>	<b>Juego de Juntas Turbo Cargador</b>



**MOTOR 6-354 FASE II**

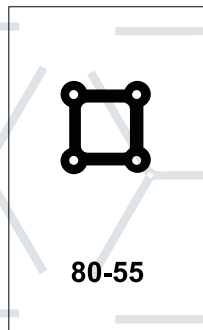
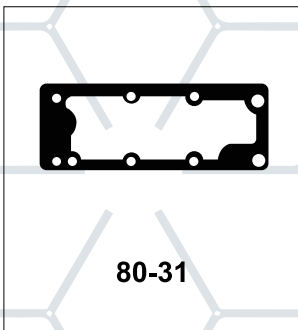
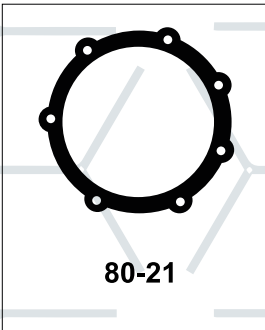
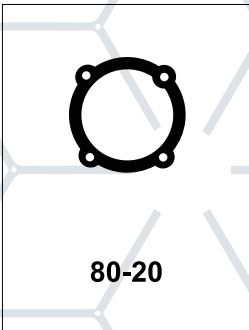
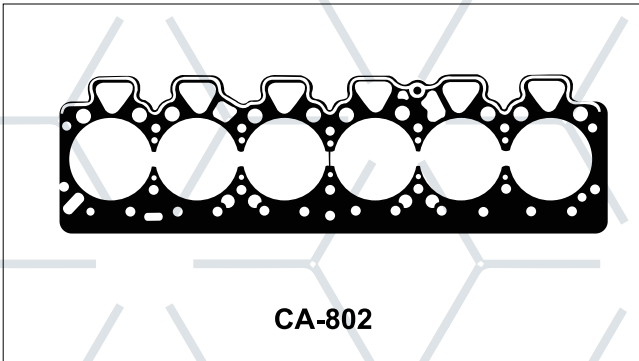
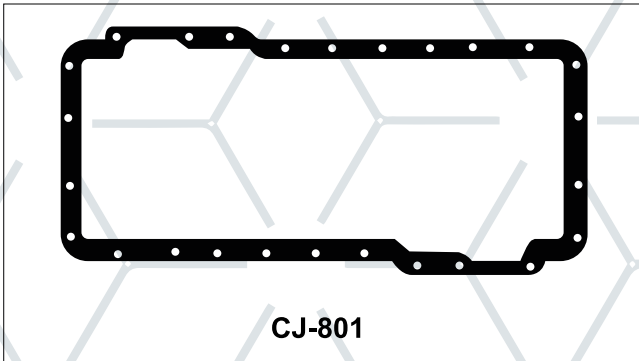
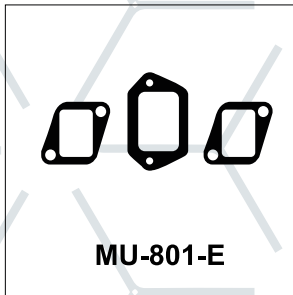
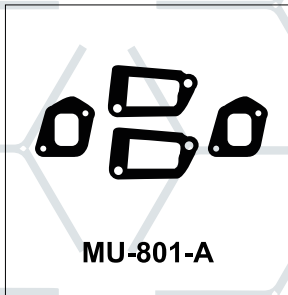
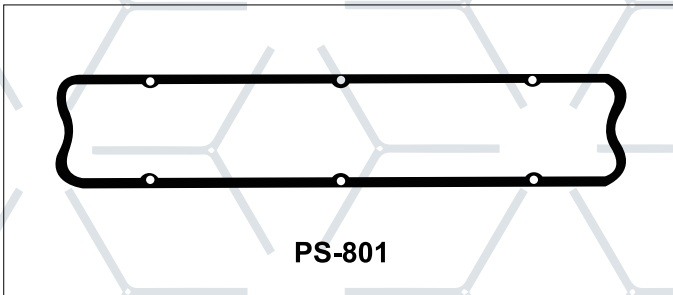

PERKINS

ORIGINAL	FIRTS	APLICACIÓN
36811427	PS-801	Junta Tapa Puntería
36816702	CJ-801	Junta para Cáster
	MU-801-A	Juego de Juntas Múltiple de Admisión
36862129	MU-801-E	Juego de Juntas Múltiple Escape
36862124		
	CA-802	Junta de Cabeza Perkins Fase II
36825107	80-20	Junta Tapa Adaptador Tacómetro
36826107	80-21	Junta Tapa de Engrane Árbol de Levas
3684-R003	80-31	Junta Cuerpo Salida de Agua
36866426	80-55	Junta Soporte Compresor

**MOTOR 6-354 FASE II**

PERKINS

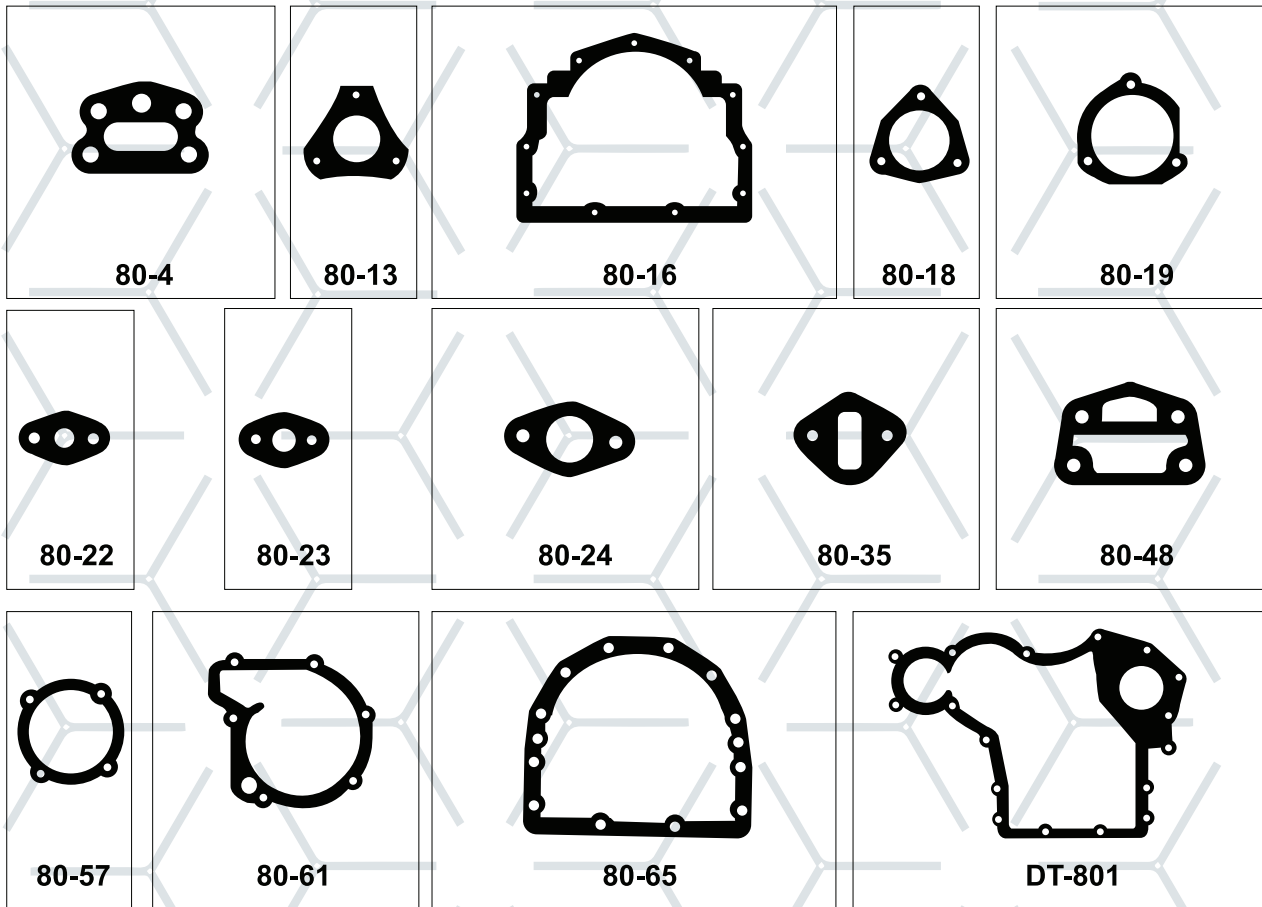

PERKINS	FIRTS	APLICACIÓN
354-2-6	80-4	Junta Adaptador al Monoblock
33828108	80-13	Junta Adaptador a Bomba de Combustible
36817136	80-16	Junta Tapa Trasera Cigüeñal
36822111	80-18	Junta Brida Tubo Escape
36822118	80-19	Junta Adaptador de Bomba Inyección
36831114	80-22	Junta Válvula de Aceite
36831115	80-23	Junta para Tubo Llenado de Aceite
36832118	80-24	Junta Base Bomba de Aceite
36862126	80-35	Junta Bomba de Combustible
36862538	80-48	Junta Filtro de Aceite
36866434	80-57	Junta para Caja de Inspección
36867108	80-61	Junta Bomba a Monoblock
36817157	80-65	Junta Tapa Trasera Cigüeñal
36814124	DT-801	Junta Tapa de Distribución

**MOTOR 6-354 FASE IV**

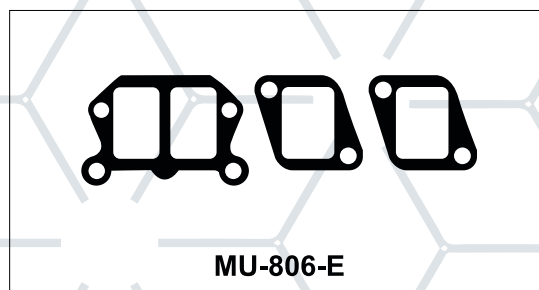
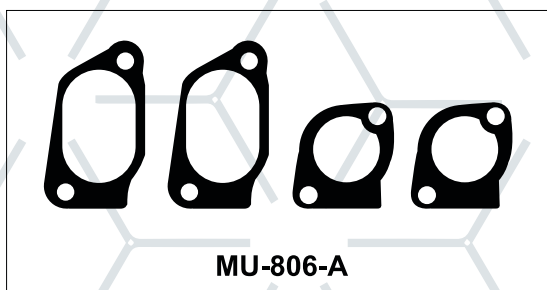
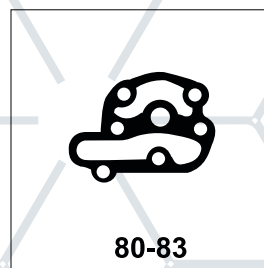
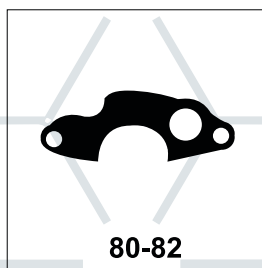
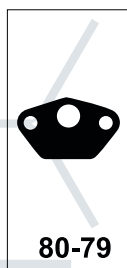
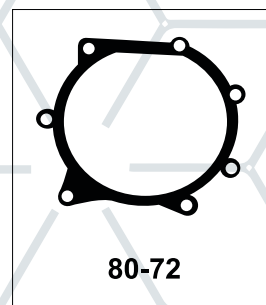
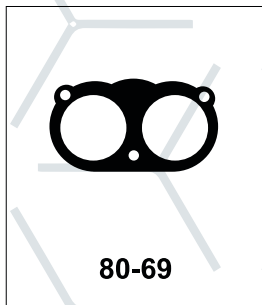
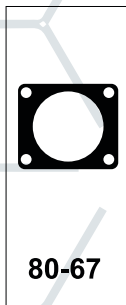
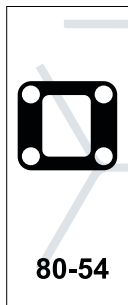
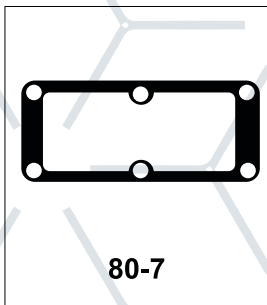

PERKINS

PERKINS	FIRTS	APLICACIÓN
490485	80-7	Junta Tapa Trasera de Cabeza
36866423	80-54	Junta Bomba de Vacío
36823132	80-67	Junta Conexión Salida de Agua
36861745	80-69	Junta Tapa Múltiple de Admisión
36834143	80-71	Junta Bomba de Inyección a Plato
36867173	80-72	Junta Bomba de Agua a Plato
36856102	80-78	Junta Bomba Elevadora de Combustible
36861448	80-79	Junta Adaptador a Block
36862559	80-80	Junta Soporte Enfriador
36862561	80-81	Junta Enfriador de Aceite
36865532	80-82	Junta Bomba de Aceite
36865533	80-83	Junta Adaptador Filtro de Aceite
	MU-806-A	Juego de Juntas Múltiple de Admisión
	MU-806-E	Juego de Juntas Múltiple de Escape

**MOTOR 6-354 FASE IV**

PERKINS

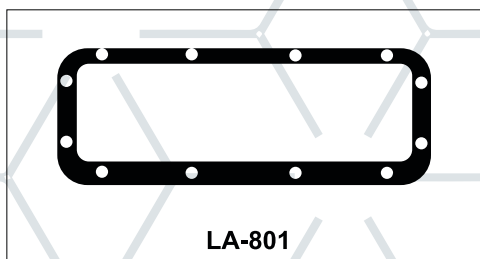
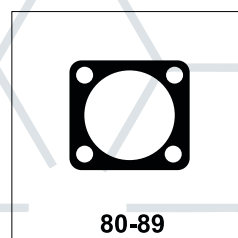
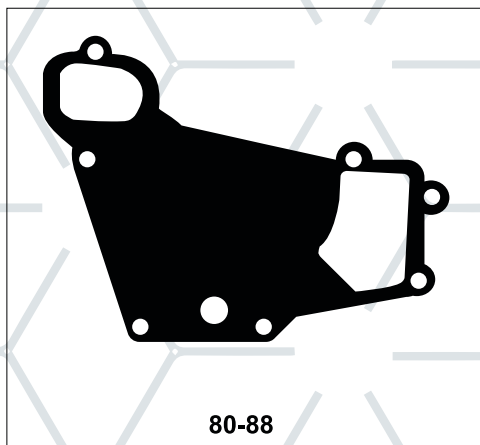
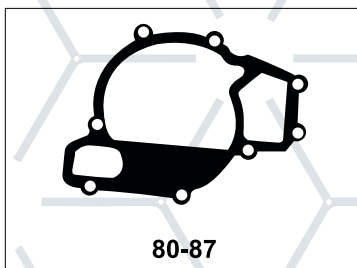
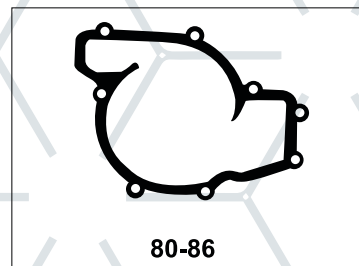
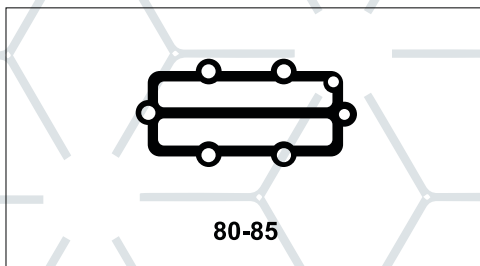
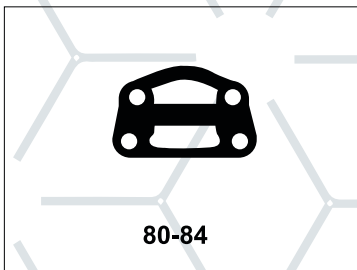

ORIGINAL	FIRTS	APLICACIÓN
36866105	80-84	Junta Enfriador de Aceite
36866747	80-85	Junta Cabeza Filtro de Aceite
36867162	80-86	Junta a Block a Bomba de Agua
36867165	80-87	Junta Block Bomba de Agua
36867174	80-88	Junta Entrada a Bomba de Agua
490007	80-89	Junta Cuerpo Alimentador de Aceite
36846408	LA-801	Junta Tapa Lateral

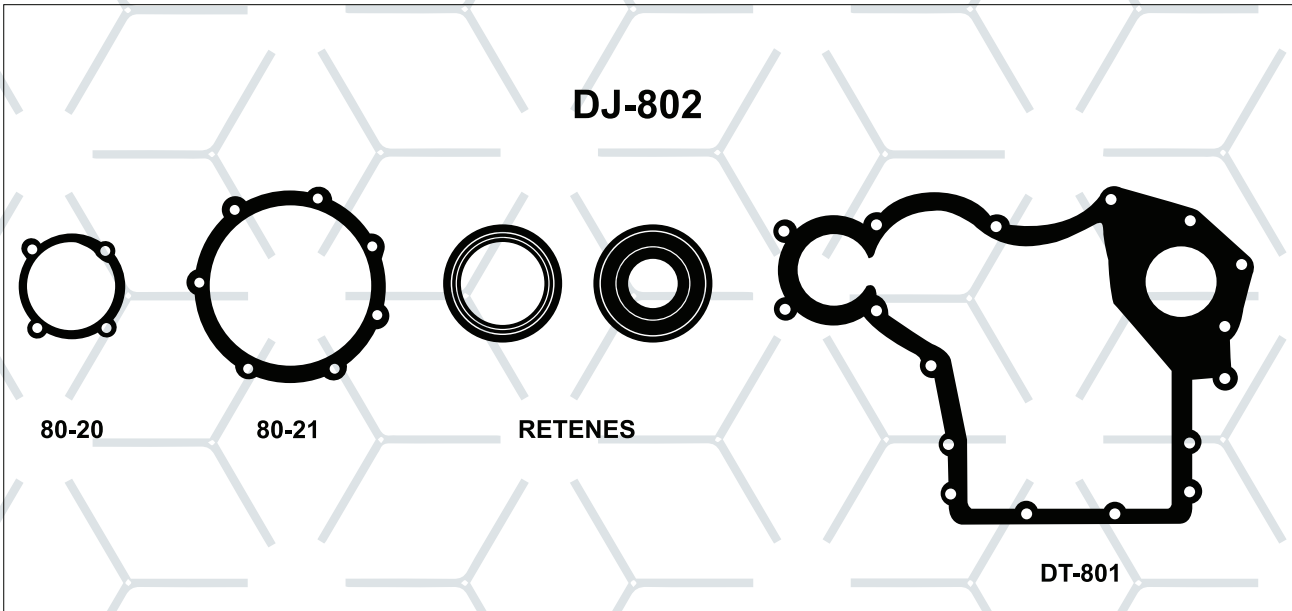

JUEGO DE JUNTAS DISTRIBUCIÓN INCLUYE 80-20, 80-21, DT-801 Y RETENES

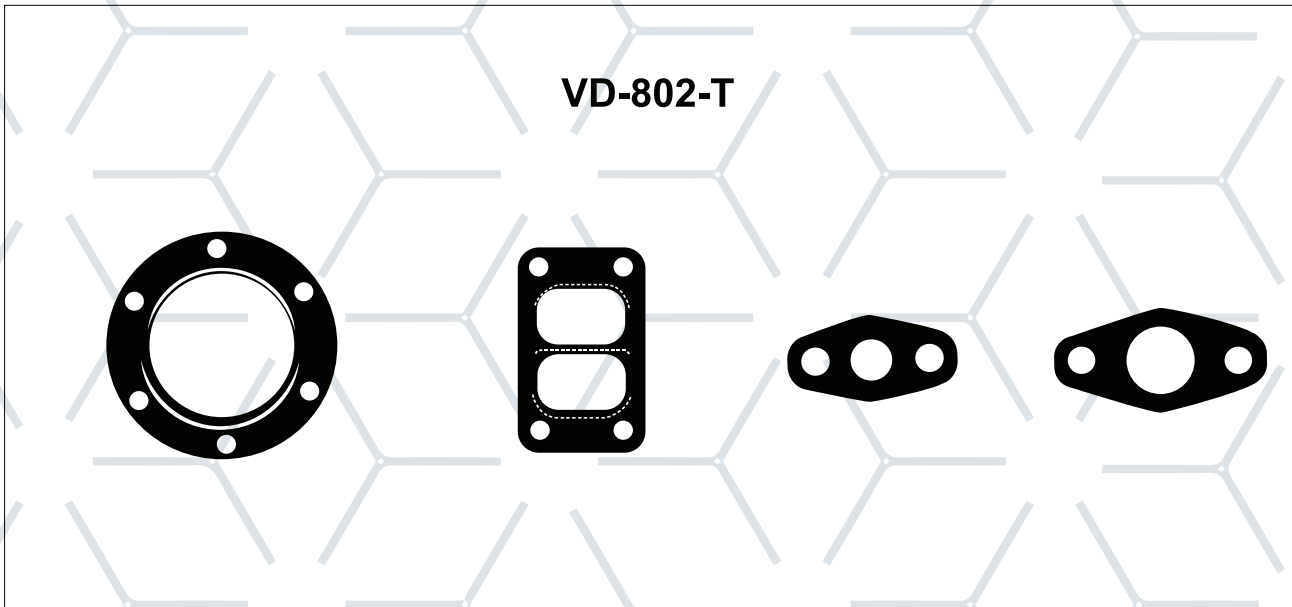

JUEGO DE JUNTAS TURBO CARGADOR PERKINS FASE II Y IV

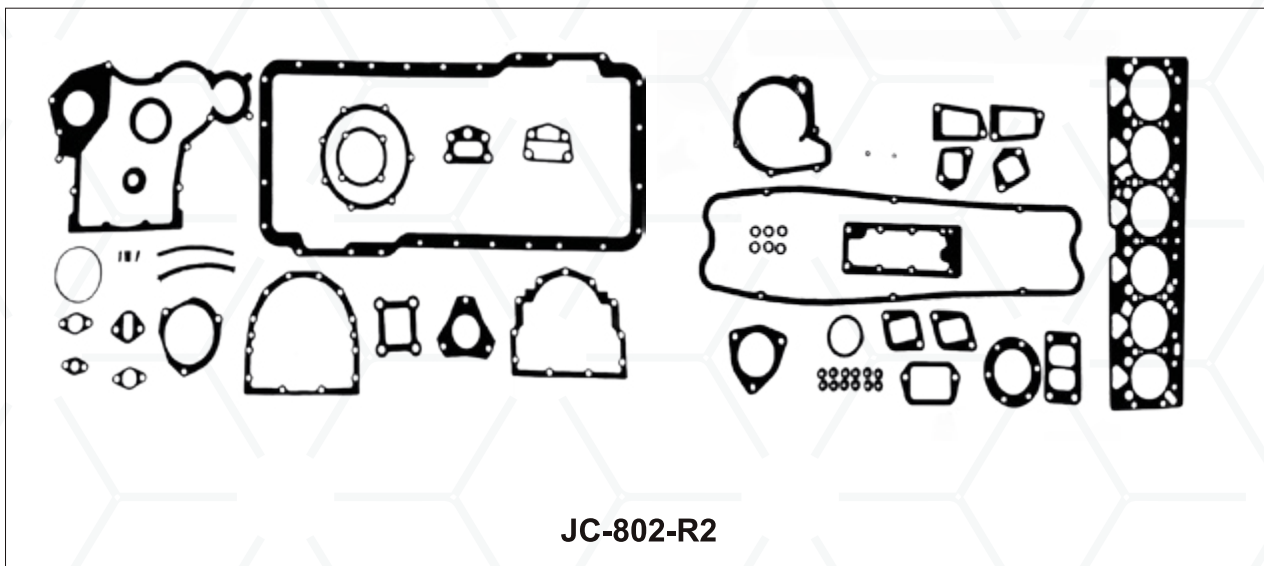
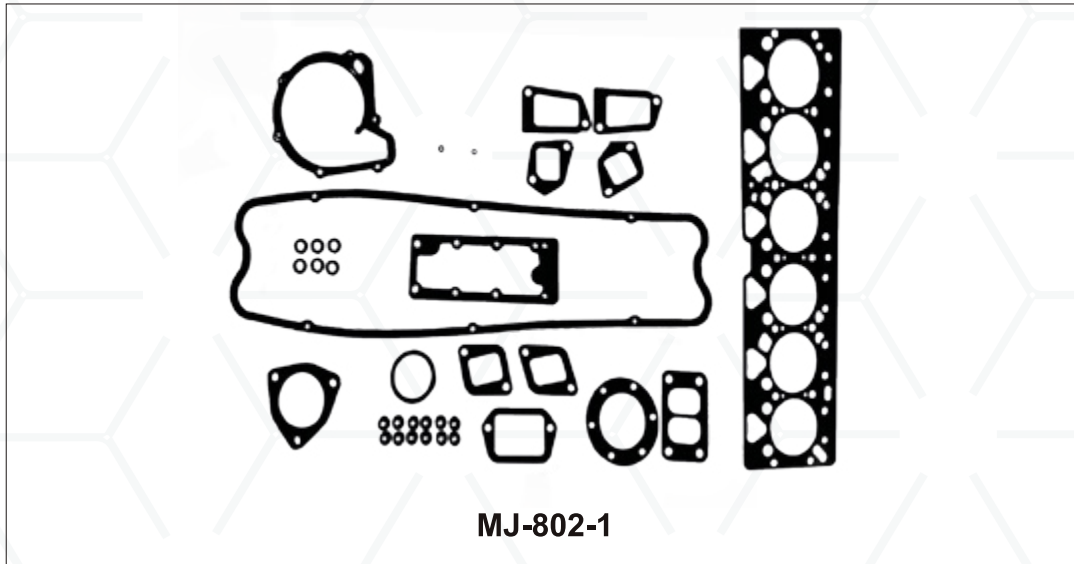

ORIGINAL	FIRTS	APLICACIÓN
	MJ-802-1	Medio Juego Superior PERKINS FASE II
	JC-802-R2	Juego Completo PERKINS FASE II CON RETENES



## DINA-CUMMINS V6-V8

<b>JUEGO DE JUNTAS .....</b>	<b>19</b>
<b>PIEZAS SUELTAS .....</b>	<b>22</b>
<b>VARIOS DIESEL .....</b>	<b>26</b>
<b>VD-L210</b>	<b>Juegos de Ligas para Camisa</b>
<b>VD-012</b>	<b>Juego de Juntas para Compresor</b>
<b>VD-012-3</b>	<b>Juego de Juntas para Compresor</b>
<b>VD-012-4</b>	<b>Juego de Juntas para Compresor</b>
<b>VD-014</b>	<b>Juego de Juntas para Enfriador de Aceite</b>





**MOTORES V6 140-155 HP  
y V8 185-210 HP**

CUMMINS	FIRTS	APLICACIÓN
	JC-901	Juego Completo de Juntas para Motor V6 140-155 HP
3277752		
AR-63506	MJ-901-1	Juego de Juntas Superior Motor V6 140-155 HP
38218-05		
3277744		
AR-63509	MJ-901-2	Juego de Juntas Inferior Motor V6 140-155 HP
73414-05		
	KJ-901	Juego de Juntas para Una Cabeza Motor V6 140-155 HP

DINA-CUMMINS

CUMMINS	FIRTS	APLICACIÓN
	JC-902	Juego Completo de Juntas para Motor V8 185-210 HP
3277753		
AR-63500	MJ-902-1	Juego de Juntas Superior Motor V8 185-210 HP
72414-05		
3277549		
AR-63505	MJ-902-2	Juego de Juntas Inferior Motor V8 185-210 HP
32414-05		
	KJ-902	Juego de Juntas para Una Cabeza Motor V8 185-210 HP

JC-901 ( JUEGO COMPLETO V6= MJ-901-1 + MJ-901-2 )

JC-902 ( JUEGO COMPLETO V8= MJ-902-1 + MJ-902-2 )

**CONTENIDO**
**DINA-CUMMINS**
**MJ-901-1  
AL3277752 / Juego Superior V6**

Cummins	Firts	Cantidad MJ-901	Cantidad KJ-901
168069	90-15	2	1
	90-22	1	1
9221	90-35	1	1
157290	90-41	4	2
553916	90-42	1	1
555959	90-43	2	1
556711	SEG. 1	4	2
551108	SEG. 2	4	2
154415	MU-901-A	2	1
556356	MU-901-EJ	2	1
154019	PS-901	2	1
156541	SV-901	12	6
31063	O'RING	4	2
101754	O'RING	18	9
555198	O'RING	4	2
556371	CORCHO	4	2
	CA-901	2	1

**MJ-901-2  
AL3277744 / Juego Inferior V6**

Cummins	Firts	Cantidad
167802	90-2	1
3277379	90-3	1
168650	90-4	1
167778	90-8	1
157911	90-11	1
153433	90-13	1
167993	90-14	1
169042	90-16	1
164059	90-17	1
154018	90-18	1
3005592	90-23	1
176597	90-25	1
164916	90-27	1
176027	90-29	1
176924	90-31	1
165153	90-32	1
166407	90-33	1
188396	90-36	1
550164	90-37	1
178283	90-38	1
156826	90-39	1
175726	CJ-901	1

**CONTENIDO**

<b>MJ-902-1</b>			
<b>AL3277753 / Juego Superior V8</b>			
<b>Cummins</b>	<b>Firts</b>	<b>Cantidad MJ-902</b>	<b>Cantidad KJ-902</b>
168069	90-15	2	1
	90-22	1	1
9221	90-35	1	1
157290	90-41	4	2
553916	90-42	1	1
555960	90-44	2	1
556711	SEG. 1	4	2
551108	SEG. 2	6	3
156996	MU-902-A	2	1
556355	MU-902-EJ	2	1
3277099	PS-902	2	1
156541	SV-901	16	8
31063	O'RING	4	2
101754	O'RING	24	12
555198	O'RING	4	2
556371	CORCHO	4	2
	CA-902	2	1

<b>MJ-902-2</b>		
<b>AL3277549 / Juego Inferior V8</b>		
<b>Cummins</b>	<b>Firts</b>	<b>Cantidad</b>
167802	90-2	1
3277379	90-3	1
168650	90-4	1
157911	90-11	1
153433	90-13	1
167993	90-14	1
169042	90-16	1
164059	90-17	1
154018	90-18	1
3005592	90-23	1
164916	90-27	1
176027	90-29	1
167800	90-30	1
176924	90-31	1
165153	90-32	1
166407	90-33	1
188396	90-36	1
550164	90-37	1
178283	90-38	1
156826	90-39	1
552129	90-40	1
175727	CJ-902	1

**DINA-CUMMINS**

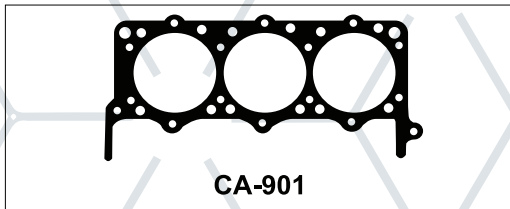
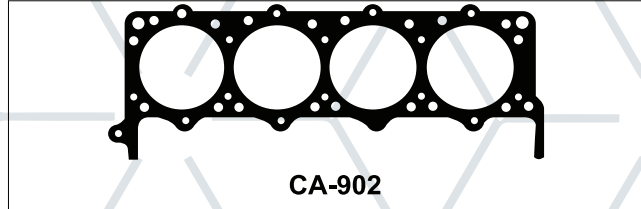
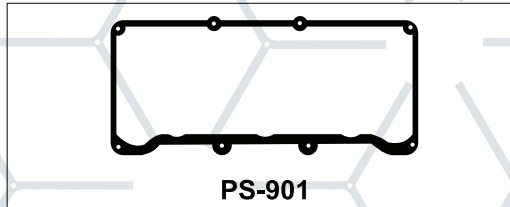
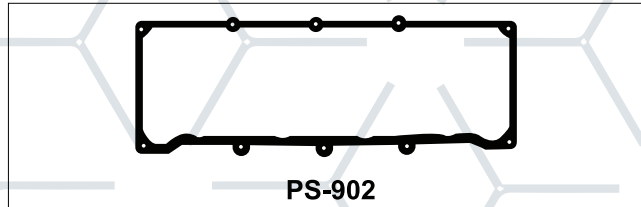
**MOTORES V6 140-155 HP  
Y V8 185-210 HP**

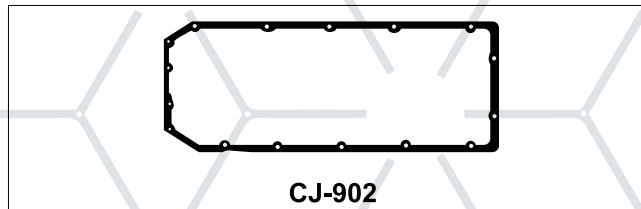
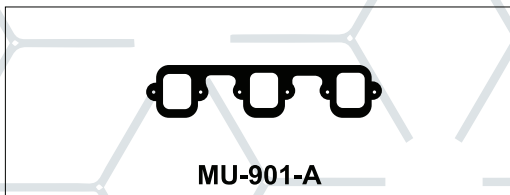
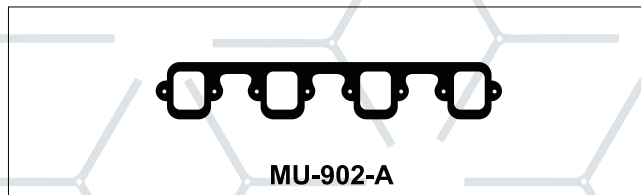
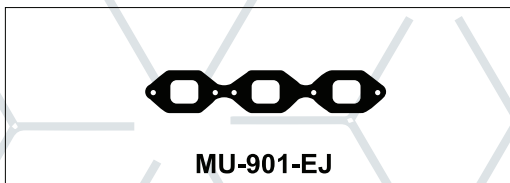
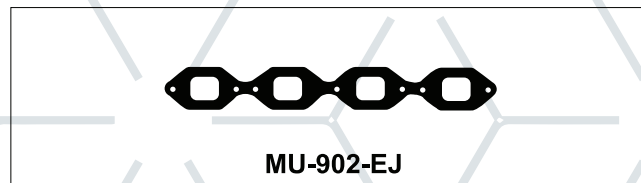
**CA-901**

**CA-902**

**PS-901**

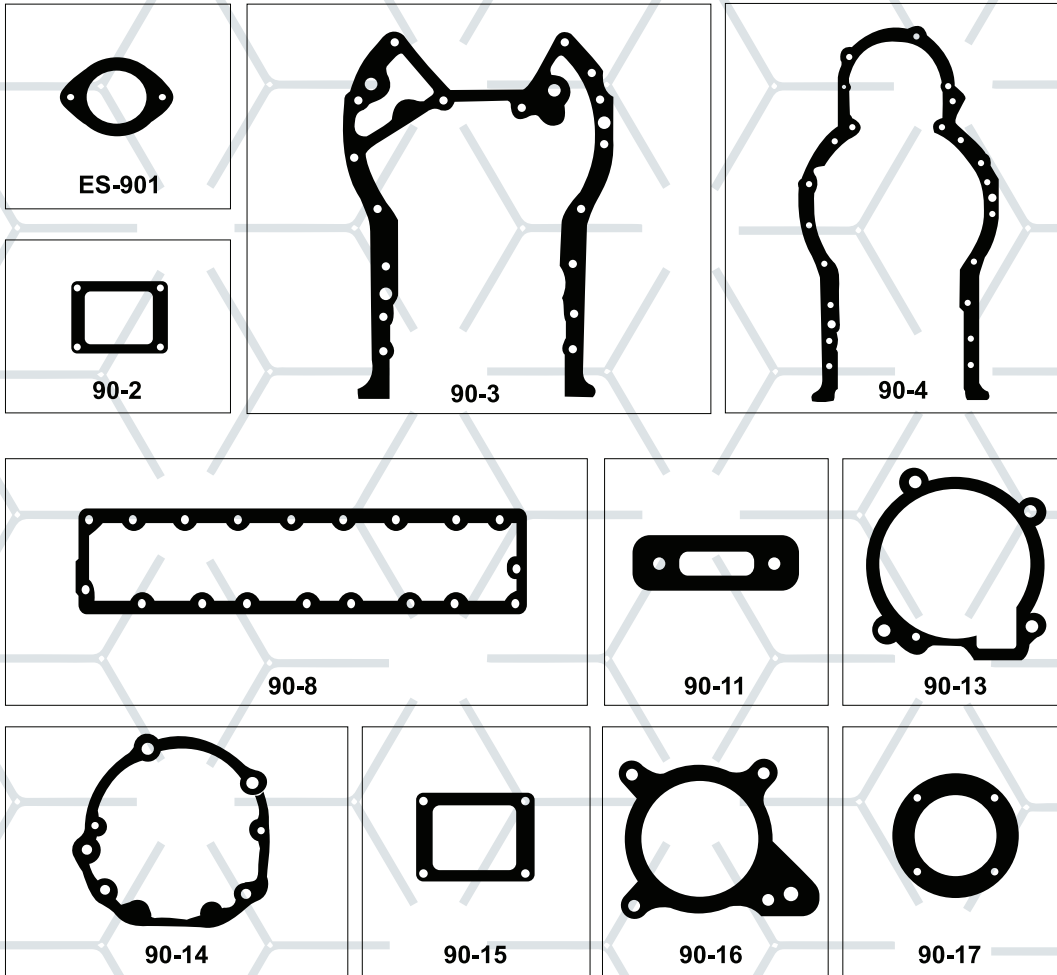
**PS-902**

**CJ-901**

**CJ-902**

**MU-901-A**

**MU-902-A**

**MU-901-EJ**

**MU-902-EJ**

DINA	CUMMINS	FIRTS	APLICACIÓN
249218	AR-63070	CA-901	Junta de Cabeza de Motor V6
289218	AR-63087	CA-902	Junta de Cabeza de Motor V8
47218-05	154019	PS-901	Junta Tapa de Punterías V6
187218-05	157018	PS-902	Junta Tapa de Punterías V8
107218-05	175726	CJ-901	Junta Cáster V6
167218-05	175727	CJ-902	Junta Cáster V8
41218-05	154415	MU-901-A	Junta Múltiple de Admisión V6
175218-05	156996	MU-902-A	Junta Múltiple de Admisión V8
	556356	MU-901-EJ	Junta Múltiple de Escape (Jgo. 2 Pzas) V6
	556355	MU-902-EJ	Junta Múltiple de Escape (Jgo. 2 Pzas) V8

**MOTORES V6 140-155 HP  
Y V8 185-210 HP**



DINA-CUMMINS

DINA	CUMMINS	FIRTS	APLICACIÓN
21218-23		ES-901	Junta del Múltiple al Tubo de Escape
27218-05	167802	90-2	Junta Cubierta Alojamiento de Agua
28218-05	168649	90-3	Junta Placa a Monoblock
29218-05	168650	90-4	Junta Caja de Engranés a Placa
35218-05	167778	90-8	Junta Cubierta Izquierda Alojamiento de Agua V6
44218-05	157911	90-11	Junta Toma de Aire a Compresor
46218-05	153433	90-13	Junta Cubierta Caja de Engranés
49218-05	167993	90-14	Junta entre Soporte y Compresor
50218-05	168069	90-15	Junta Toma Transversal de Aire
51218-05	169042	90-16	Junta Bomba de Agua
56218-05	164059	90-17	Junta Cubierta Motriz Compresor

**MOTORES V6 140-155 HP  
Y V8 185-210 HP**

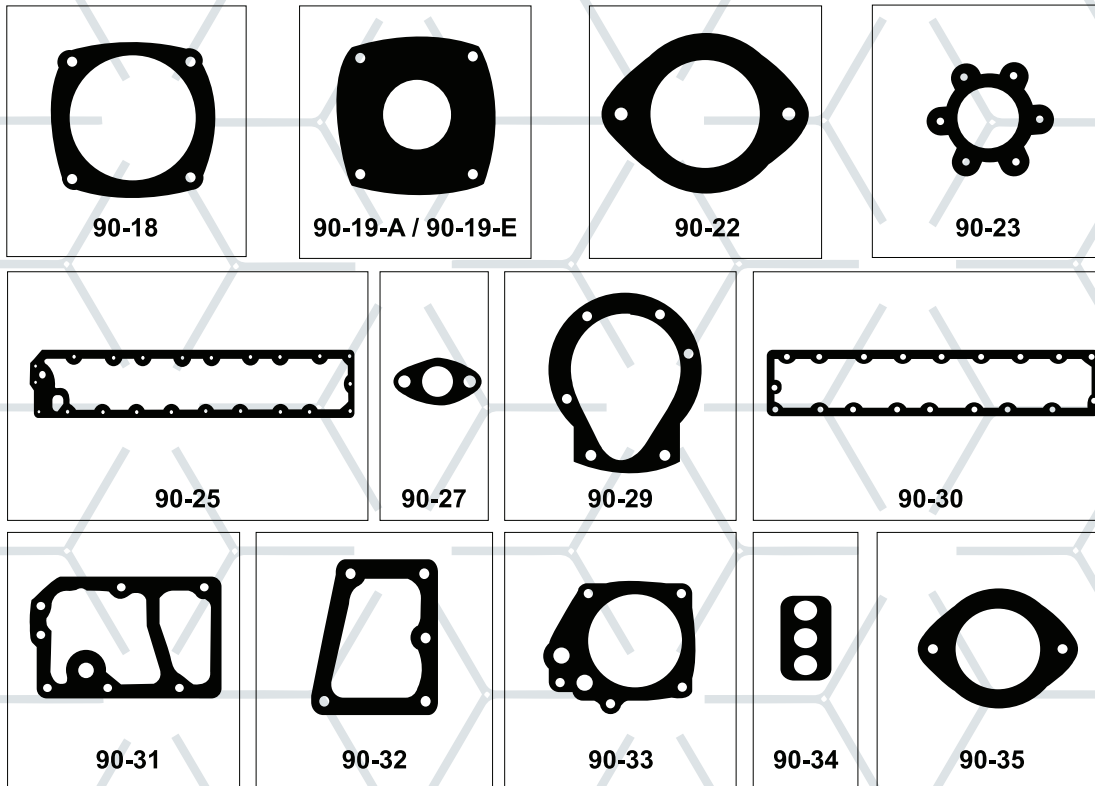

DINA-CUMMINS

DINA	CUMMINS	FIRTS	APLICACIÓN
57218-05	154018	90-18	Junta Cuerpo a Cabeza del Compresor
58218-05	154996	90-19-A	Junta Cubierta a Cabeza del Compresor (Asbesto)
58218-05	154996	90-19-E	Junta Cubierta a Cabeza del Compresor (Laminada)
98218-05		90-22	Junta de Termostato
99218-05	556457 143108	90-23	Junta Espaciado del Ventilador
109218-05	176517	90-25	Junta Cubierta Derecha Alojamiento de Agua V6
115218-05		90-27	Junta Tapa Tacómetro Bomba de Combustible
166218-05	176027	90-29	Junta Cuerpo Soporte del Compresor
169218-05	167800	90-30	Junta Cubierta Izquierda Alojamiento Agua V8
170218-05	176924	90-31	Junta Cabeza Filtro Aceite
171218-05	165153	90-32	Junta del Enfriador al Monoblock
172218-05	166407	90-33	Junta Enfriador al Filtro de Aceite
176218-05	145717	90-34	Junta Regulación de Presión
177218-05	9221	90-35	Junta para Tomar Agua
232218-05			

**MOTORES V6 140-155 HP  
Y V8 185-210 HP**

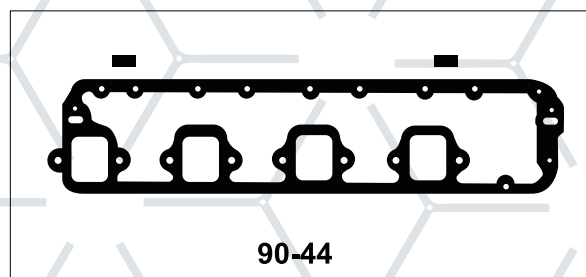
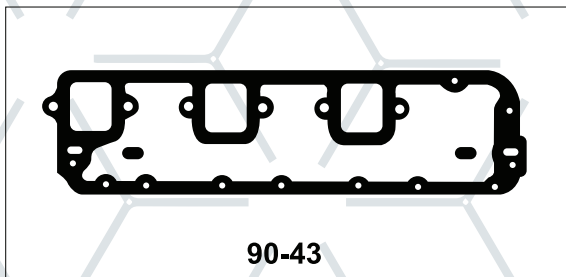
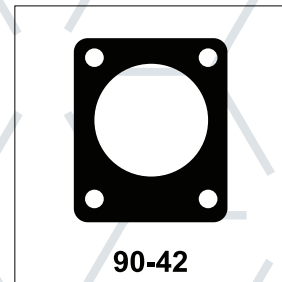
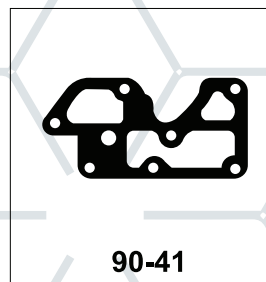
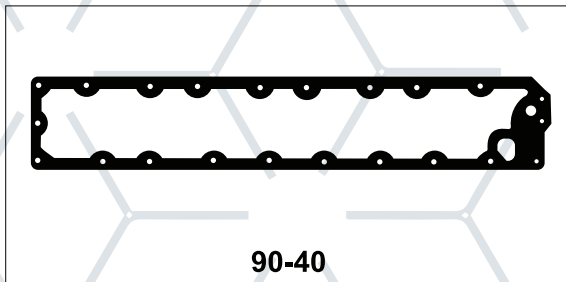
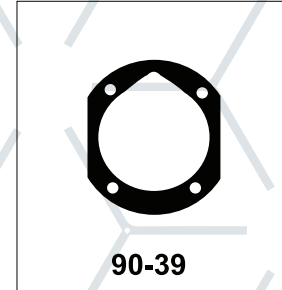
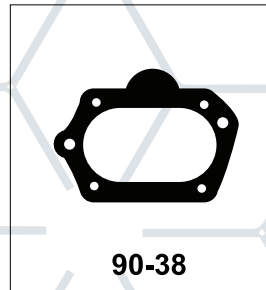
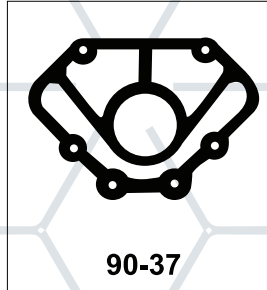
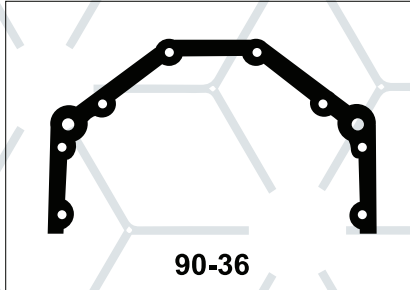

DINA-CUMMINS

DINA	CUMMINS	FIRTS	APLICACIÓN
246218-05	188396	90-36	Junta Cubierta Frontal
247218-05	550164	90-37	Junta Cubierta Árbol de Levas
251218-05	178283	90-38	Junta Cubierta Bomba de Aceite
256218-05	156826	90-39	Junta Bomba de Combustible
296218-05	552129	90-40	Junta Cubierta Derecha Alojamiento de Agua V8
45218-05	157290	90-41	Junta Cubierta Frontal Cabeza
307218-05		90-42	Junta Caja de Termostato
373218-05	553916	90-42	
377218-05	555959	90-43	Junta Cubierta Tapa de Admisión V6(Jgo. 2 pzas)
40218-05			
378218-05	555960	90-44	Junta Cubierta Tapa de Admisión V8(Jgo. 2 pzas)
174218-05			

**MOTORES V6 140-155 HP  
Y V8 185-210 HP**

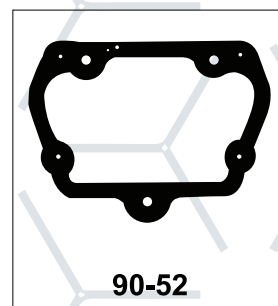
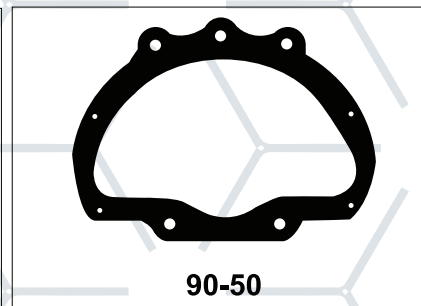
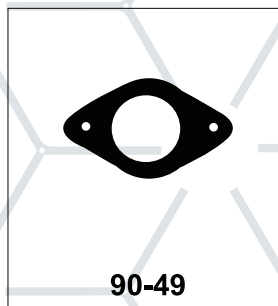
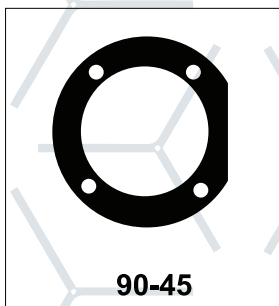

DINA-CUMMINS

DINA	CUMMINS	FIRTS	APLICACIÓN
382218-05	200817	90-45	Junta Tapa Bomba de Combustible
262218-05		90-49	Junta Base Radiador Delfín
301218-11		90-50	Junta Caja Dirección Dina 600
299218-11		90-52	Junta Caja Dirección Dina 500
47760B-05	159708	SV-901	Sello para Guía de Válvula

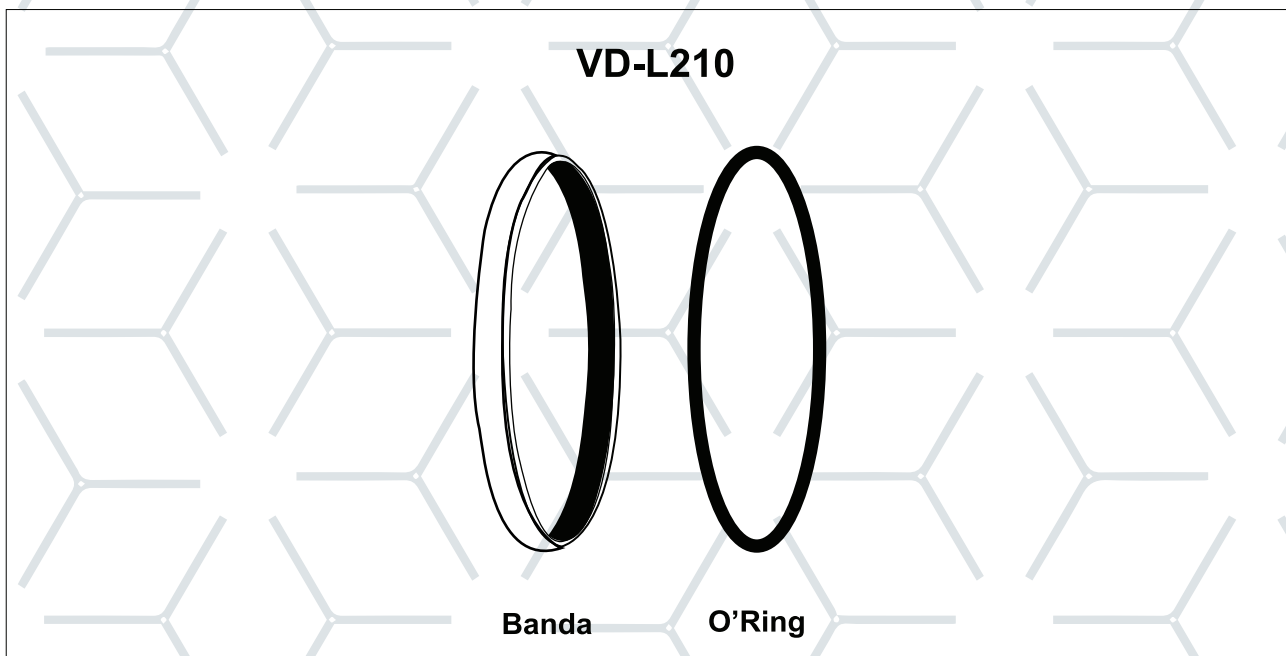

**JUEGO DE SELLOS (LIGAS ) PARA CAMISAS DE CILINDRO MOTOR DINA CUMMINS  
V6-140-155 Y V8-185-210 HP**

**MOTORES V6 140-155 HP  
Y V8 185-210 HP**

**VD-012**



90-11

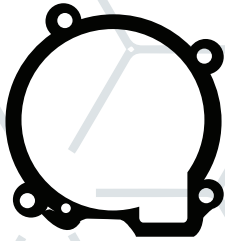

90-13

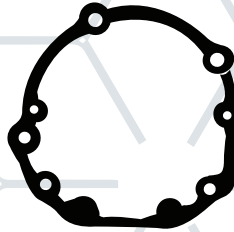

90-14

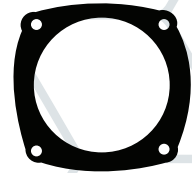

90-18



90-19



90-29



90-34



90-39

DINA-CUMMINS

**JUEGO DE JUNTAS PARA COMPRESOR CUMMINS AR-12719 MOTOR V6 140-155 HP Y V8 185-210 HP**

**VD-012-3**

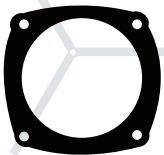

90-18



90-11

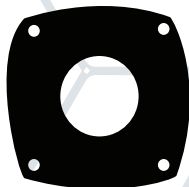

90-19



90-29



90-34

**JUEGO DE JUNTAS PARA COMPRESOR CUMMINS AR-12719 MOTOR V6 140-155 HP Y V8 185-210 HP**

**MOTORES V6 140-155 HP  
Y V8 185-210 HP**

DINA-CUMMINS

**VD-012-4**

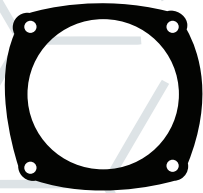

90-18

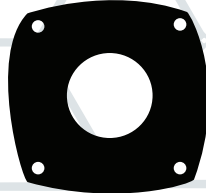

90-19



90-29

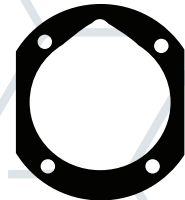

90-39



90-11



90-34

**JUEGO DE JUNTAS PARA COMPRESOR CUMMINS AR-12719 MOTOR V6 140-155 HP Y V8 185-210 HP**

**VD-014**

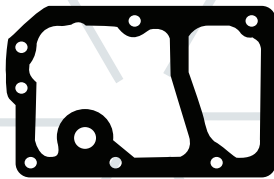

90-31

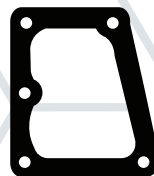

90-32



90-33

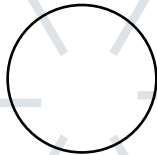

Orings

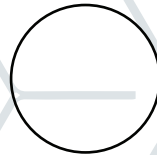

Anillo de Latón

**DINA JUEGO DE JUNTAS PARA ENFRIADOR DE ACEITE MOTORES V6 140-155 HP Y V8 185-210 HP**



# CUMMINS

## MOTOR SERIE 855 HP SMALL-CAM, BIG-CAM I, II, III Y IV Y 400

JUEGO DE JUNTAS .....	31
PIEZAS SUELTAS .....	36

## MOTOR N14 AUTOMOTIVE, COMMAND Y N14 ELECTRÓNICO

JUEGO DE JUNTAS .....	45
PIEZAS SUELTAS.....	47

VARIOS DIESEL .....	49
---------------------	----

ALAR-51477	Juego de Ligas para Camisa de Cilindro Motor 350 S.C. BIG-CAM Y N14
CJ-KIT-904	Juego de Juntas para Cáster Motor 350 S.C. BIG CAM Y N14
VD -012-350	Juego de Juntas para Compresor Motor 350 S.C. BIG CAM Y N14
VD-015	Juego de Juntas para Enfriador de Aceite Motor SMALL CAM Y BIG CAM I Y II
VD-015-N14	Juego de Juntas para Enfriador de Aceite Motor N14
VD-016	Juego de Juntas para Enfriador de Afinación Freno de Motor 350 S.C BIG CAM I, II Y III
VD-016-400	Juego de Juntas para Afinación de Motor 400
VD-016-BC4	Juego de Juntas para Afinación Freno de Motor BIG CAM IV
VD-016-LA	Juego de Juntas Afinación de Freno de Motor 350 S.C BIG CAM I, II, III
VD-016-N14	Juego de Juntas para Afinación Freno de Motor N14
VD-017	Juego de Juntas para Enfriador de Aceite Motor 350 BIG CAM III, IV Y 400
VD-021	Juego de Juntas para Intercooler Motor 350 S.C BIG CAM I Y II
VD-054	Juego de Juntas para Bomba de Aceite Motor 350 BIG CAM I, II, III, IV 400 Y N14
VD-063	Juego de Juntas para Bomba de Agua Motor 350 S.C BIG CAM I, II, III Y IV, 400
VD-063-N14	Juego de Juntas para Bomba de Agua Motor N14
VD-063-N14E	Juego de Juntas para Bomba de Agua Motor N14 ELÉCTRICO
VD-LA-904	Juego de Juntas de Ajuste Motor 350 SMALL CAM
VD-LA-905	Juego de Juntas de Ajuste Motor 350 Big Cam I, II, IV Y N14

## MOTOR L10/M11

PIEZAS SUELTAS .....	60
VARIOS DIESEL .....	61

CJ-KIT-L 10/32 Juego de Juntas para Cáster 32 orificios

CJ-KIT-L 10/34 Juego de Juntas para Cáster 34 orificios

CUMMINS L10 .....	62
CUMMINS ISX .....	63



**MOTORES NH-250, NTC-335, NTC-350 BIG CAM, I, II, IV y SERIE 400**

CUMMINS	FIRTS	APLICACIÓN
3801337	JC-904 AL3801337	Juego Completo de Juntas para Motor NH-250 NTC-350 HP Small Cam
3801340	JC-905 AL3801340	Juego Completo de Juntas para Motor Cummins NTC-350 HP Big Cam I y II
3801335	JC-906 AL3801335	Juego Completo de Juntas para Motor Cummins NTC-350 HP Big Cam III
3801330	MJ-904-1 AL3801330	Medio Juego Superior Motor NH-250, NTC-335 NTC-350 Big Cam I, II, III
3014459	MJ-904-2 AL3014459	Medio Juego Inferior Motor NH-250, NTC-335 HP
3801468	MJ-905-2 AL3801468	Medio Juego Inferior Motor NTC-350 HP BIG CAM I, II
3801235	MJ-906-2 AL3801235	Medio Juego Inferior Motor NCT-350 HP BIG CAM III
3801328	KJ-904 AL3801328	Juego de Juntas para Una Cabeza Motor NH-250 NTC-335 Y 350 HP
3801754	MJ-904-1400 AL3801754	Medio Juego Superior Motor NTC-350 Serie 400
3801451	MJ-904-1400SF AL3801451	Medio Juego Superior Motor NTC-350 Serie 400 con Sincronización Fija
3801454	MJ-904-2400 AL3801454	Medio Juego Inferior Motor NTC-350 Serie 400
	KJ-904-1400	Juego de Juntas para una Cabeza Motor HN-350 Serie 400
	KJ-904-1400SF	Juego de Juntas para una Cabeza Motor HN-350 Series 400 con Sincronización Fija
3803040	MJ-904-1BC4 AL3803040	Medio Juego Superior Motor NTC-350 HP BIG CAM IV
3803041	MJ-904-2BC4 AL3803041	Medio Juego Inferior Motor NTC-350 HP BIG CAM IV
3803150	KJ-904-1BC4	Juego de Juntas para Una Cabeza Motor NTC-350 HP BIG CAM IV

**CUMMINS**



# CUMMINS 350 HP SMALL CAM, BIG CAM I, II, III

## MJ-904-1 AL3801330 JUEGO SUPERIOR 350 SMALL CAM BIG CAM I, II, III

## KJ-904-1 AL3801328

## MJ-904-2 AL3014459 JUEGO INFERIOR 350 SMALL CAM

Original	Firts	Cantidad MJ-904-1	MJ-904-1 Austero	KJ-904	Cantidad KJ-904 Austero	Original	Firts	Cantidad MJ-904-2
9221	94-2	1	0	0	0	154996	90-19-E	1
70441	94-6	1	0	0	0	3067616	94-1	2
116982	94-9	6	6	6	2	9221	94-2	1
187589	94-17	3	3	1	1	65274	94-3	1
3012972	94-20	1	0	0	0	67963	94-4	1
216487	94-30	1	1	1	0	3069098	94-5	2
195950	94-31	1	1	0	0	3069103	94-7	2
208188	94-32	1	1	1	0	121779	94-10	1
252164	94-41	3	3	1	1	3031434	94-11	1
215044	94-43	1	1	0	0	3069101	94-12	1
3019158	94-44	1	1	0	0	3002385	94-13	1
3047402	CA-904	3	3	1	1	157551	94-16	1
3020980	PS-905-LAN	3	3	1	1	194982	94-18	1
3008591	MU-904-A	3	3	3	2	194983	94-19	1
3020943	MU-904-E	6	6	6	2	156089	94-21	1
3069177	ES-904-T	1	1	1	1	203145	94-22	1
10180	O'RING	3	0	1	0	218027	94-25	1
131026	O'RING	12	8	12	4	151911	94-26	2
156545	O'RING	3	3	3	1	199064	94-27	1
193736	O'RING	18	18	6	8	173161	94-29	1
195952	O'RING	4	0	0	0	134385	94-36	1
212161	O'RING	2	0	2	0	214633	DT-904	1
3024709	O'RING	6	0	4	0	120819	LA-904-E	3
43463A	O'RING	1	0	1	0	9266	LA-904-M	3
70624	O'RING	4	4	4	0	9266A	LA-904-D	3
S-100-3-A	O'RING	4	0	0	4	3049408	CJ-904-2	1
3082550	O'RING	0	0	0	1		O'RING	1
2-229	O'RING	3	0	1	1		O'RING	6
2-230	O'RING	0	0	0	1		O'RING	6
2-231	O'RING	0	0	0	1	156545	O'RING	1
2-232	O'RING	0	0	0	1	212161	O'RING	2
						43463A	O'RING	2
						65260	O'RING	1

JC-904 ( JUEGO COMPLETO AL3801337 ) = MJ-904-1 + MJ-904-2

# CUMMINS 350 HP SMALL CAM, BIG CAM I, II, III



## MJ-905-2 AL3801468 JUEGO INFERIOR BIG CAM I y II

Original	Firts	Cantidad MJ-905-2
154996	90-19-E	1
3067616	94-1	2
65274	94-3	1
67963	94-4	1
3069098	94-5	2
70441	94-6	1
3069103	94-7	1
121907	94-11	1
3069101	94-12	1
3002385	94-13	1
156089	94-21	1
203145	94-22	1
218067	94-25	1
199064	94-27	1
157551	94-28	1
176027	90-29	1
3010030	94-34	1
3008017	94-35	1
3011931	94-37	2
218245	94-38	1
3021705	DT-905	1
3049408	CJ-904-2	1
3074400	LA-905-M	3
3074401	LA-905-D	3
3074402	LA-905-E	3
3074404	LA-905-G	3
	O'RING	6
	O'RING	6
212161	O'RING	4
65260	O'RING	1

## MJ-906-2 AL3801235 JUEGO INFERIOR BIG CAM III

Original	Firts	Cantidad MJ-906-2
3005592	90-23	1
176027	90-29	1
3067616	94-1	1
65274	94-3	1
67963	94-4	1
3069098	94-5	1
3069103	94-7	1
3069101	94-12	1
3002385	94-13	1
3049688	94-25	1
157551	94-28	1
3024960	94-32	1
3008017	94-35	1
3011931	94-37	1
3047465	94-45	1
3047464	94-46	1
3027496	94-47	1
3014778	90-56	1
3031434	90-58	1
3021705	DT-905	1
3049408	CJ-904-2	1
3074400	LA-905-M	3
3074401	LA-905-D	3
3074402	LA-905-E	3
3074404	LA-905-G	3
215705	O'RING	1
3007442	O'RING	6
3018095	O'RING	1
3029847	O'RING	1
3030808	O'RING	1
3030969	O'RING	1
3034986	O'RING	1
3045979	O'RING	1
	O'RING	1
67946	ROLDANA	2

CUMMINS

JC-905 ( JUEGO COMPLETO AL3801340 ) = MJ-904-1 + MJ-905-2  
 JC-905 ( JUEGO COMPLETO AL3801335 ) = MJ-904-1 + MJ-906 -2

MJ-904-1400SF AL3801451 JUEGO SUPERIOR 400 HP SINCRONIZACIÓN FIJA			KJ-904-400SF	MJ-904-1400 AL3801754 JUEGO SUPERIOR 400 HP			KJ-904-400
Original	Firts	Cantidad MJ-904-1400SF	Cantidad KJ-904-400SF	Original	Firts	Cantidad MJ-904-1400	Cantidad MJ-904-400
3201386	90-11	1	1	3024960	94-33	1	1
3017750	94-17	3	1	201048	97-2	1	1
3024960	94-33	1	1	3042551	94-17-400	3	1
3040056	94-62	1	1	14848	94-41-400	3	1
3040057	94-63	1	1	3047402	CA-904	3	1
13294	94-41-T	3	1	3069177	ES-904-T	1	1
3047402	CA-904	3	1	3008591	MU-904-A	3	3
3069177	ES-904-T	1	1	3020943	MU-904-E	6	6
3008591	MU-904-A	3	3	3058532	PS-907-400	3	1
3020943	MU-904-E	6	6	109080	O'RING	1	0
3054841	PS-905-LAN	3	1	131026	O'RING	12	12
109080	O'RING	1	0	212161	O'RING	2	0
131026	O'RING	12	12	3037537	O'RING	1	0
156545	O'RING	3	0	3050667	O'RING	6	0
212161	O'RING	2	0	3050867	O'RING	6	0
3063618	O'RING	6	4	3058654	O'RING	6	0
43463A	O'RING	1	0	3062587	O'RING	18	18
70624	O'RING	4	4	3082550	O'RING	3	0
				43463-A	O'RING	1	0
				3063618	SELLO	6	4

**MJ-904-2-400 AL3801454 JUEGO INFERIOR 400 HP**

Original	Firts	Cantidad	Original	Firts	Cantidad	Original	Firts	Cantidad
3005592	90-23	1	3069014	94-47	1	109080	O'RING	1
176027	90-29	1	3014778	94-56	1	212161	O'RING	2
3067616	94-1	1	3067613	94-58	1	215705	O'RING	1
3069097	94-3	1	3040056	94-62	1	3007442	O'RING	6
3069098	94-5	1	3040057	94-63	1	3018095	O'RING	1
3069103	94-7	1	3049408	CJ-904-2	1	3029847	O'RING	1
3069101	94-12	1	3021705	DT-905	1	3030808	O'RING	1
3002385	94-13	1	3074400	LA-905-M	3	3030969	O'RING	1
157551	94-28	1	3074401	LA-905-D	3	3034986	O'RING	1
3008017	94-35	1	3074402	LA-905-E	3	3045979	O'RING	1
3047465	94-45	1	3074404	LA-905-G	3	67946	ROLDANA	2
3047464	94-46	1						

MJ-904-1BC4 AL3803040 JUEGO SUPERIOR BIG CAM IV				MJ-904-2BC4 AL3803041 JUEGO INFERIOR BIG CAM IV		
Original	Firts	Cantidad MJ-904-1BC4	Cantidad KJ-904-BC4	Original	Firts	Cantidad M-904-2-BC4
3052877	94-60	1	1	3005592	90-23	1
201048	97-2	1	1	176027	90-29	1
3047402	CA-904	3	1	3067616	94-1	1
3058532	PS-907-400	3	1	3069097	94-3	1
3069177	ES-904-T	1	1	3069098	94-5	1
3049187	94-17-BC4	3	1	3069103	94-7	1
3053132	94-41-BC4	3	1	3069101	94-12	1
3008591	MU-904-A	3	3	3002385	94-13	1
3020943	MU-904-E	6	6	3069102	94-25	1
3063618	SELLO	6	4	157551	94-28	1
109080	O'RING	2	0	3014778	94-56	1
131026	O'RING	12	12	3067613	94-58	1
212161	O'RING	2	0	3069176	94-59	1
3037537	O'RING	1	0	3052877	94-60	1
3050667	O'RING	6	0	3052136	94-61	1
3050867	O'RING	6	0	3049408	CJ-904-2	1
3052587	O'RING	18	18	3021705	DT-905	1
3058654	O'RING	6	0	3074400	LA-905-M	3
3082550	O'RING	3	0	3074401	LA-905-D	3
43463-A	O'RING	1	0	3074402	LA-905-E	3
				3074404	LA-905-G	3
				109080	O'RING	1
				212161	O'RING	2
				215705	O'RING	1
				3007442	O'RING	6
				3029847	O'RING	1
				3049221	O'RING	4
				3049302	O'RING	2
				67946	ROLDANA	2

CUMMINS

JC-904-BC4 (JUEGO COMPLETO) = MJ-904-1BC4 + MJ-904-2BC4

**MOTORES NH-250, NTC-335, NTC-350,  
BIG CAM I, II, III, IV Y 400 HP**

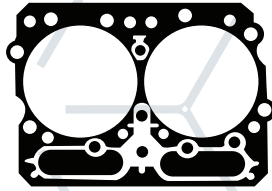

CA-904

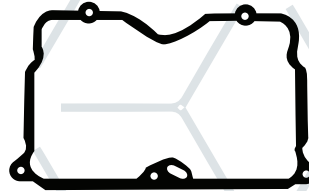

PS-905-LA

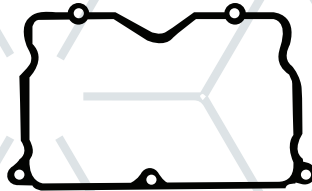

PS-905-LAN

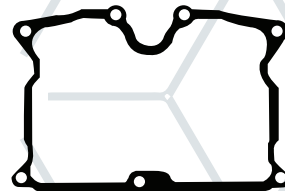

PS-907-400

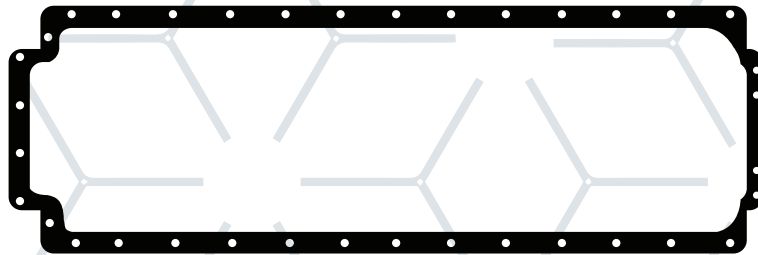

CJ-904-2

CUMMINS

ORIGINAL	FIRTS	APLICACIÓN
3047402	CA-904	Junta de Cabeza para Motor NH-250 NTC-335, NTC-350, BIG CAM I, II, III, IV, 400 y N14
3049998		
202125		
3036126		
3036128		
3009999	PS-905-LA	Junta de Puntería Motor NTC-350 BIG CAM I, II y III
3058532	PS-905-LAN	Junta de Puntería Motor BIG CAM (Nuevo Diseño)
3054841	PS-907-400	Junta de Puntería Motor 400HP y BC IV
3067460	CJ-904-2	Junta Cáster Unitario NTC-335, NTC-350 BIG CAM I, II, III, IV, 400 y N14
3032861		
3049408		

**MOTORES NH-250, NTC-335, NTC-350,  
BIG CAM I, II, III, IV Y 400 HP**

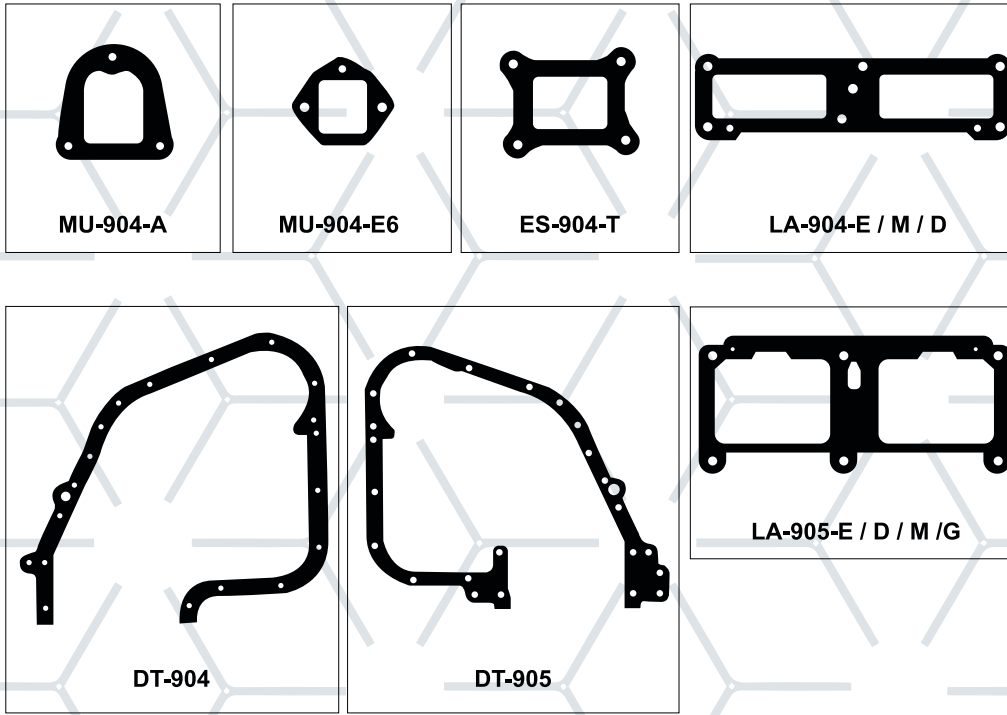

CUMMINS

ORIGINAL	FIRTS	APLICACIÓN
202961	MU-904-A	Junta Múltiple de Admisión (juego de 3 pzas.)
3008591	MU-904-E6	Junta Múltiple de Escape (juego de 6 pzas.)
142234	ES-904-T	Junta Base Turbo Cargador
3020943	DT-904	Junta Tapa de Distribución Small Cam
3069177	DT-905	Junta Tapa de Distribución Big Cam
199327	LA-904-E	Junta SMALL CAM Espesor 0.032"
3021704	LA-904-M	Junta SMALL CAM Espesor 0.016"
120819	LA-904-D	Junta SMALL CAM Espesor 0.010"
9266	LA-905-E	Junta BIG CAM Espesor 0.020"
9266-A	LA-905-D	Junta BIG CAM Espesor 0.010"
3020003 3074402	LA-905-M	Junta BIG CAM Espesor 0.016"
3020001 3074401	LA-905-G	Junta BIG CAM Espesor 0.032"
3020002 3074400		
3020000 3074404		

**MOTORES NH-250, NTC-335, NTC-350,  
BIG CAM I, II, III, IV Y 400 HP**

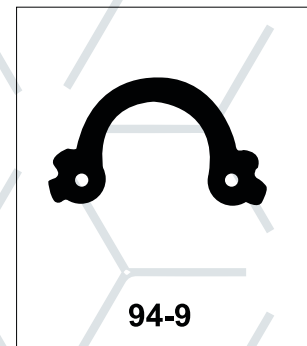
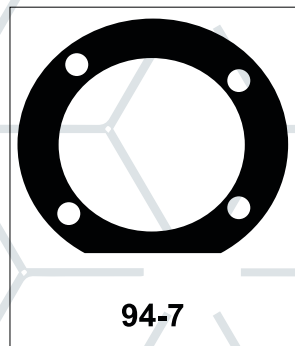
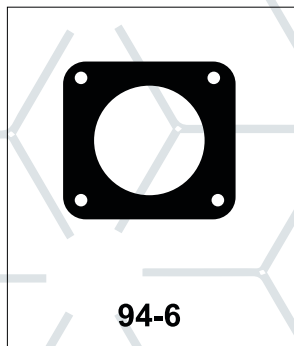
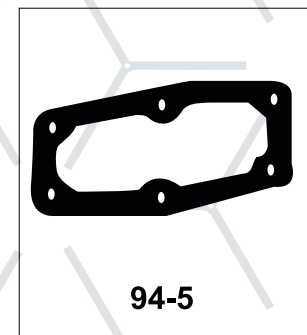
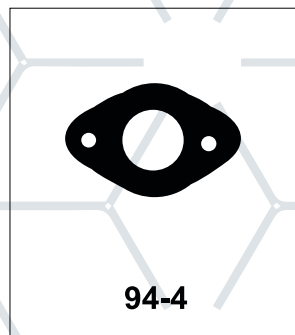
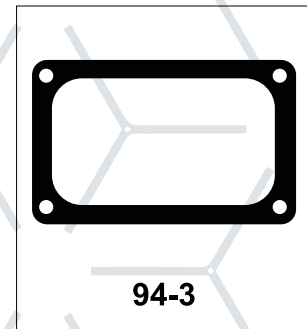
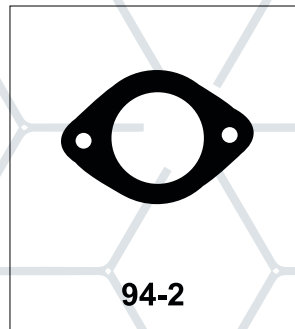
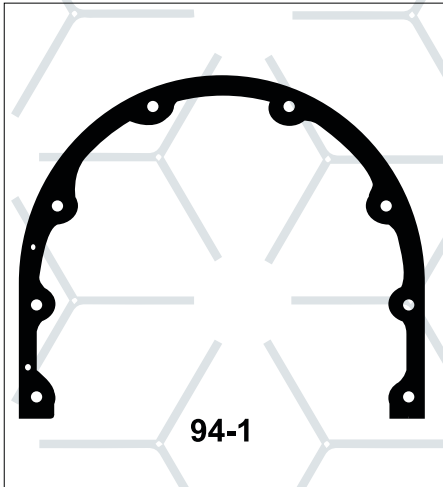

CUMMINS

ORIGINAL	FIRTS	APLICACIÓN
40662-A	94-1	Junta Brida Cigüeñal
9221	94-2	Junta Toma de Agua Enfriador
65274	94-3	Junta Tapa Bayoneta
67963	94-4	Junta Tapa Succión Aceite Block
70098-1	94-5	Junta Tapa Registro Agua Block
3069098	94-6	Junta Tapa Bomba de Agua
70441	94-7	Junta Bomba de Combustible
102996	94-7	Junta Bomba de Combustible
3069103	94-7	Junta Bomba de Combustible
116982	94-9	Seguro de Escape Media Luna

**MOTORES NH-250, NTC-335, NTC-350,  
BIG CAM I, II, III, IV Y 400 HP**

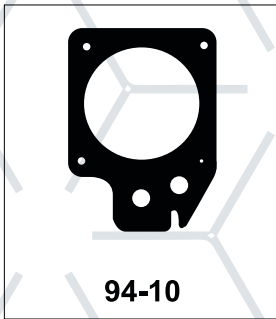

**94-10**

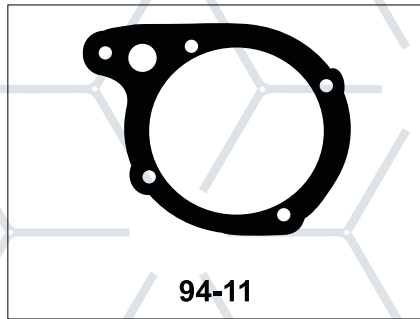

**94-11**

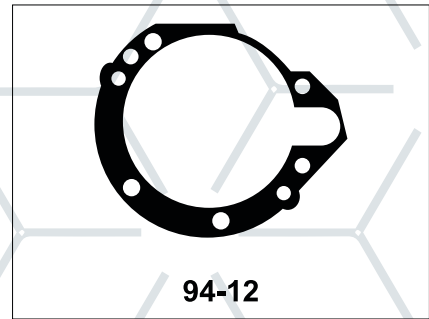

**94-12**

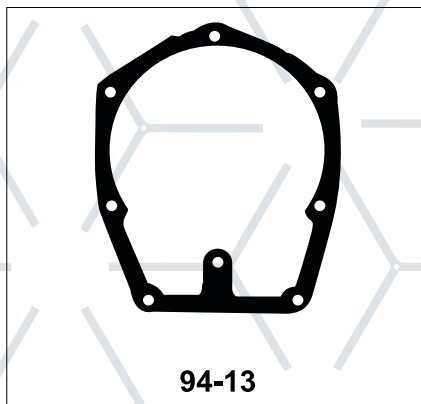

**94-13**

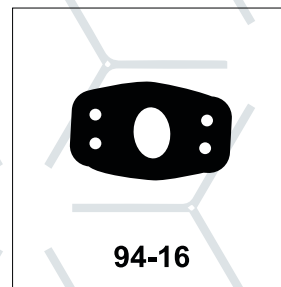

**94-16**

**CUMMINS**

ORIGINAL	FIRTS	APLICACIÓN
121779	94-10	Junta Enfriador a Block
121907	94-11	Junta de Aceite Alta Presión
121937		
200809	94-12	Junta Impulsor Compresor
3069101		
130226	94-13	Junta del Soporte de Bomba de Agua
157551	94-16	Junta Tubo de Succión Cáter

**MOTORES NH-250, NTC-335, NTC-350,  
BIG CAM I, II, III, IV Y 400 HP**

CUMMINS

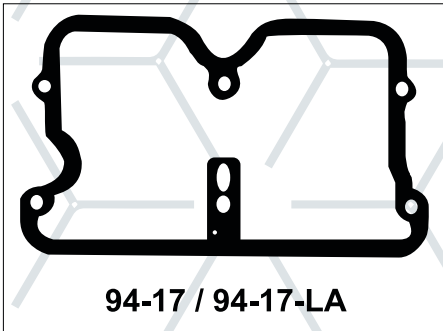

94-17 / 94-17-LA

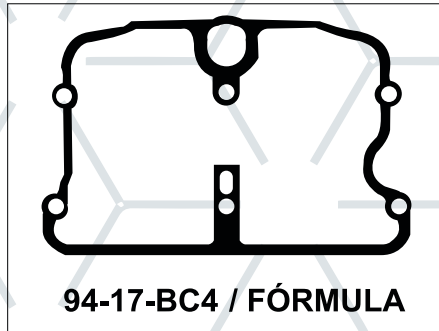

94-17-BC4 / FÓRMULA

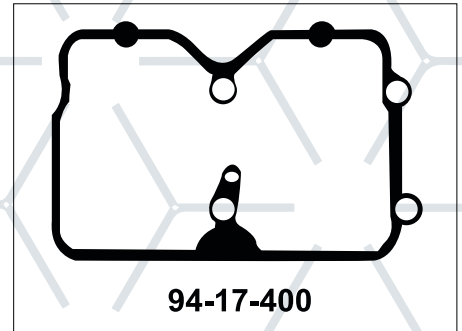

94-17-400



94-18

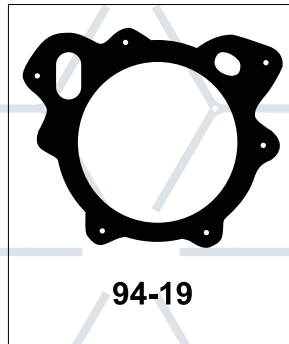

94-19

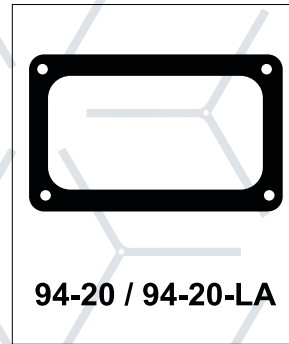

94-20 / 94-20-LA

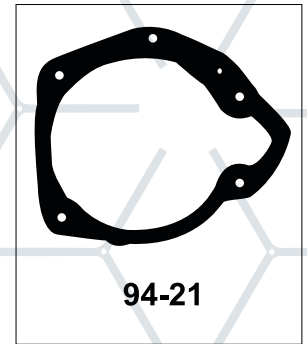

94-21

ORIGINAL	FIRTS	APLICACIÓN
187589	94-17	Junta Banco de Balancines
3017750	94-17-LA	Junta Banco de Balancines (Laminada)
3049187	94-17-BC4	Junta Banco de Balancines Motor BIG CAM IV
3042551	94-17-400	Junta Freno de Motor 400 HP
194982	94-18	Junta Tapa Filtro Aceite Motor NTC 335
194983	94-19	Junta Soporte Cuerpo Enfriador Motor NTC 335
199568	94-20	Junta Tubo Múltiple de Admisión
3012972	94-20-LA	Junta Tubo Múltiple de Admisión (Laminada)
156089	94-21	Junta Impulsor Compresor

**MOTORES NH-250, NTC-335, NTC-350,  
BIG CAM I, II, III, IV Y 400 HP**

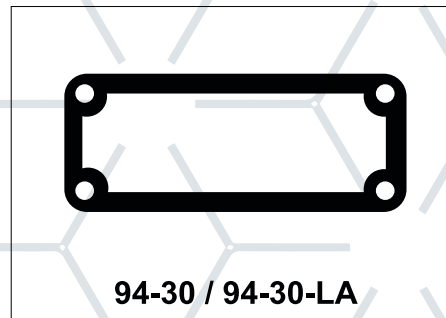
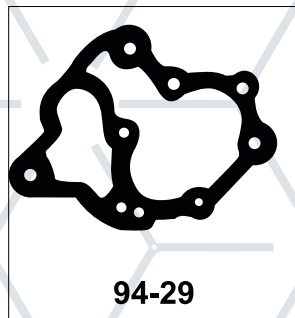
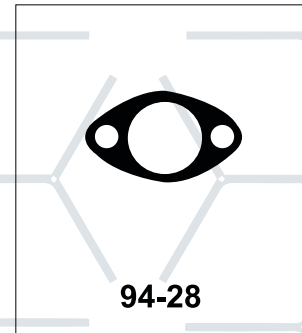
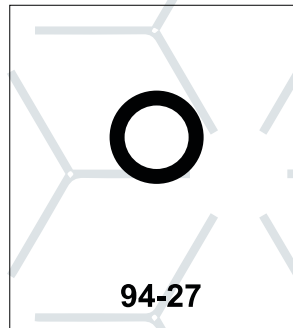
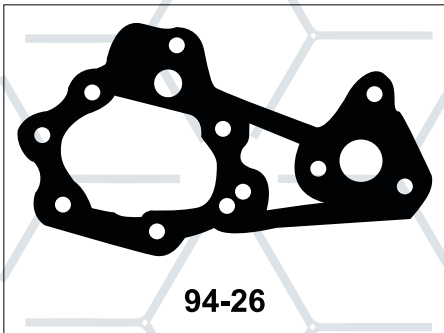
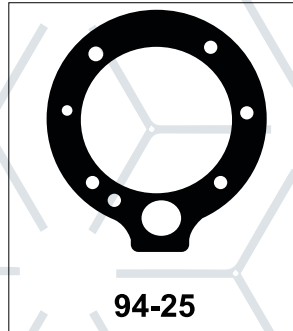
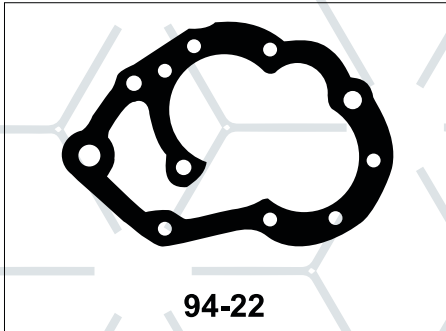

CUMMINS

ORIGINAL	FIRTS	APLICACIÓN
203145	94-22	Junta Tapa Bomba de Aceite
218027	94-25	Junta Acoplamiento Compresor a Impulsor
3069102	94-26	Junta Bomba Cuerpo de Aceite
151911	94-27	Junta para Campana Motor (corcho)
199064	94-28	Junta Flange Succión Cárter
67963-A	94-29	Junta Cuerpo Bomba de Aceite
157551	94-30	Junta Tubo Admisión de Aire
173161	94-30	Junta Tubo Admisión de Aire ( laminada )
1958662	94-30-LA	Junta Tubo Admisión de Aire ( laminada )
216487	94-30-LA	Junta Tubo Admisión de Aire ( laminada )

**MOTORES NH-250, NTC-335, NTC-350,  
BIG CAM I, II, III, IV Y 400 HP**

CUMMINS

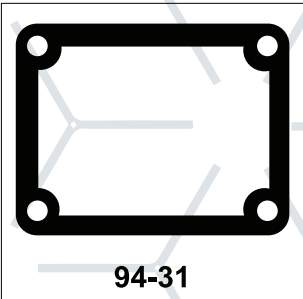

94-31

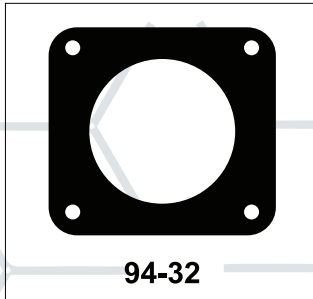

94-32

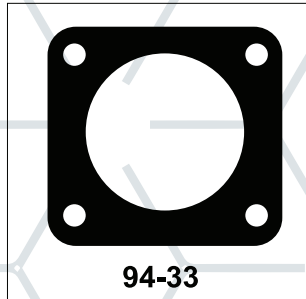

94-33

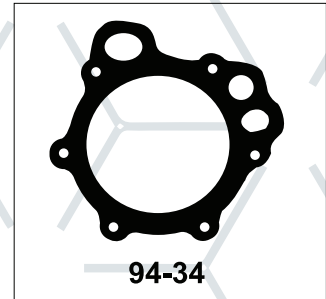

94-34

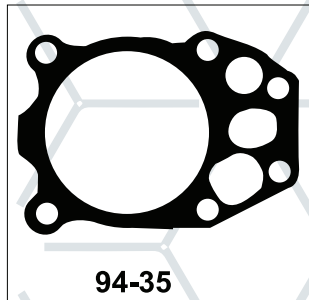

94-35

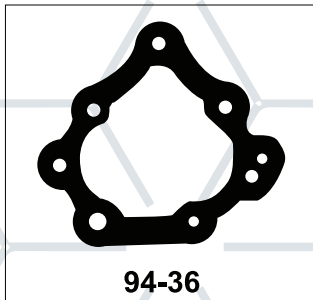

94-36

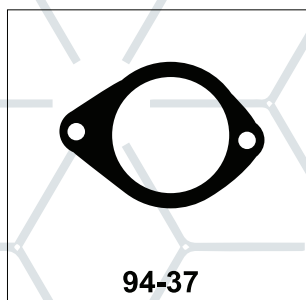

94-37

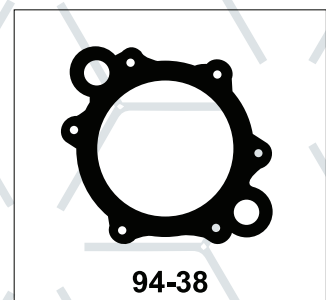

94-38

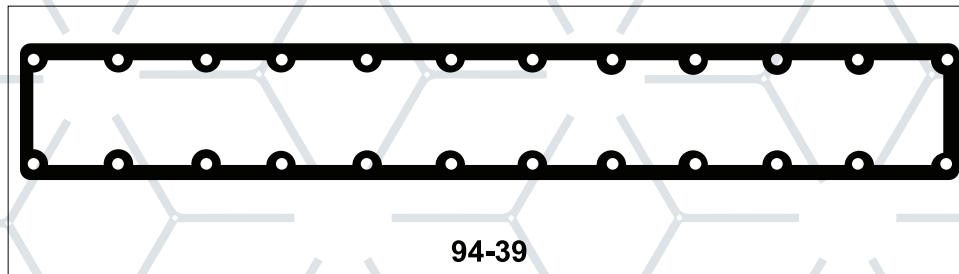

94-39

ORIGINAL	FIRTS	APLICACIÓN
195950	94-31	Junta Tapa de Admisión de Aire
208128	94-32	Junta Tubo Termostato
208132	94-33	Junta Caja Termostato
3024960	94-34	Junta Soporte Enfriador de Aceite
211053	94-35	Junta Enfriador de Aceite Block
3010030	94-36	Junta Tapa Bomba de Aceite
211054	94-37	Junta Tubo Transferencia de Agua
3008017	94-38	Junta Tapa Enfriador de Aceite
134385	94-39	Junta Base Intercambiador de Calor Múltiple de Admisión
210805		
3011931		
218245		
195792		
216486		

**MOTORES NH-250, NTC-335, NTC-350,  
BIG CAM I, II, III, IV Y 400 HP**

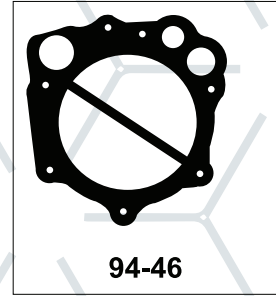
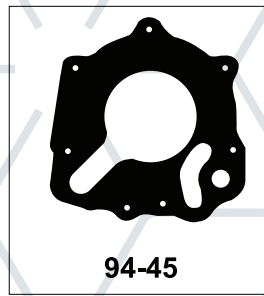
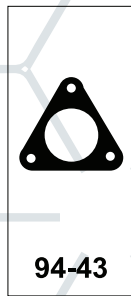
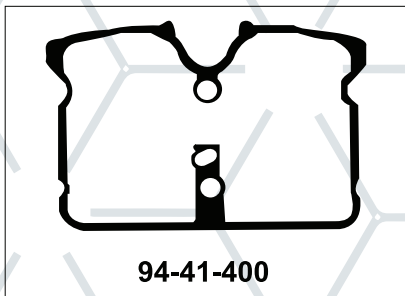
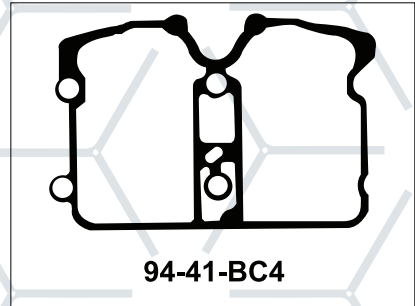
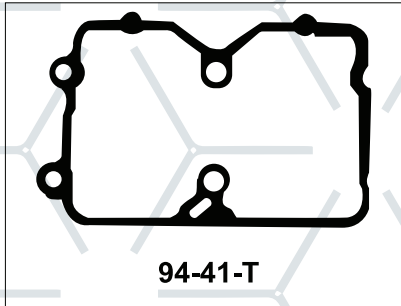
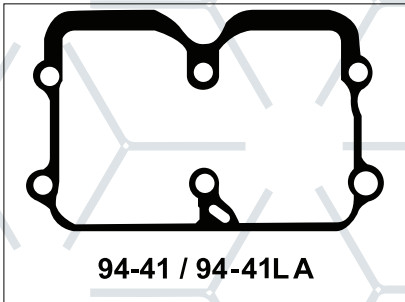

CUMMINS

ORIGINAL	FIRTS	APLICACIÓN
252164	94-41	Junta Freno de Motor
252164	94-41-LA	Junta Freno de Motor (Laminada)
13294	94-41-T	Junta Freno de Motor
3045533	94-41-BC4	Junta Freno de Motor BIG CAM IV
3053132	94-41-400	Junta Freno de Motor 400 HP
14848	94-43	Junta Base Tubo Salida de Agua
215044	94-44	Junta Caja Termostato
3019158	94-45	Junta Cubierta Enfriadora Aceite Motor
3018693	94-46	Junta Cuerpo Enfriador Aceite Motor
3047465		
3018696		
3047464		

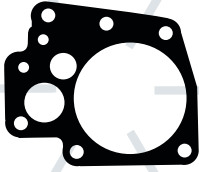
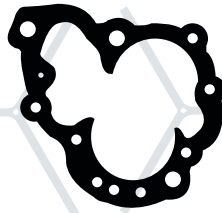
**MOTORES NH-250, NTC-335, NTC-350,  
BIG CAM I, II, III, IV Y 400 HP**

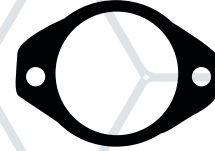
**94-47**

**94-56**

**94-57**

**94-57-X / 94-57-XA  
94-57-XAL**

**94-58**

**94-59**

**94-60**

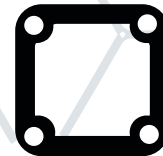
**94-61**

**94-62**

**94-63**
**CUMMINS**

ORIGINAL	FIRTS	APLICACIÓN
3027496	94-47	Junta Tapa Enfriador Aceite Motor
3069014	94-56	Junta Cuerpo Bomba de Aceite
3014778	54-57	Junta Tapa Bomba de Aceite (Corcho)
3004242	94-57-X	Junta Tapa Bomba de Aceite (Corcho)
	94-57-XA	Junta Tapa Bomba de Aceite (Asbesto)
154916	94-57-XAL	Junta Tapa Bomba de Aceite Hidráulico (Laminada)
3031434	94-58	Junta Base Bomba de Aceite Baja Presión
3067613	94-59	Junta Soporte Enfriador de Aceite
3069176	94-60	Junta Alojamiento Termostato
3052877	94-61	Junta Enfriador de Aceite
3052136	94-62	Junta Alojamiento Termostato
3040056	94-63	Junta Tapa Termostato
3040057		

# CUMMINS N14



MJ-907-1 AL3803444 JUEGO SUPERIOR MOTOR N14 AUTOMOTIVE Y COMMAND			KJ-907-1 AL3803445	MJ-907-2 AL3803613 / 38033376 JUEGO INFERIOR MOTOR N14 AUTOMOTIVE Y COMMAND		
Original	Firts	Cantidad MJ-907-1	Cantidad KJ-907	Original	Firts	Cantidad MJ-907-2
3064313	97-1	1	0	3005592	90-23	1
3202117	97-2	1	1	176027	90-29	1
3076292	97-17-N14	3	1	3067616	94-1	1
3076284	97-41-N14	3	1	3068466	94-3	1
3066311	PS-907-N14	3	1	3069098	94-5	1
3047402	CA-904	3	1	157551	94-28	1
3008591	MU-904-A	3	3	3014778	94-56	1
3020943	MU-904-E	6	6	3067613	94-58	1
3069177	ES-904-T	1	1	3072341	97-3	1
3050867	BARRIL	6	2	3066298	97-4	1
3068510	LIGA	1	1	3070447	97-5	1
131026	O'RING	12	8	3070478	97-6	1
3001340	O'RING	6	2	3069678	97-7	2
3033898	O'RING	1	0	3076225	97-8	1
3037537	O'RING	1	0	3076228	97-9	1
3050667	O'RING	6	4	3076226	97-10	1
3052587	O'RING	18	6	3076522	97-13	1
3066211	O'RING	1	1	3049408	CJ-904-2	1
3909397	O'RING	6	2	3067618	DT-905	1
43463A	O'RING	2	0	3074400	LA-905-M	3
8078	ROLDANA	3	3	3074401	LA-905-D	3
3042401	SELLO	1	1	3074402	LA-905-E	3
				3074404	LA-905-G	3
				215705	O'RING	1
				3029847	O'RING	1
				3033898	O'RING	2
				3049221	O'RING	1
				3068527	O'RING	6
				3072375	O'RING	2
				67946	ROLDANA	2

CUMMINS

JC-907 ( JUEGO COMPLETO ) = MJ-907-1 + MJ-907-2

**CUMMINS**

MJ-907-1E AL4089371 JUEGO SUPERIOR CUMMINS N14 ELECTRÓNICO			KJ-907-1E AL3804291
Original	Firts	Cantidad MJ-907-1E	Cantidad KJ-907-1E
8078	ROLDANA	3	3
3064313	97-1	1	0
3865195	97-14	1	0
3065236	97-15	1	0
3076292	97-17-N14	3	1
201048	97-2	1	0
3047402	CA-904	3	1
3069177	ES-904-T	1	1
3008591	MU-904-A	3	3
3020943	MU-904-E	6	6
3865235	MU-907-E	3	3
3066311	PS-907-N14	3	1
43463A	O'RING	3	0
131026	O'RING	12	8
3037537	O'RING	1	0
3050667	O'RING	6	4
3068510	O'RING	1	0

**MOTOR N14**

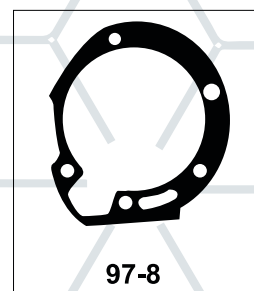
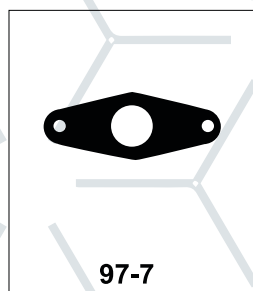
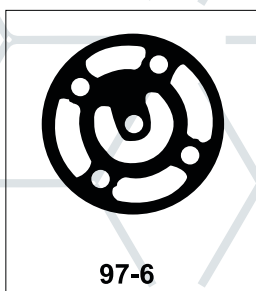
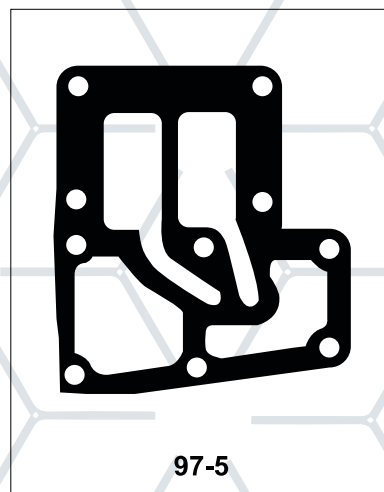
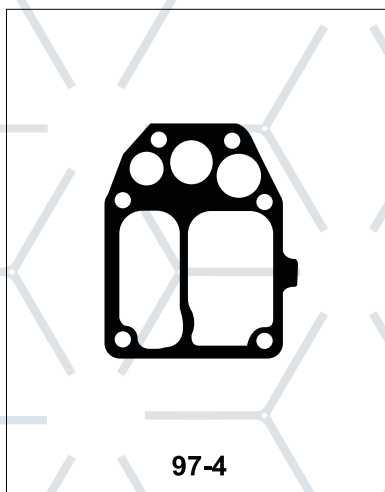
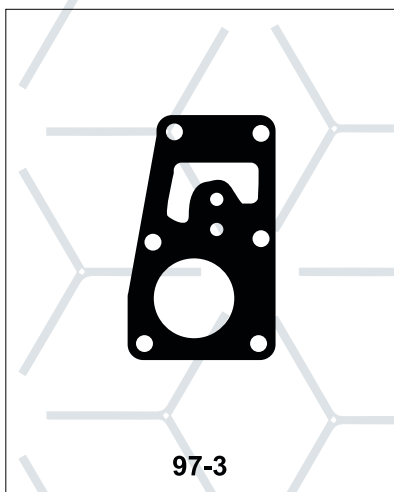
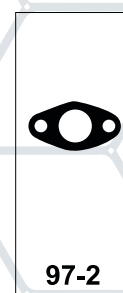
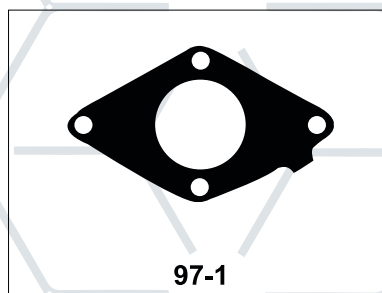
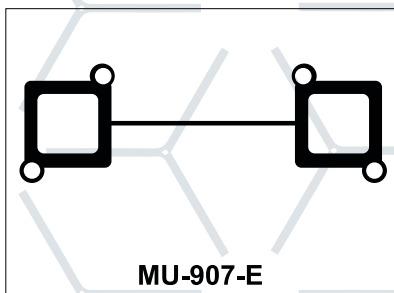

CUMMINS

ORIGINAL	FIRTS	APLICACIÓN
3865235	MU-907-E	Junta Múltiple de Admisión (Electrónico)
3064313	97-1	Junta de Termostato
3202117	97-2	Junta Conexión Turbo Cargador
3072341	97-3	Junta Conexión Enfriador de Aceite
3066298	97-4	Junta Soporte Enfriador de Aceite
3070477	97-5	Junta Soporte Enfriador de Aceite
3070478	97-6	Junta Cabeza del Filtro
3069678	97-7	Junta Alojamiento Enfriador de Aceite
3076225	97-8	Junta Toma de Fuerza del Compresor

**MOTOR N14**

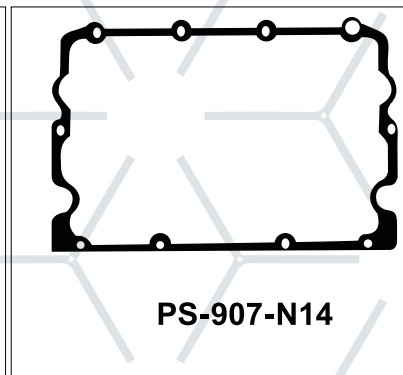
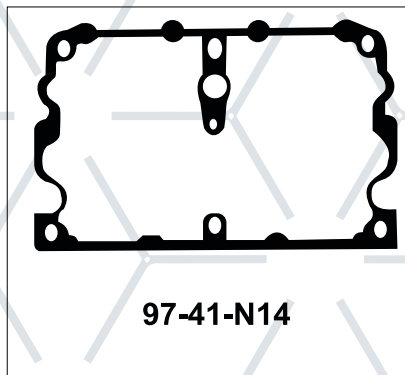
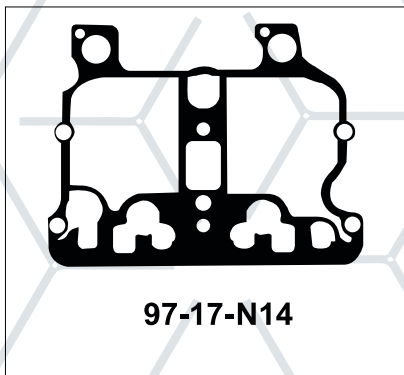
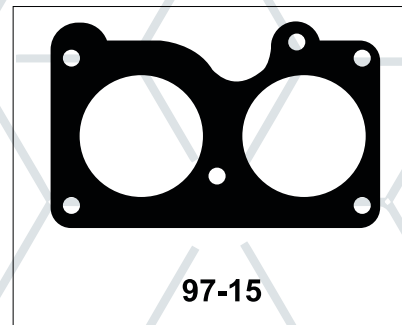
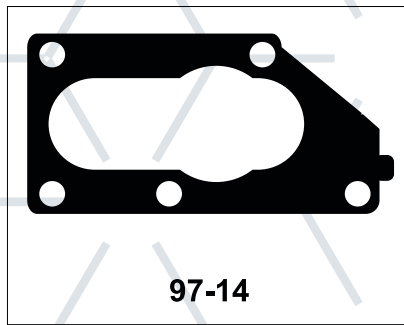
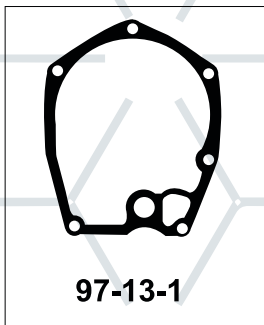
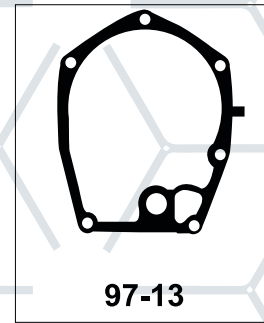
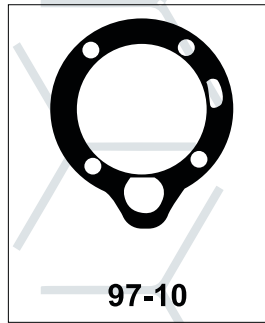
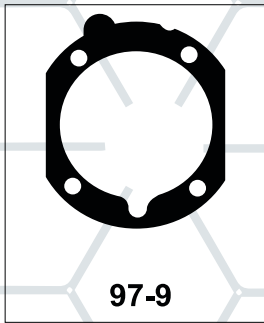

CUMMINS

ORIGINAL	FIRTS	APLICACIÓN
3076228	97-9	Junta Compresor
3076226	97-10	Junta Compresor
3076522	97-13	Junta Bomba de Agua
3068537	97-13-1	Junta Bomba de Agua
3865195	97-14	Junta Termostato
3065236	97-15	Junta Termostato
3076292	97-17-N14	Junta Banco de Balancines
3076284	97-41-N14	Junta Freno de Motor
3066311	PS-907-N14	Junta de Punterías

**ALAR-51477**

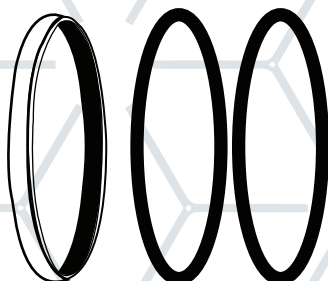

JUEGO DE LIGAS PARA CAMISA DE CILINDROS, MOTOR 350 SMALL CAM,  
BIG CAM I, II, III, BC IV 400 Y N14

CUMMINS

**CJ-KIT-904**

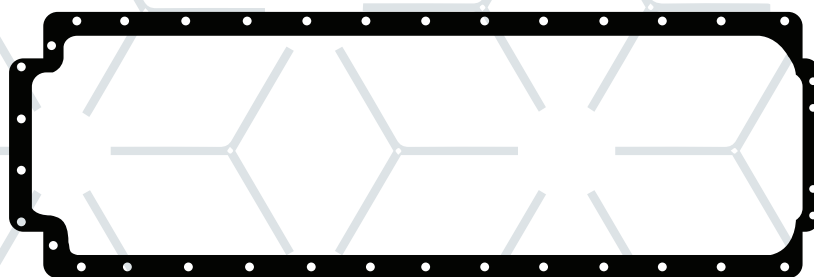

**CJ-904-2**



**94-28**



**ROLDANA**



**SELLO SECCIÓN  
CUADRADA**



**O'RING**

JUEGO DE JUNTAS PARA CÁRTER DE MOTOR CUMMINS SERIE 855 Y N14  
CJ-KIT-904/32 JUNTA CÁRTER EN 0.032" DE ESPESOR  
CJ-KIT-904/16 JUNTA CÁRTER EN 0.062" DE ESPESOR

**VD-012-350**



90-11

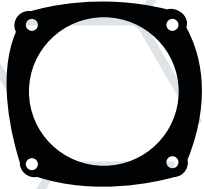

90-18

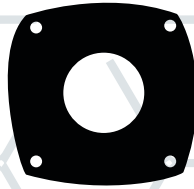

90-19



90-29



94-34

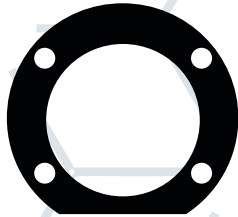

94-7

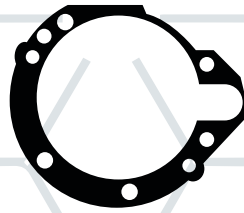

94-12



94-25

JUEGO DE JUNTAS PARA COMPRESOR MOTOR 350 SMALL CAM, BIG CAM I, II, III, IV, 400 Y N14

**VD-015**

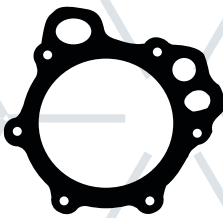

94-34

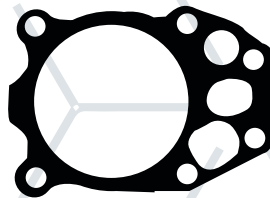

94-35

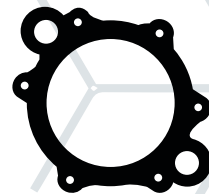

94-38

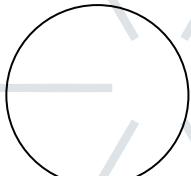

O'RING

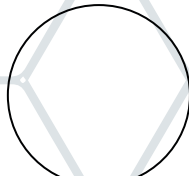

O'RING



ARILLO DE LATON

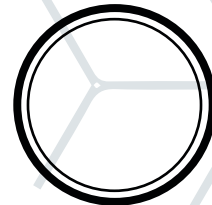

ARILLO DE LATON

JUEGO DE JUNTAS PARA ENFRIADOR DE ACEITE MOTOR 350  
SMALL CAM, BIG CAM I y II

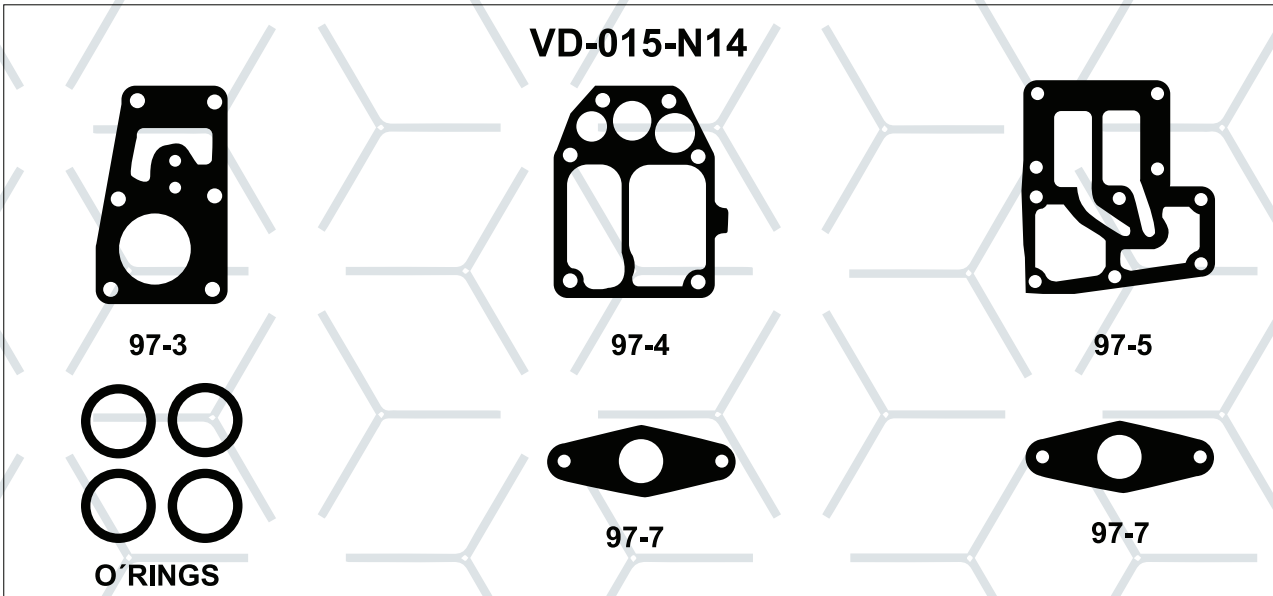

**JUEGO DE JUNTAS PARA ENFRIADOR DE ACEITE MOTOR N14**

**CUMMINS**

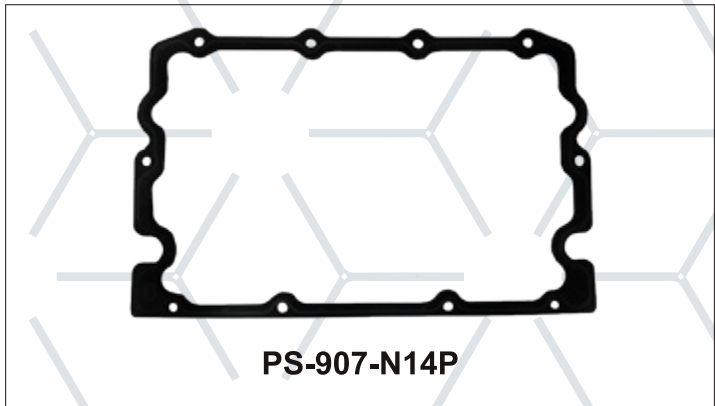

ORIGINAL	FIRTS	APLICACIÓN
3066311	PS-907-N14P	Junta Tapa Puntería N14 Plástico

**COM-VD-016-LA**

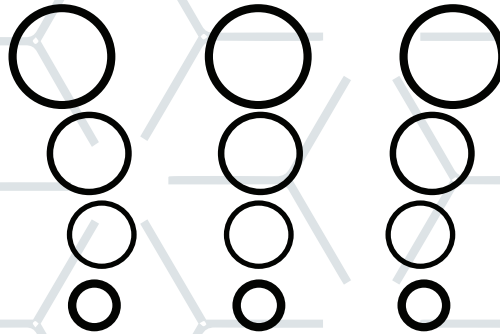

**JUEGO DE LIGAS Y SELLOS FRENO DE MOTOR CUMMINS 350**

**VD-016**

94-41

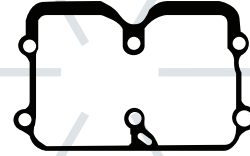
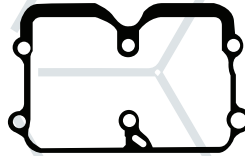
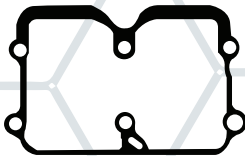

94-30-LA

**SELLOS**

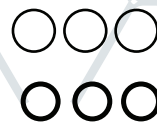
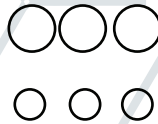

PS-905-LAN

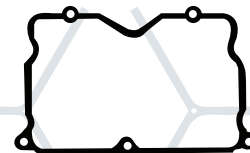

**JUEGO DE JUNTAS PARA ENFRIADOR FRENO DE MOTOR 350**  
 SMALL CAM, BIG CAM, I, II, III, REF.3801640  
 VD-016-LA (JUNATA FRENO DE MOTOR LAMINADA)  
 VD-016 (JUNTA FRENO DE MOTOR EN ASB 1/32)

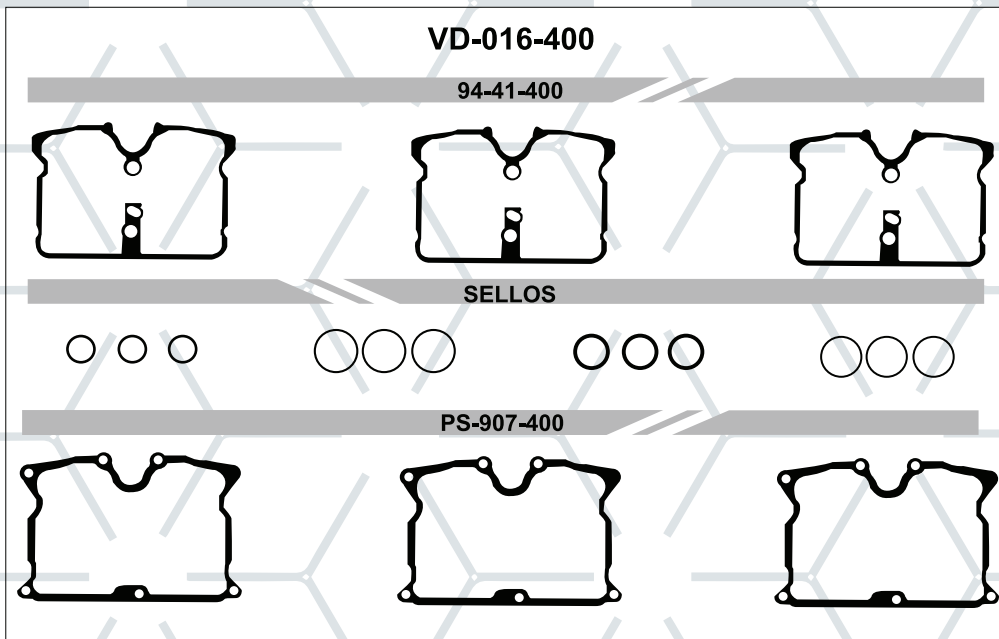

CUMMINS JUEGO DE JUNTAS PARA AFINACIÓN DE FRENO DE MOTOR 400 HP

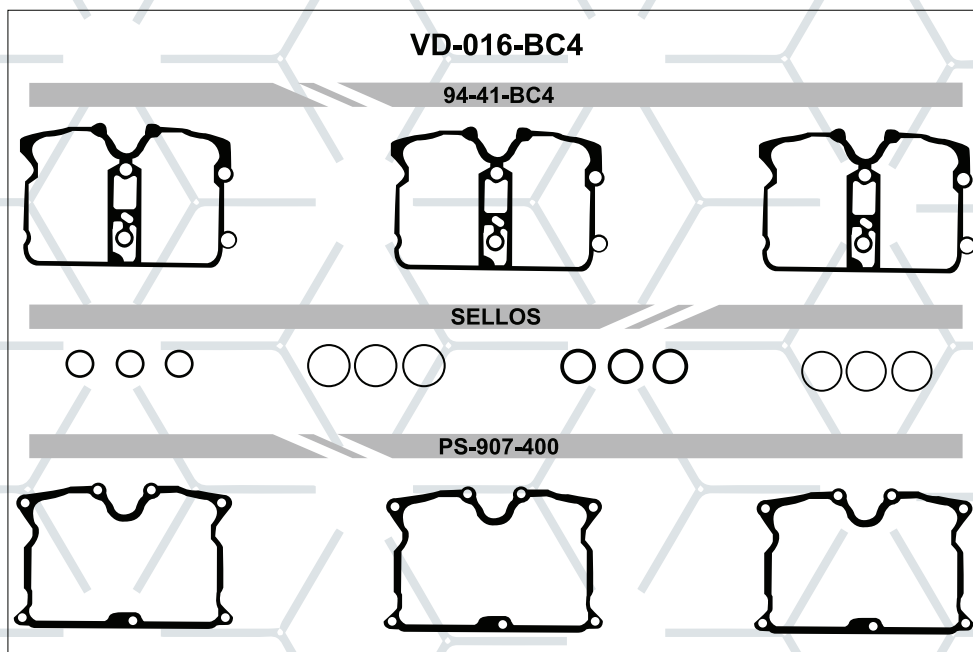

CUMMINS JUEGO DE JUNTAS PARA AFINACIÓN DE FRENO DE MOTOR DE BIG CAM IV

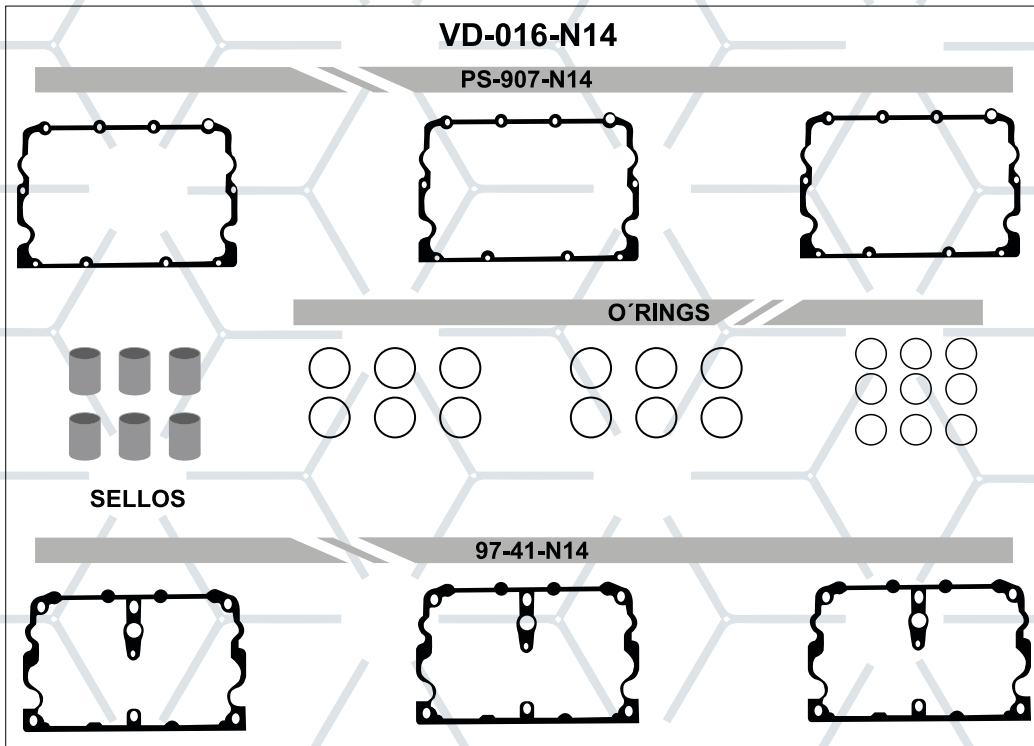

**JUEGO DE JUNTAS PARA AFINACIÓN DE FRENO DE MOTOR CUMMINS N14**



**JUEGO DE JUNTAS PARA ENFRIADOR DE ACEITE DE MOTOR BIG CAM III, IV Y 400**

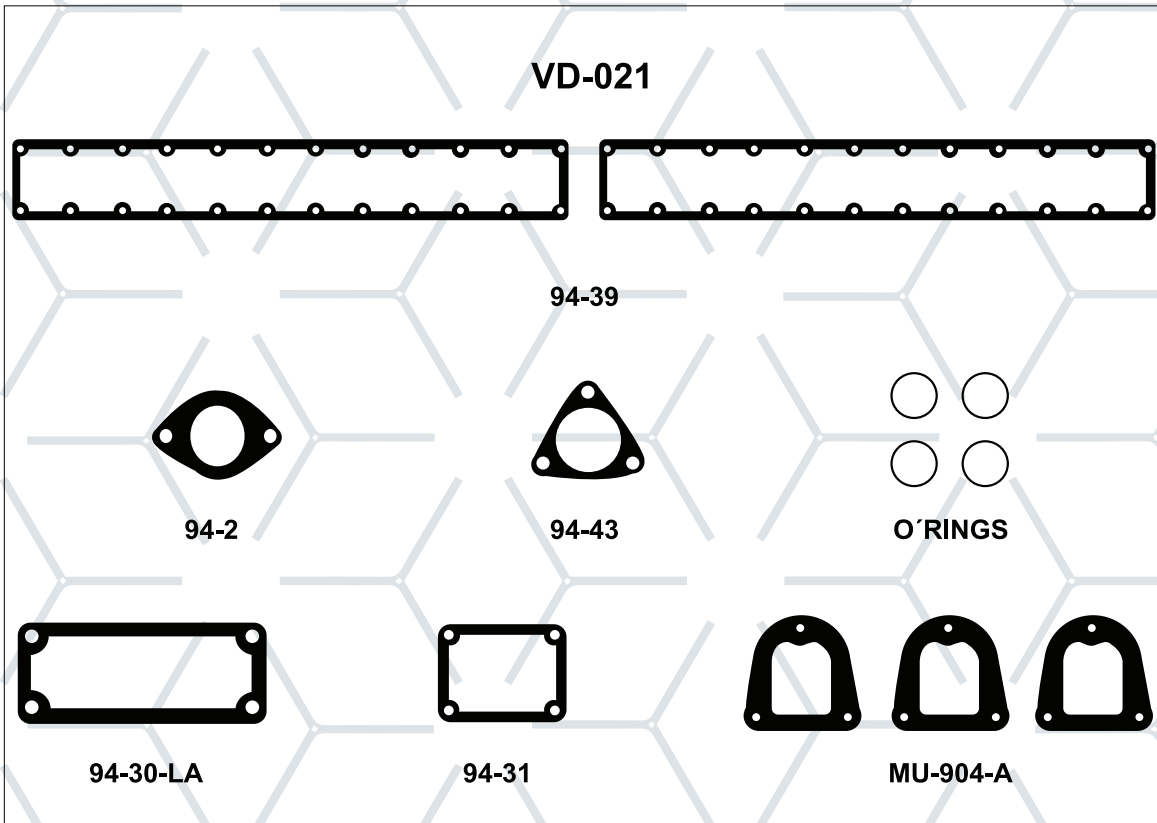

CUMMINS

**JUEGO DE JUNTAS PARA INTERCOOLER MOTOR 350 S.C. BIG CAM I Y II**

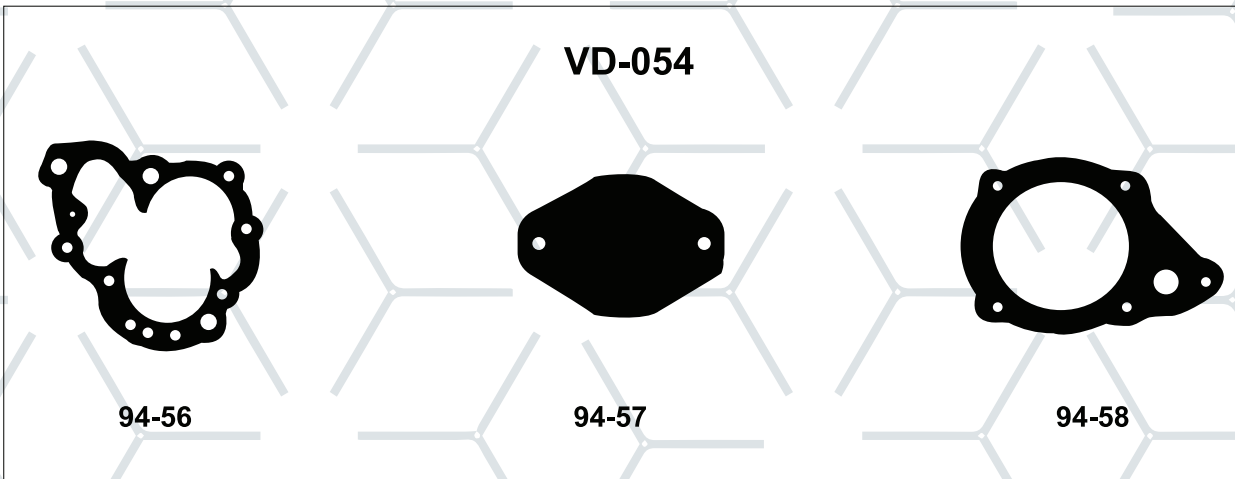

**JUEGO DE JUNTAS PARA BOMBA DE ACEITE MOTOR 350 BIG CAM, III, IV, 400 Y N14**

**VD-054-XAL**



**94-11**



**94-22**

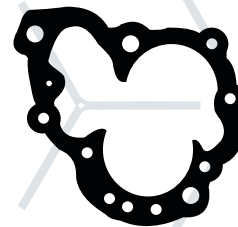

**94-56**



**94-58**



**94-57**



**94-57-XAL**

**JUEGO DE JUNTAS PARA BOMBA DE ACEITE MOTOR 350, BIG CAM I, II, III, IV, 400 Y N14**

**VD-063**



**94-6**

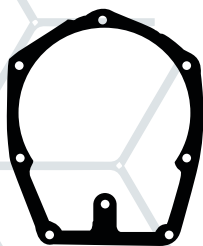

**94-13**



**O'RING**

**JUEGO DE JUNTAS PARA BOMBA DE AGUA MOTOR 350, SMALL CAM, BIG CAM I, II, III, IV, 400**

VD-063-N14

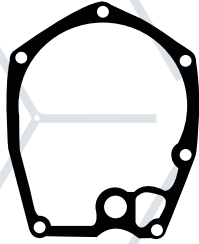

97-13-1

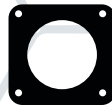

94-6



O´RING

JUEGO DE JUNTAS PARA BOMBA DE AGUA MOTOR N14

VD-063-N14-E

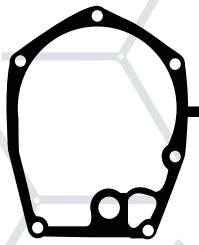

97-13



94-6



O´RING

JUEGO DE JUNTAS PARA BOMBA DE AGUA MOTOR N14 ELECTRÓNICO

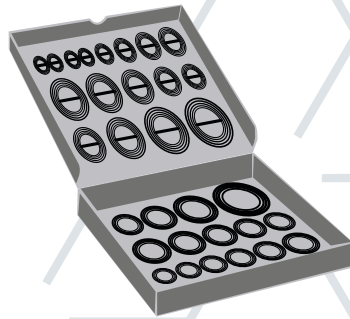

**AS568STA**

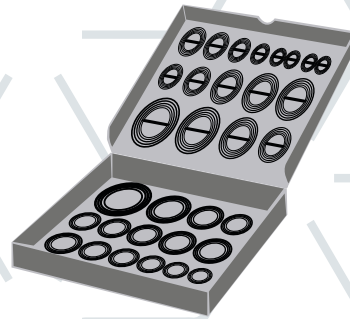

**AS568MM**

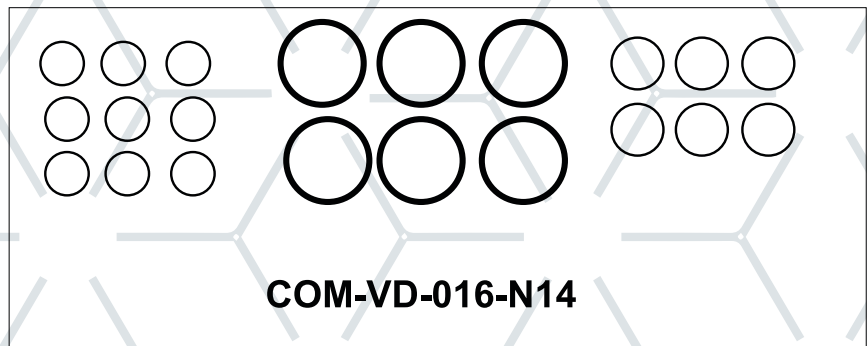
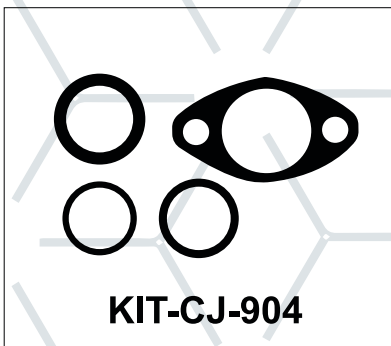

CUMMINS

ORIGINAL	FIRTS	APLICACIÓN
	AS568STA	Estuche de Orings Estándar Importado
	AS568MM	Estuche de Orings Milimétrico Importado
	KIT-CJ-904	Juego de Juntas Succión Cummins 350, N14 BC4
	COM-VD-016-N14	Juego de Sellos Freno de Motor Cummins N 14

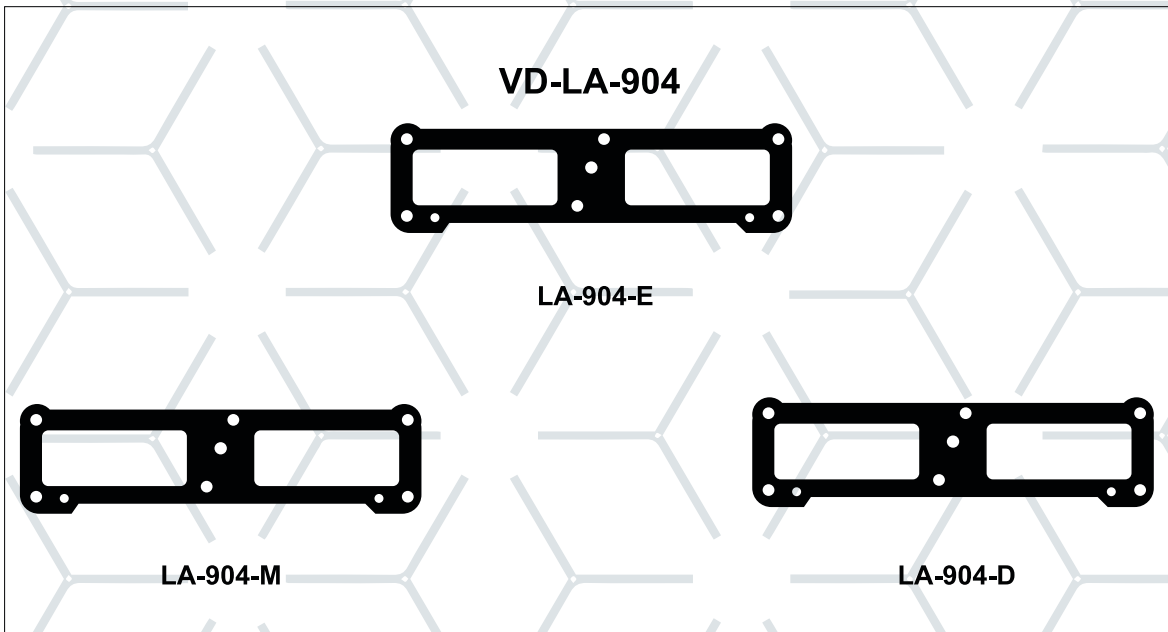

JUEGO DE JUNTAS DE AJUSTE MOTOR 350 SMALL CAM (3 PZAS. DE CADA UNA)

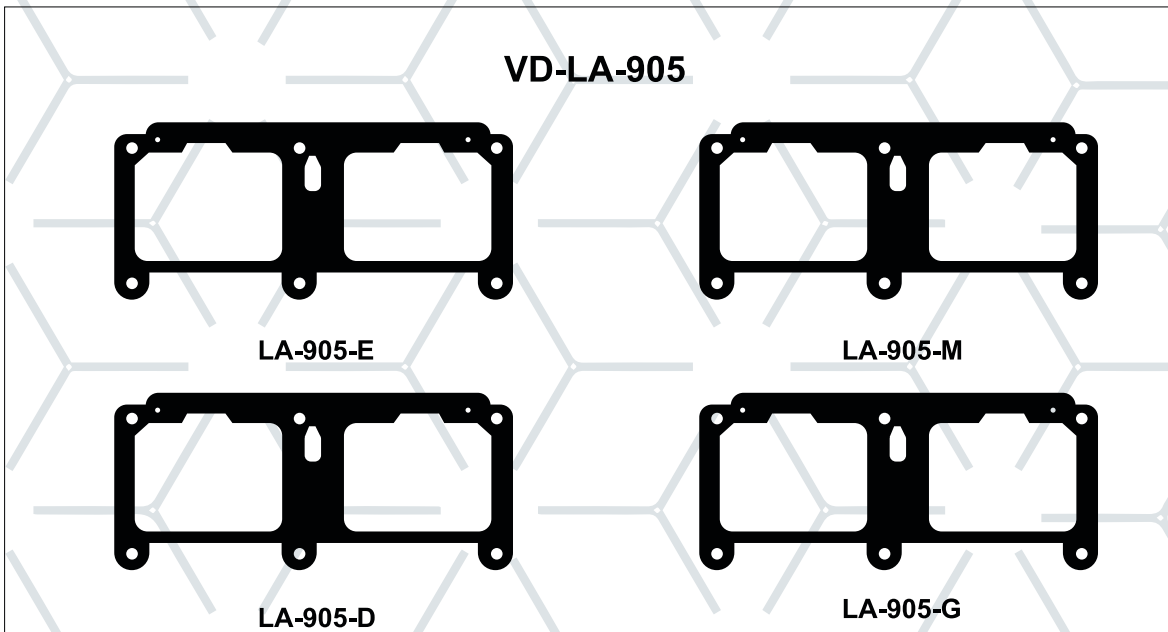

JUEGO DE JUNTAS DE AJUSTE MOTOR 350 BIG CAM, I, II, III, IV Y N14 (3 PZAS. DE CADA UNA)

CUMMINS

CUMMINS

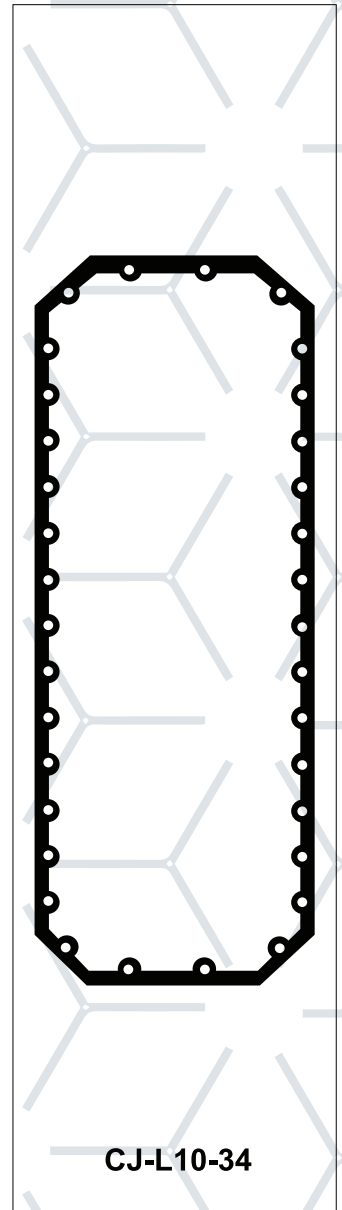
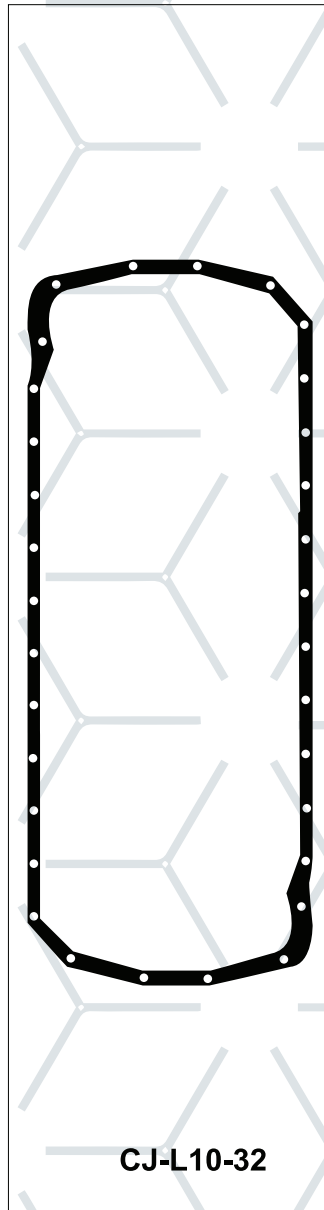
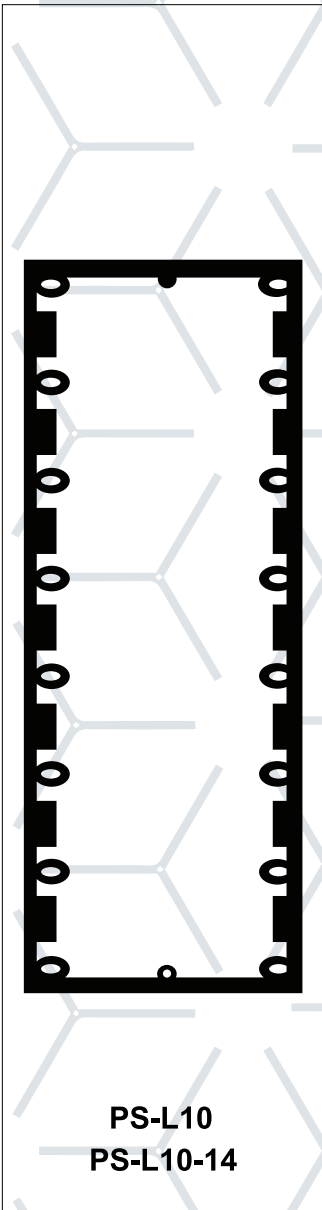

ORIGINAL	FIRTS	APLICACIÓN
AL3883220	PS-L10	Liga Puntería L-10 y M11
AL3034855	PS-L10-14	Liga Tapa Puntería L-10 (14 Orificios)
AL3401290	CJ-L10-32	Junta Cáster Cummins L-10 y M-11 ( 32 Orificios )
AL3882433	CJ-L10-34	Junta Cáster Cummins L-10 ( 34 Orificios)

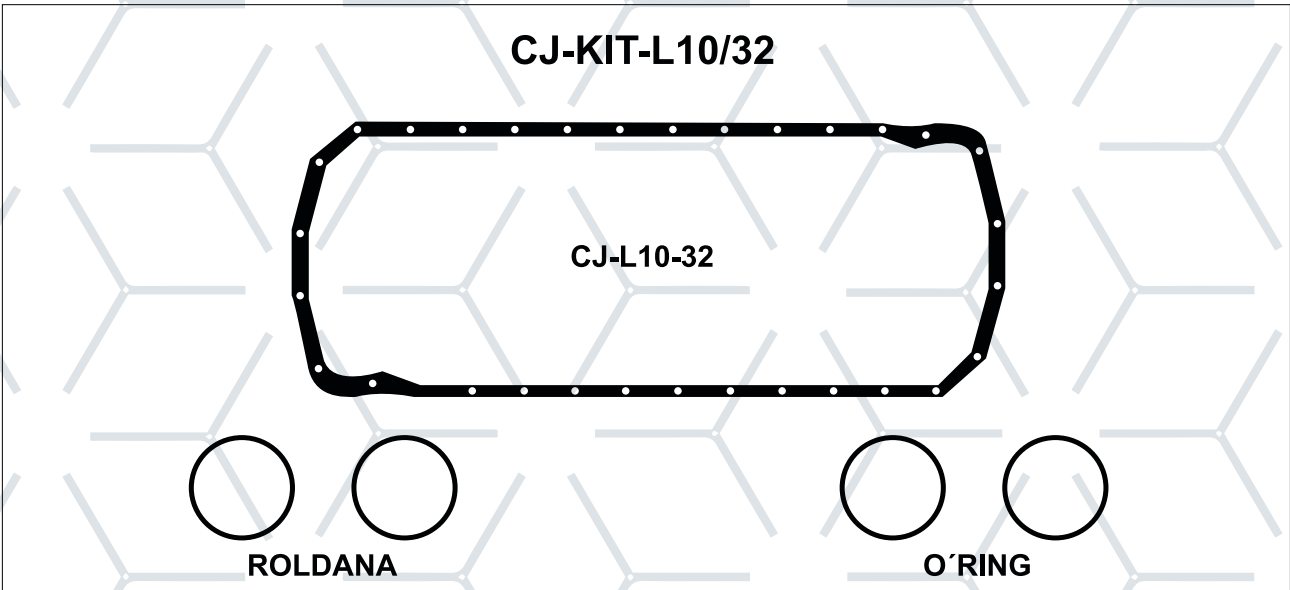

JUEGO DE JUNTAS PARA CÁRTER CUMMINS L-10 Y M11 ( 32 ORIFICIOS )

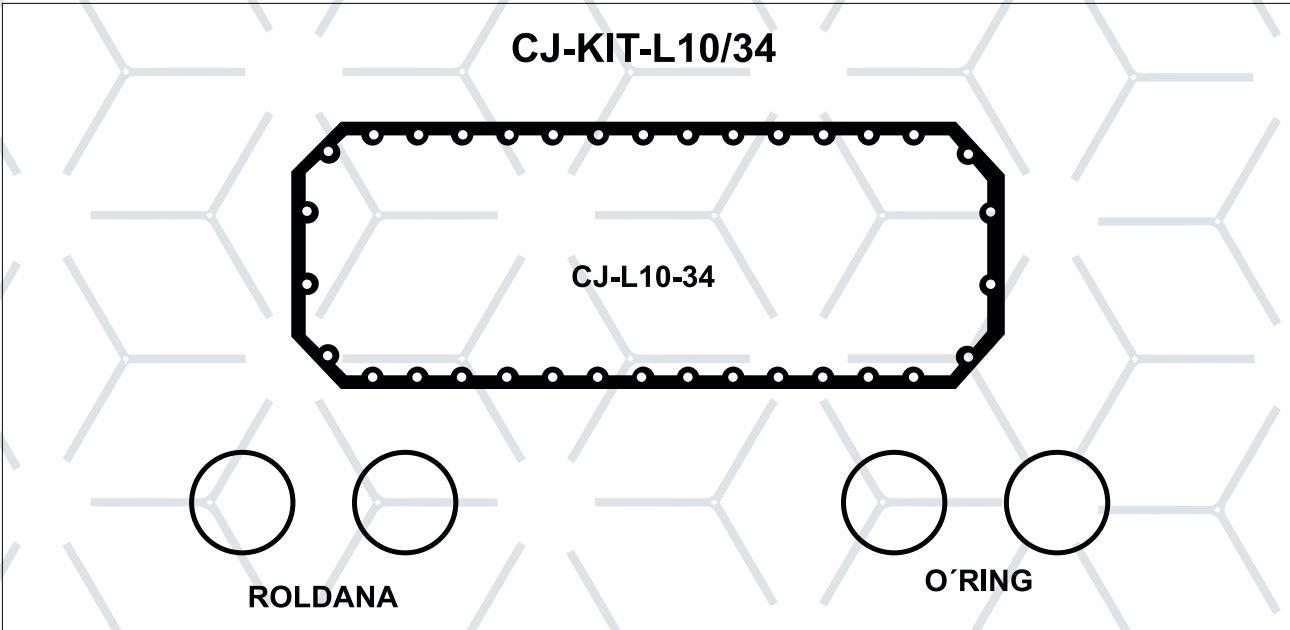

JUEGO DE JUNTAS PARA CÁRTER CUMMINS L-10 ( 34 ORIFICIOS )

CUMMINS

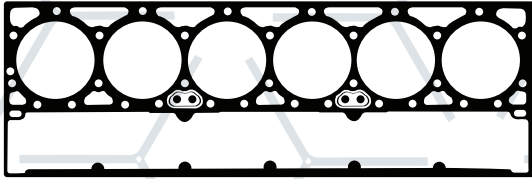

CA-L10

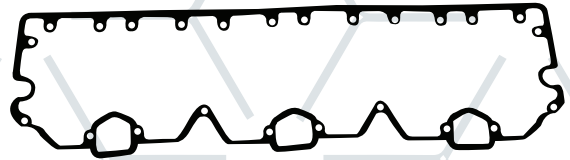

L10-1-LA

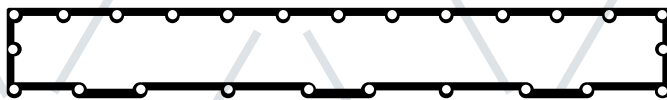

L10-2

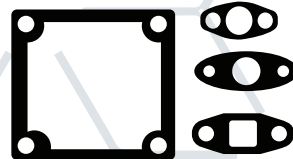

L10-3



L10-4

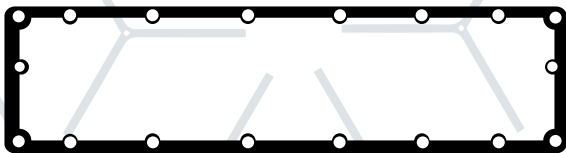

L10-5



DIS-L10/M11

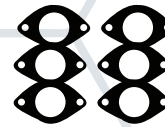

MU-L10-E



ES-L10-T

CUMMINS

ORIGINAL	FIRTS	APLICACIÓN
	CA-L10	Junta de Cabeza L10E M11
4070529	L10-1-LA	Junta Banco de Balancines L-10 Laminada
3818843	L10-2	Junta Lateral L10
	L10-3	Juntas Entrada del Turbo L-10, M-11
	L10-4	Juntas Salida del Turbo L-10, M-11
3883220	L10-5	Junta Freno de Motor L-10E, M-11
4920751	DIS-L10/M11	Liga Tapa de distribución L10-M11
3819760	MU-L10-E	Juego de Juntas de Múltiples Escape L-10
	ES-L10-T	Junta Turbocargador L10

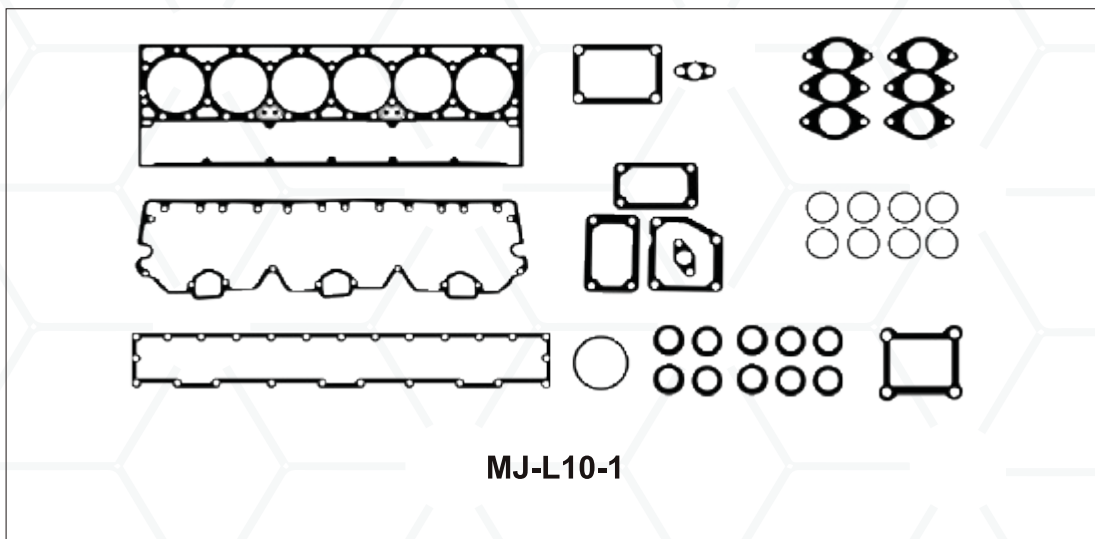
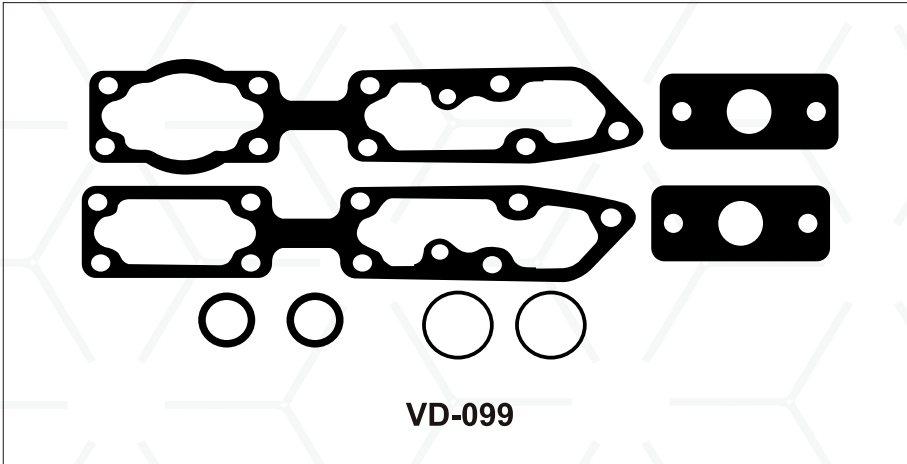

ORIGINAL	FIRTS	APLICACIÓN
	VD-099	Juntas para enfriador aceite L10-E,M11, L10
	MJ-L10-1	Medio Juego superior CUMMINS L10 - M11
3899798	FTPS-M11	Goma Puntería ISM-M11

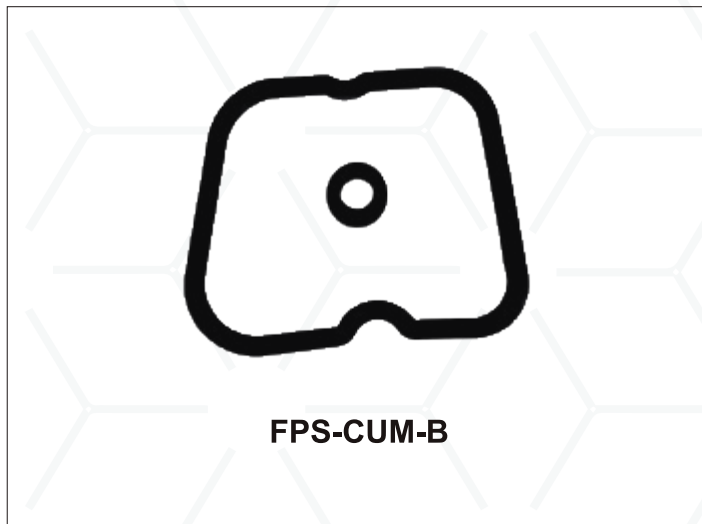

ORIGINAL

FIRTS  
FPS-CUM-B

APLICACIÓN  
Liga Tapa de Punterias

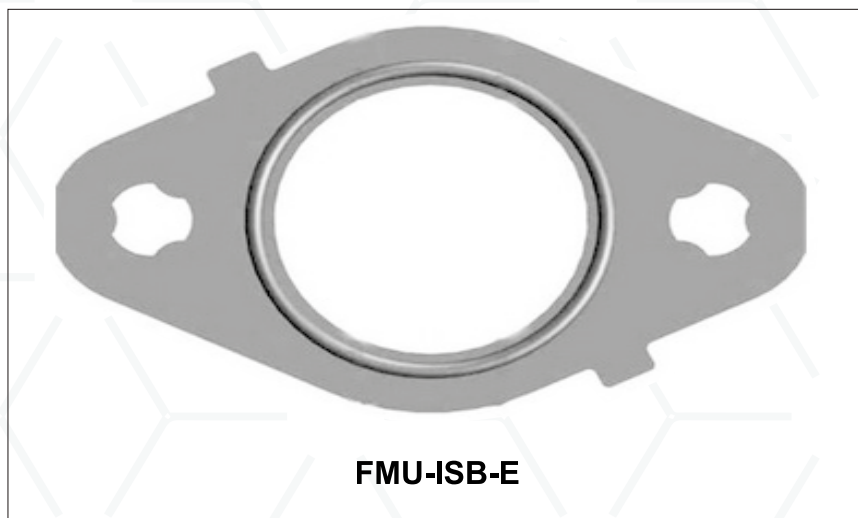
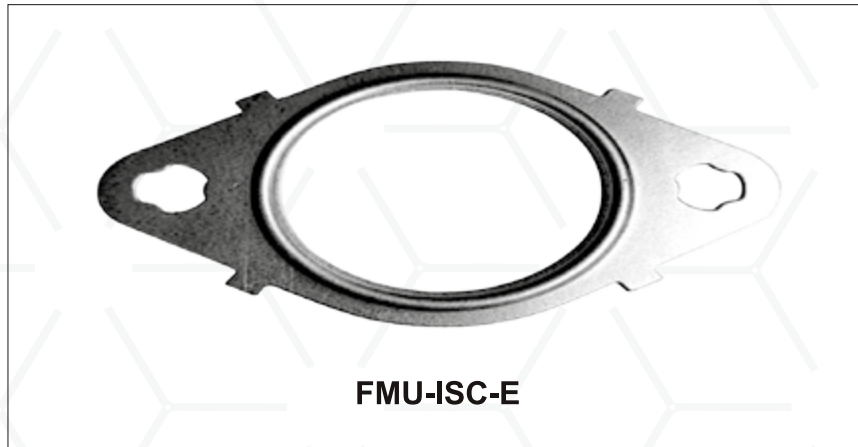

ORIGINAL	FIRTS	APLICACIÓN
3678770	FMU-ISC-E	Junta escape CUMMINS ISC
3946275	FMU-ISB-E	Junta escape ISB Electronico

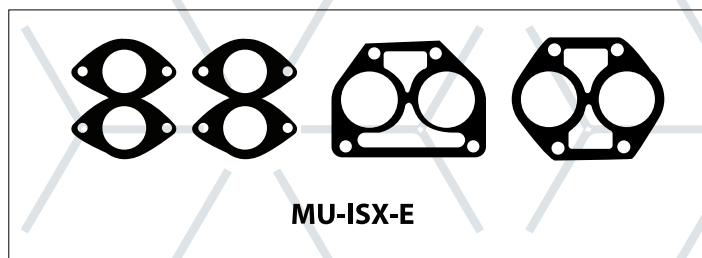
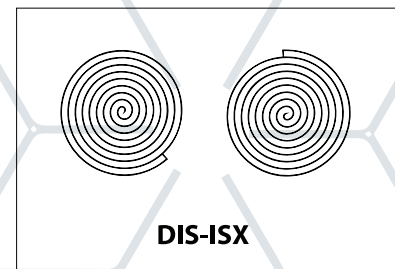
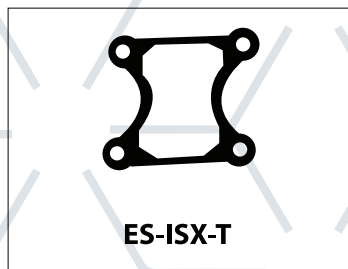
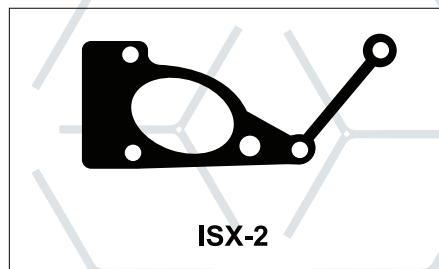
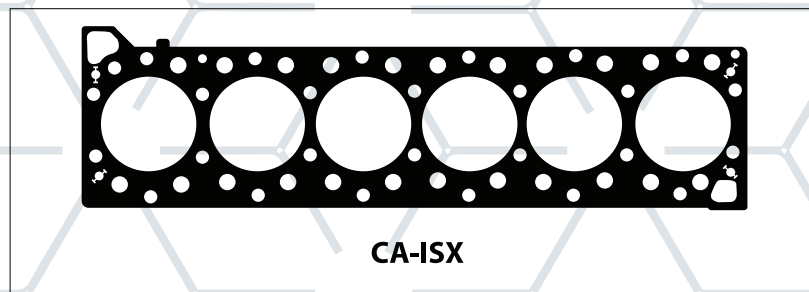
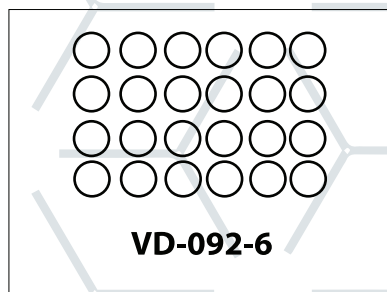
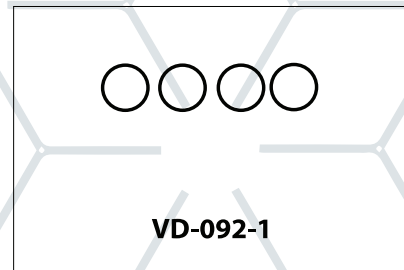
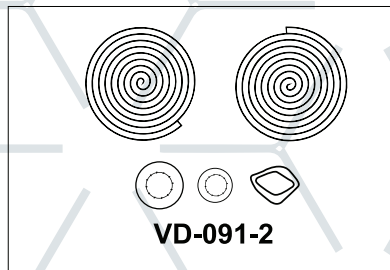
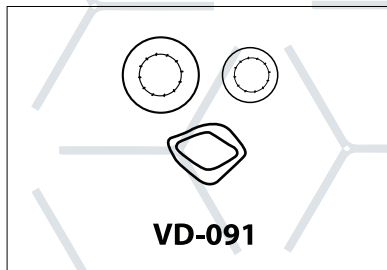

**CUMMINS**

ORIGINAL	FIRTS	APLICACIÓN
	VD-091	Juego de Ligas de Árbol de Levas ISX
	VD-091-2	Juego de Ligas de Árbol de Levas y Distribución ISX
	VD-092-1	Juego de Ligas para Un Inyector ISX
	VD-092-6	Juego de Ligas para Seis inyectores ISX
	CA-ISX	Junta de Cabeza Cummins ISX
	ISX-2	Junta Conexión ISX
3080465	ES-ISX-T	Junta Turbocargador ISX
	DIS-ISX	Juego de Ligas de Distribución ISX
	MU-ISX-E	Juego de Juntas de Múltiples Escape ISX



**FMU-ISX-A**



**FISX-6-LA**



**FISX-7-LA**

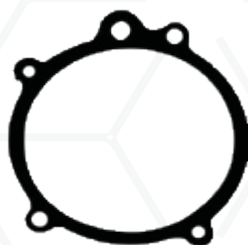

**FISX-8-LA**

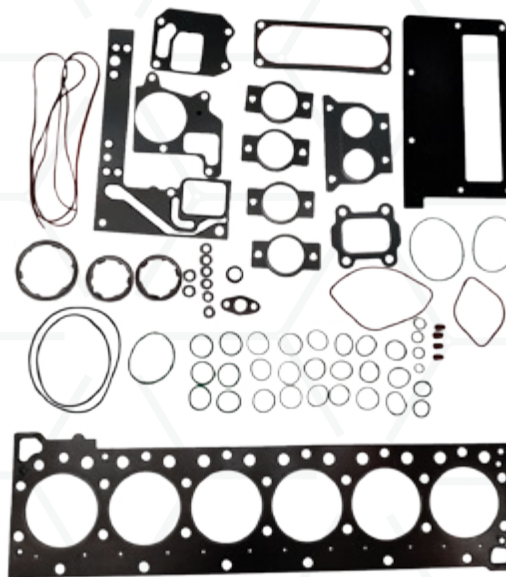

**MJ-ISX-1EGR**

ORIGINAL	FIRTS	APLICACIÓN
3678770	FMU-ISX-A	Junta múltiple admisión Cummins ISX
3682673	FISX-6-LA	Junta base del filtro Cummins ISX
3680602	FISX-7-LA	Junta termostato Cummins ISX
4965690	FISX-8-LA	Junta compresor Cummins ISX
	MJ-ISX-1EGR	Medio juego superior Cummins ISX EGR

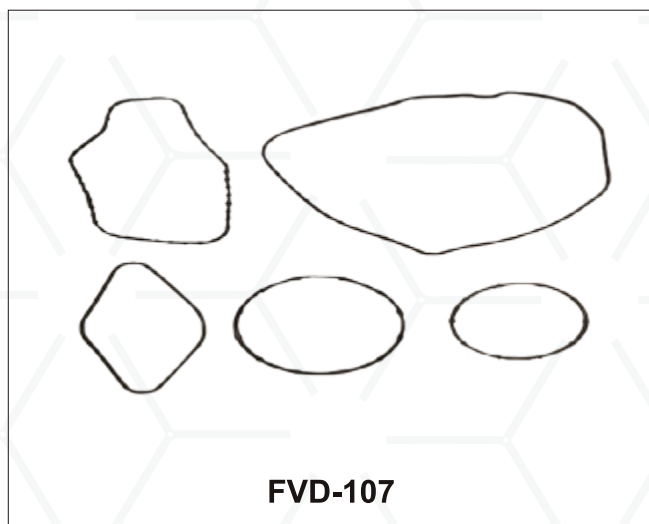
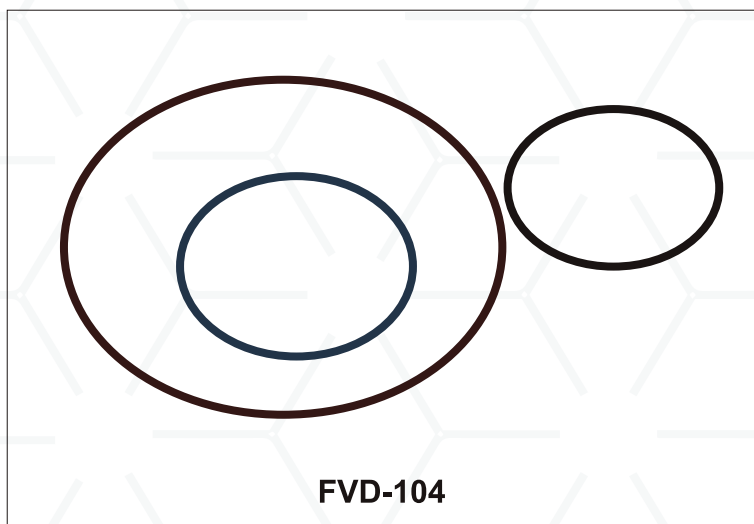
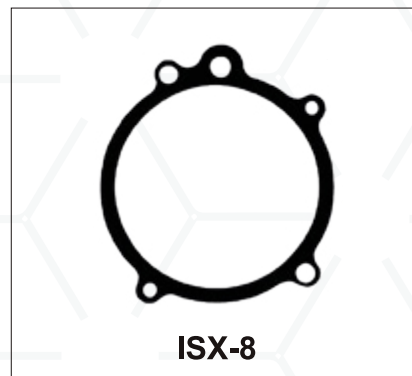
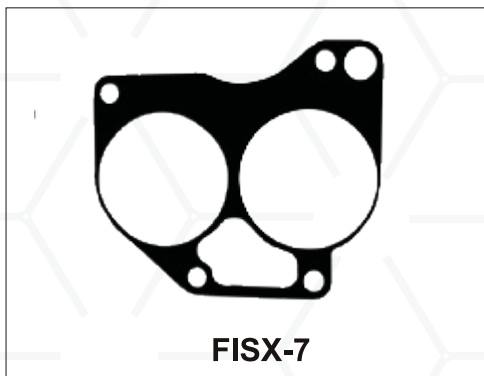
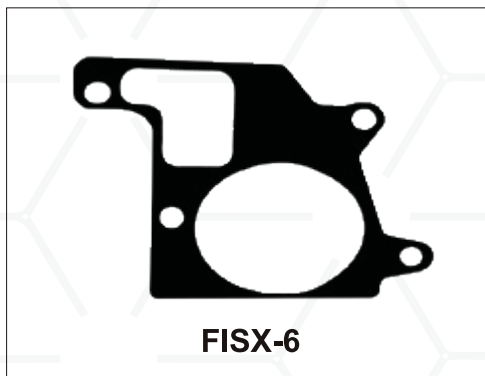

ORIGINAL	FIRTS	APLICACIÓN
3682673	FISX-6	Junta base filtro ISX
3680602	FISX-7	Junta termostato ISX
	ISX-8	Junta Compresor
	FVD-104	Juego de Ligas Bomba Agua ISX
	FVD-107	Juego de Ligas árbol levas CUMMINS ISX 15



FPS-ISX

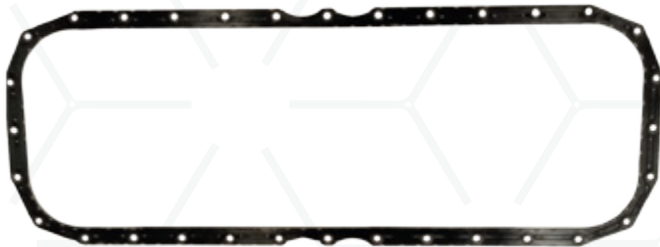

FCJ-ISX

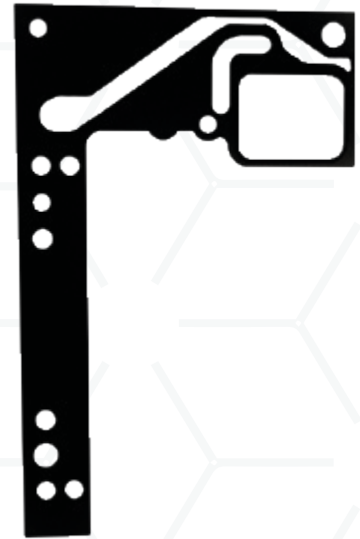

FISX-9

ORIGINAL	FIRTS	APLICACIÓN
4026507	FPS-ISX	Junta Punterías CUMMINS ISX
4026684	FCJ-ISX	Junta de Carter CUMMINS ISX
4965689	FISX-9	Junta de Combustible caja CUMMINS ISX



FR-ISX-1



FR-ISX-2



FR-ISX-3

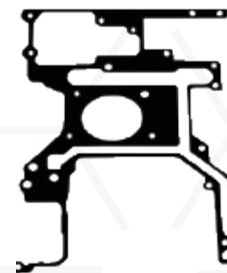

FDT-ISX-15



FISX-10



FISX-11

ORIGINAL	FIRTS	APLICACIÓN
3963983	FR-ISX-1	Arandela Sello Línea Diesel ISX
4934278	FR-ISX-2	Arandela Tornillo Banjo VGT ISX
3684284	FR-ISX-3	Arandela Tornillo Tubo Turbo ISX EGR
4393089	FDT-ISX-15	Junta Tapa distribución Cummins ISX 15
3683695	FISX-10	Goma Respirador Tapa Dist ISX
3683670	FISX-11	Goma Respirador Tapa Dist ISX EGR

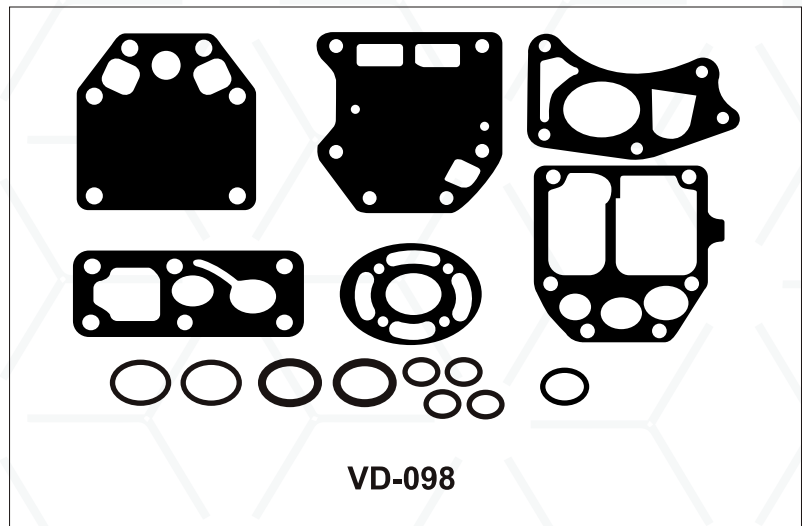
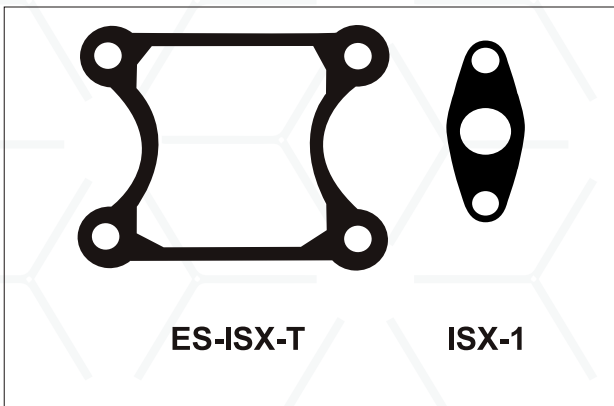
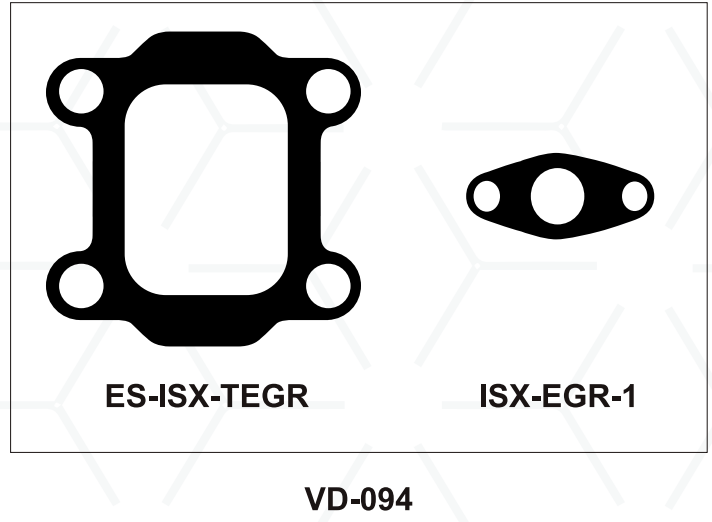
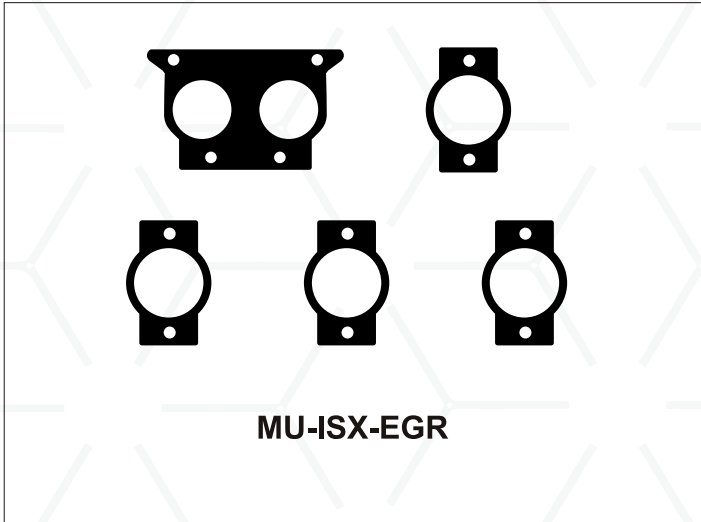

ORIGINAL	FIRTS	APLICACIÓN
	MU-ISX-EGR	Juego de juntas escape ISX Valvula EGR
	VD-094	Juego de juntas montaje de Turbo ISX EGR
	ES-ISX-TEGR	Junta de turbo ISX Valvula EGR
	ISX-EGR-1	Junta descarga aceite de Turbo ISX EGR
	VD-095	Juego de juntas montaje de Turbo ISX
	ES-ISX-T	Junta de Turbo ISX
	ISX-1	Junta descarga aceite de Turbo ISX
3803068	VD-098	Juntas para enfriador aceite Big Cam IV

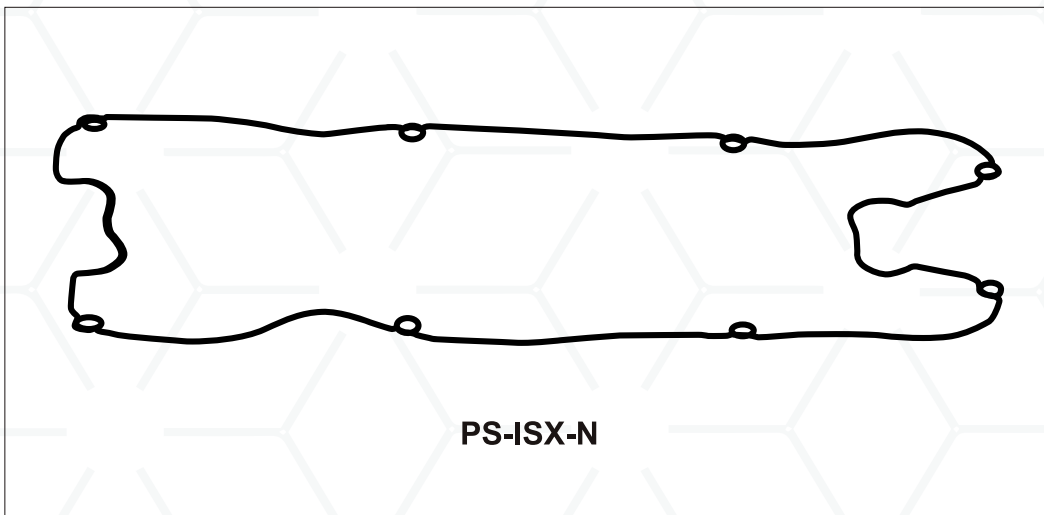

PS-ISX-N



FTPS-ISX

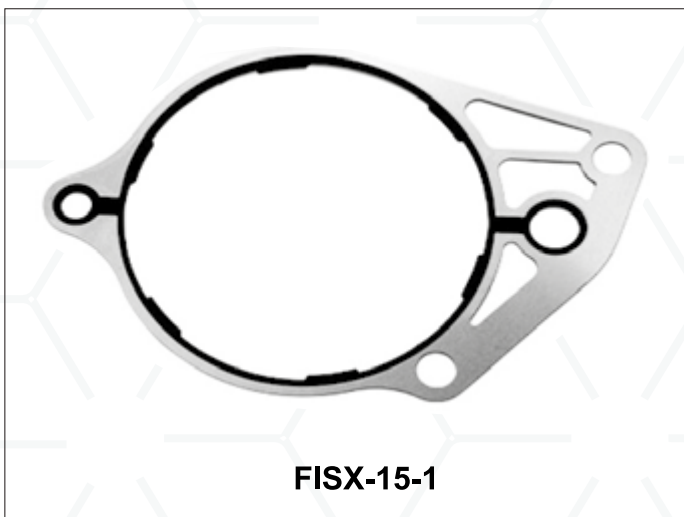

FISX-15-1

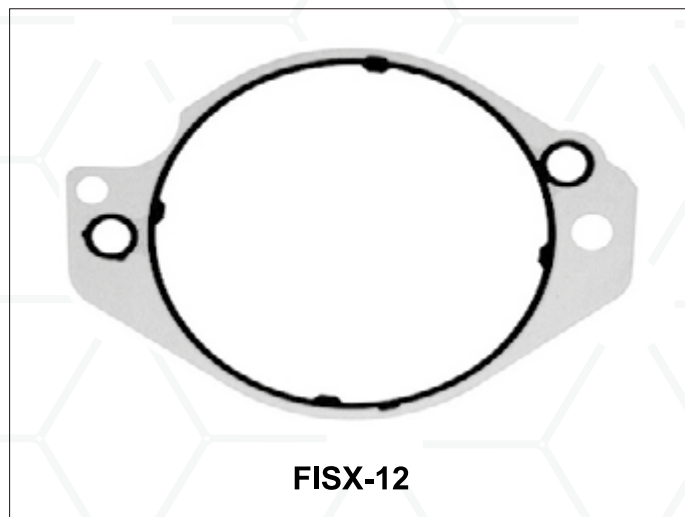

FISX-12

ORIGINAL	FIRTS	APLICACIÓN
3104392	PS-ISX-N	Liga de punterías ISX Diseño Nuevo
3104389	FTPS-ISX	Goma Tornillo Puntería ISX
3386758	FISX-15-1	Junta Bomba de Combustible
3685614	FISX-12	Junta de Montaje del Compresor

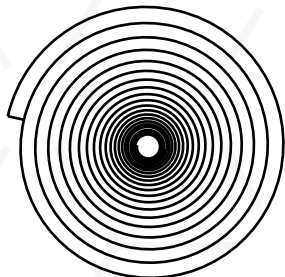

DIS-ISX-N

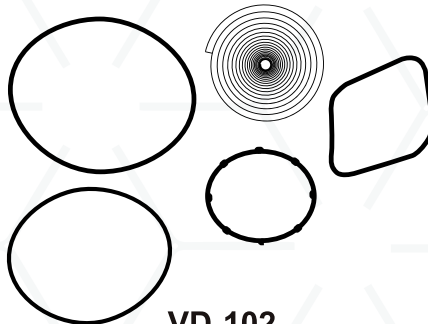

VD-102

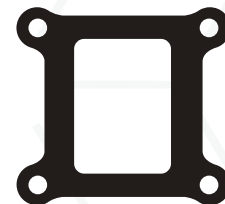

ES-ISMM11-T

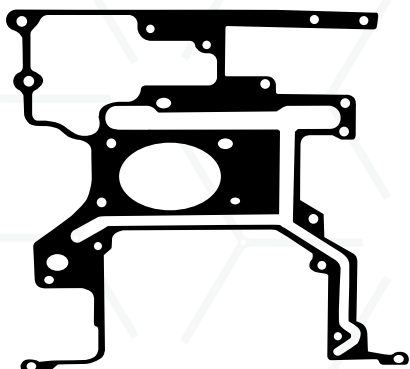

DT-ISX

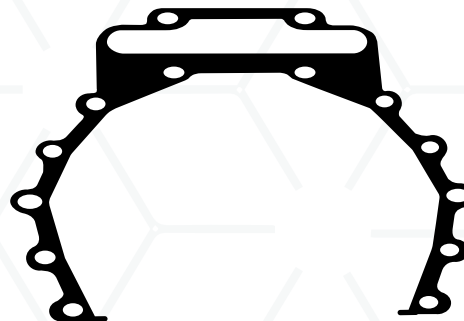

ISX-4

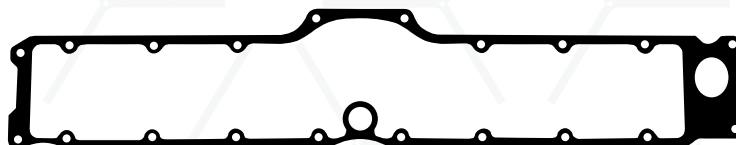

ISX-5

ORIGINAL	FIRTS	APLICACIÓN
3687007	DIS-ISX-N	Liga de distribución ISX NUEVO
	VD-102	Juego de ligas distribución y arbol de levas ISX NUEVO
3084884	ES-ISMM11-T	Junta de Turbo ISM y M11
4985562	DT-ISX	Junta distribucion ISX
4965688	ISX-4	Junta brida sigueñan carcasa ISX
3689755	ISX-5	Junta enfriador ISX





# NAVISTAR®

## NAVISTAR

### NAVISTAR DT-360 Y DT 466

JUEGO DE JUNTAS ..... 67

PIEZAS SUELTAS ..... 70

### NAVISTAR DT 466 NGD (MECÁNICO Y ELECTRICO)

JUEGO DE JUNTAS ..... 74

PIEZAS SUELTAS ..... 75

### VARIOS DIESEL ..... 77

VD-065            Juegos de Ligas para Distribución Navistar NGD DT-466

VD-066            Juego de Juntas para Montaje del Turbo Navistar DT-466, DT-408, NGD DT-466

VD-067            Juego de Ligas para Enfriador de Aceite Motor NGD DT-466, DT-408, 530

VD-068            Juego de Ligas para Distribución Navistar NGD DT-466 (Electrónico)

VD-069-6        Kit de Afinación para 6 Inyectores Navistar NGD ( Electrónico )

VD-069-1        Kit de Afinación para 1 Inyector Navistar NGD ( Electrónico )

VD-070            Juego de Juntas para Enfriador de Aceite DT-360 y DT-466 (hasta 1993)



**DT-360, DT- 466 NGD MECÁNICO Y ELECTRÓNICO**

NAVISTAR	FIRTS	APLICACIÓN
AL18008973 C93	MJ-2104-1	Medio Juego Superior Navistar DT-466 185-210 HP
AL674399 C96	MJ-2104-2	Medio Juego Inferior Navistar DT-466 185-210 HP
AL1810036 C95	MJ-2105-1	Medio Juego Superior Navistar DT-360 170 HP
AL674399 C96	MJ-2105-2	Medio Juego Inferior Navistar DT-360 170 HP
AL1824970 C98	MJ-2106-1E	Medio Juego Superior Motor Navistar 466 Electrónico
AL1822328 C95	MJ-2106-1M	Medio Juego Superior Motor Navistar 466 Mecánico
	MJ-2106-2E	Medio Juego Inferior Navistar NGD Electrónico
	MJ-2106-2M	Medio Juego Inferior Navistar NGD Mecánico

NAVISTAR

**MJ-2105-1  
AL1810036C95  
JUEGO SUPERIOR NAVISTAR DT-360**

Original	Firts	Cantidad
670079C2	214-3	1
253660R2	214-4	1
675384C2	214-5	1
1809961C2	CA-2105	1
670073C2	ES-2104-T	1
682198C2	MU-2105-A	1
1810169C2	MU-2105-E	1
675389C1	PS-2105	1
675447C1	ROLDANA	6
677692C1	ROLDANA	6
682810C1	SELLO	6
681234C1	SELLO	12

**MJ-2105-2  
AL674399C96  
JUEGO INFERIOR NAVISTAR DT-360**

Original	Firts	Cantidad
675808C2	214-7	1
675816C2	214-8	1
675398C2	214-9	1
675609C2	214-10	1
676988C2	214-11	1
683791C2	214-12	1
675813C2	214-13	1
675812C2	214-14	1
671821C2	214-16	1
1802867C2	214-17	1
	214-18	1
682945C3	214-19	1
675513C1	214-20	2
1810699C4	214-21	1
1910510C3	214-22	1
671825C4	CJ-2105	1
	O'RING	1
	O'RING	1
	O'RING	1
	O'RING	4
	O'RING	2
	ROLDANA	1
	ROLDANA	1

MJ-2104-1 AL1808973C93 JUEGO SUPERIOR NAVISTAR DT-466			MJ-2104-2 AL674399C96 JUEGO INFERIOR NAVISTAR DT-466		
Original	Firts	Cantidad	Original	Firts	Cantidad
686181C2	214-1	1	675808C2	214-7	1
673341C2	214-2	1	675816C2	214-8	1
670079C2	214-3	1	675398C2	214-9	1
253660R2	214-4	1	675609C2	214-10	1
675384C2	214-5	1	676988C2	214-11	1
673973C4	214-6	1	683791C2	214-12	1
1806226C3	CA-2104	1	675813C2	214-13	1
670073C2	ES-2104-T	1	675812C2	214-14	1
	JUNTA	1	671821C2	214-16	1
682199C2	MU-2104-A	1	1802867C2	214-17	1
1809784C1	MU-2104-E	6		214-18	1
675109C3	PS-2104	1	682945C3	214-19	1
675477C1	ROLDANA	6	675513C1	214-20	2
677692C1	ROLDANA	6	1810699C4	214-21	1
681234C1	SELLO	12	1810510C3	214-22	1
682810C1	SELLO	1	671827C2	CJ-2104	1
				O'RING	1
				O'RING	1
				O'RING	1
				O'RING	4
				O'RING	2
				ROLDANA	1
				ROLDANA	1

**NAVISTAR**

**MOTORES DT-360 Y DT-466**

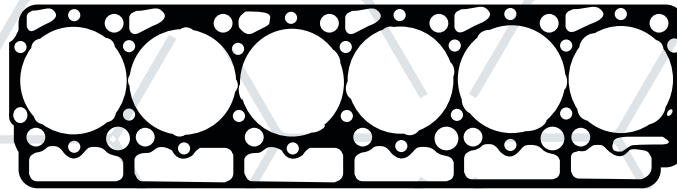

CA-2104

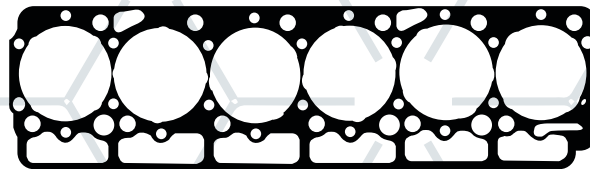

CA-2105



PS-2104



PS-2105

NAVISTAR

ORIGINAL	FIRTS	APLICACIÓN
1806226C3	CA-2104	Junta de Cabeza para Motor NAVISTAR DT-466
1809967C2	CA-2105	Junta de Cabeza para Motor NAVISTAR DT-360
675109C3	PS-2104	Junta Tapa de Punterías para Motor NAVISTAR DT-466 (Corcho)
	PS-2104-H	Junta Tapa de Punterías para Motor NAVISTAR DT-466 (Hule)
675389C1	PS-2105	Junta Tapa de Punterías para Motor NAVISTAR DT-360 (Corcho)
	PS-2105-H	Junta Tapa de Punterías para Motor NAVISTAR DT-360 (Hule)

**MOTORES DT-360 Y DT-466**

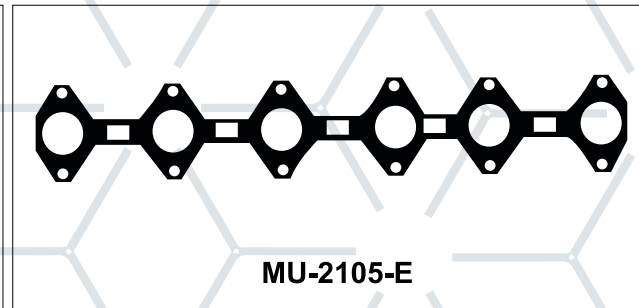
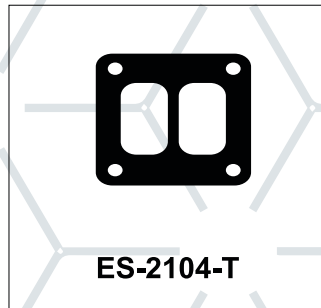
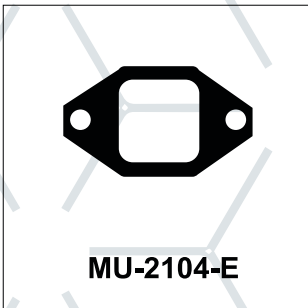
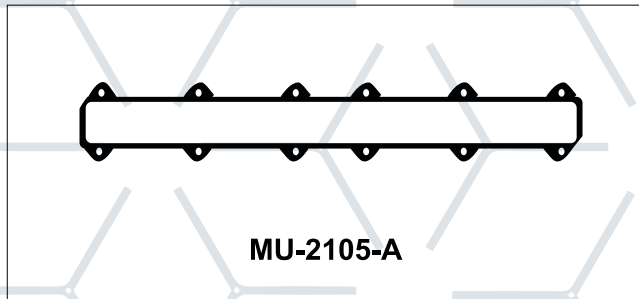
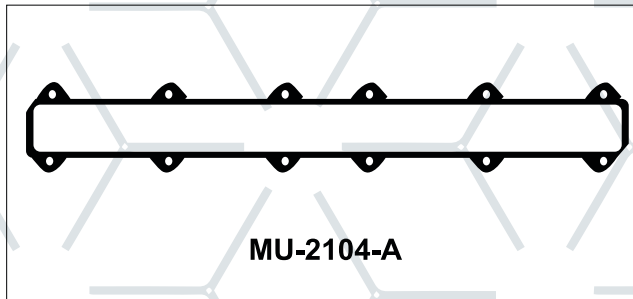
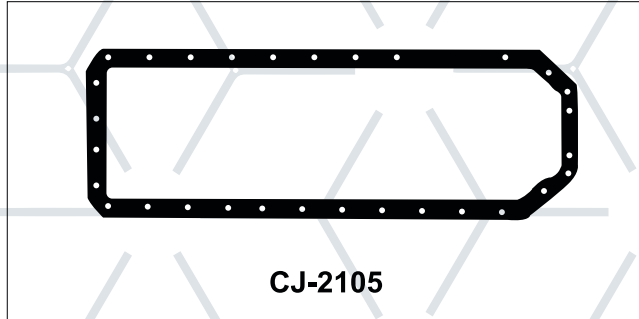
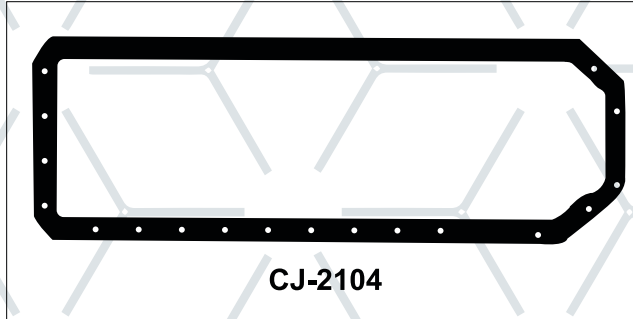

**NAVISTAR**

ORIGINAL	FIRTS	APLICACIÓN
671827C2	CJ-2104	Junta Cárter para Motor NAVISTAR DT-466
671825C4	CJ-2105	Junta Cárter para Motor NAVISTAR DT-360
682199C2	MU-2104-A	Junta Múltiple de Admisión Motor NAVISTAR DT-466
682196C2	MU-2105-A	Junta Múltiple de Admisión Motor NAVISTAR DT-360
1809784C1	MU-2104-E	Juntas Múltiple Escape Motor NAVISTAR DT-466
1810169C2	MU-2105-E	Junta Múltiple Escape Motor DT-360
670073C2	ES-2104-T	Junta Turbocargador Motor DT-360 y DT-466

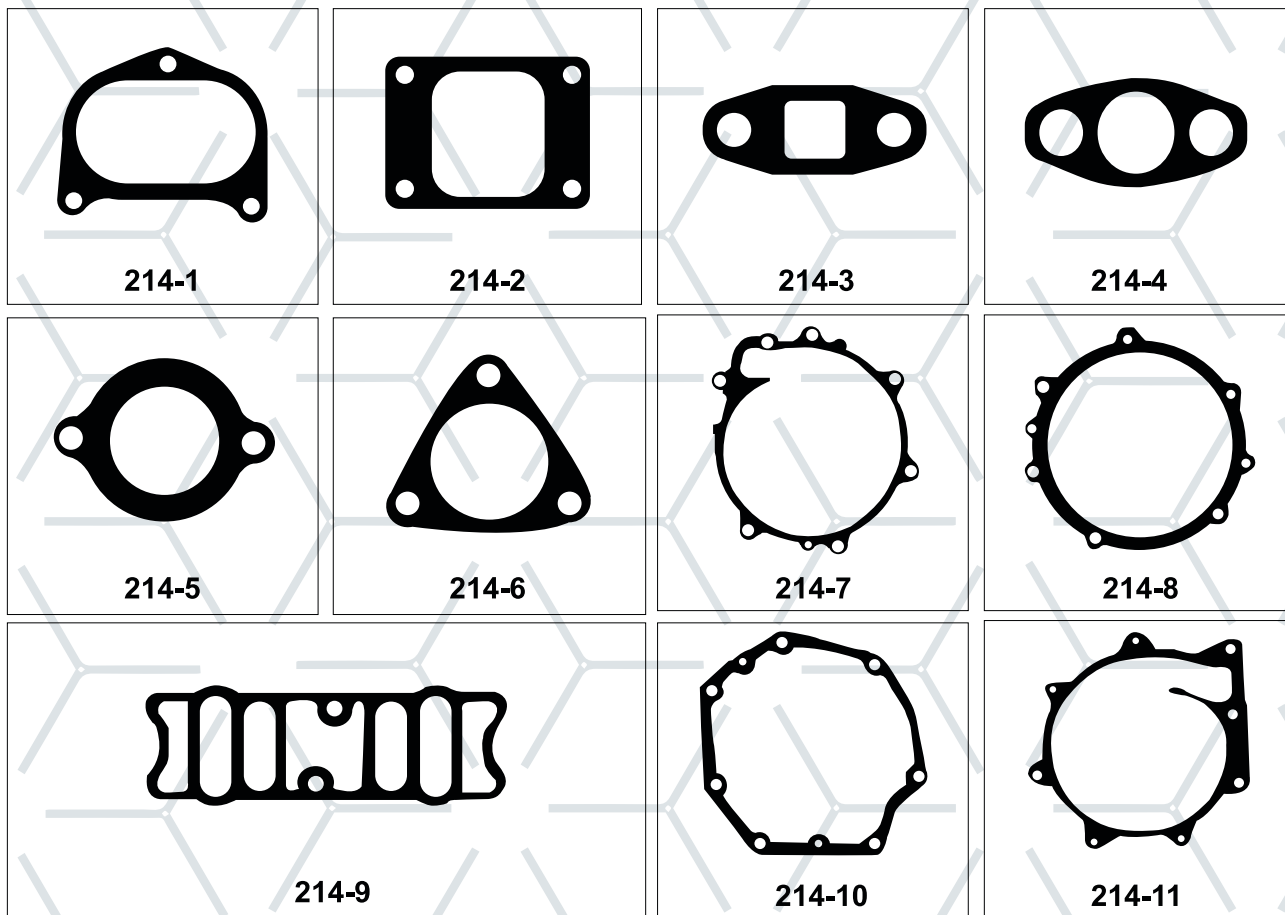
**MOTORES DT-360 Y DT-466**

NAVISTAR

ORIGINAL	FIRTS	APLICACIÓN
686181C2	214-1	Junta Codo Intercambiador de Calor Serie 143536 Motor DT-466
673341C2	214-2	Junta Motor DT- 466
670079C2	214-3	Junta Tubo de Aceite Motor DT-360 y DT-466
253660R2	214-4	Junta Tubo de Aceite Motor DT-360 y DT-466
675384C2	214-5	Junta Termostato Motor DT-360 y DT-466
673973C4	214-6	Junta Soporte Tubo Escape Motor DT-466
675808C2	214-7	Junta Bomba de Agua Motor DT-360 y DT-466 (Bomba Grande)
675816C2	214-8	Junta Tapa Bomba Inyección Motor DT-360 y DT-466
675398C2	214-9	Junta Tapa Filtro de Aceite Motor DT-360 y DT-466
675609C2	214-10	Junta Adaptadora Tapa de Inyección Motor DT-360 y DT-466
676988C2	214-11	Junta Bomba de Agua Motor DT-360 y DT-466 (Bomba Chica)

**DT-360 Y DT-466**

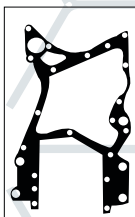

214-12



214-13

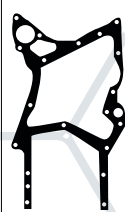

214-14

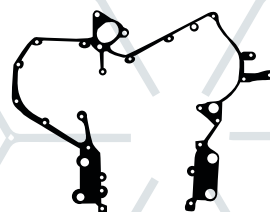

214-15



214-16



214-17



214-18



214-20



214-21



214-23

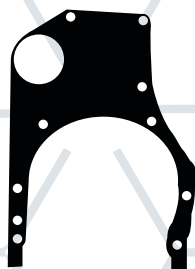

214-19



214-22

ORIGINAL	FIRTS	APLICACIÓN
683791C2	214-12	Junta Cubierta Frontal Motor DT-466
675813C2	214-13	Junta Cubierta Frontal Motor DT-466
675812C2	214-14	Junta Cubierta Frontal Motor DT-466
677082C3	214-15	Junta Cubierta Frontal Motor DT-466
671821C2	214-16	Junta Tubo Bomba de Aceite DT-466
1802867C2	214-17	Junta Tubo Bomba de Aceite DT-466
	214-18	Junta
682945C3	214-19	Junta Tapa Volante Motor DT-360 y DT-466
675513C1	214-20	Junta Enfriador de Aceite Motor DT-360 y DT-466
1810699C4	214-21	Junta Respiradero Motor DT-360 y DT-466
1810510C3	214-22	Junta Cubierta Frontal Motor DT-360
1816722C2	214-23	Junta Bomba de Aceite

**MJ-2106-1E  
AL1824970 C98  
JUEGO SUPERIOR NAVISTAR 466  
ELECTRÓNICO**

Original	Firts	Cantidad
1817562C4	CA-2106	1
670073C2	ES-2104-T	1
1820936C1	JUNTA	1
670073C2	JUNTA	1
1822577C1	MU-2106-A	1
1825436C1	MU-2106-E	1
1825602C91	PS-2106-Y	1
675447C1	ROLDANA	6
	SELLOS	6
	SELLOS	6
	O'RING	14

**MJ-2106-1M  
AL1822328 C95  
JUEGO SUPERIOR NAVISTAR 466  
MECÁNICO**

Original	Firts	Cantidad
1817562C4	CA-2106	1
670073C2	ES-2104-T	1
1820936C1	JUNTA	1
670073C2	JUNTA	1
1825436C1	MU-2106-E	1
1817510C1	PS-2106-X	1
675447C1	ROLDANA	6
	SELLOS	6
	O'RING	1

**MJ-2106-2E  
MEDIO JUEGO INFERIOR NAVISTAR NGD  
ELECTRÓNICO**

Original	Firts	Cantidad
1824984 C94	VD-068	1
1823182 C91	VD-067	1
1817562 C4	CJ-2106	1

**MJ-2106-2M  
MEDIO JUEGO INFERIOR NAVISTAR NGD  
MECÁNICO**

Original	Firts	Cantidad
1824984 C98	VD-065	1
1823182 C91	VD-067	1
1817562 C4	CJ-2106	1

## NGD MOTORES 466 Y 530 MECÁNICO Y ELECTRÓNICO

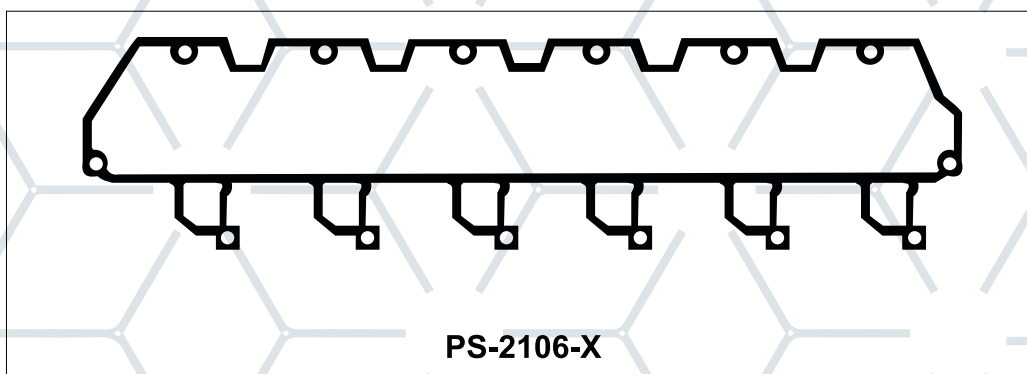
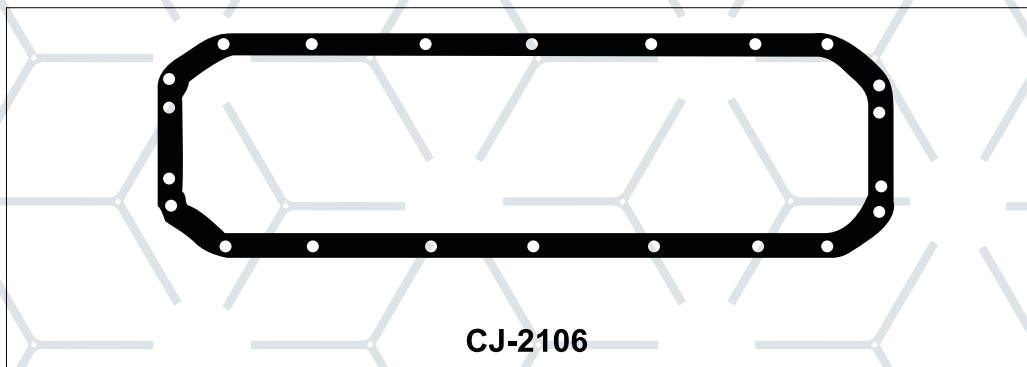
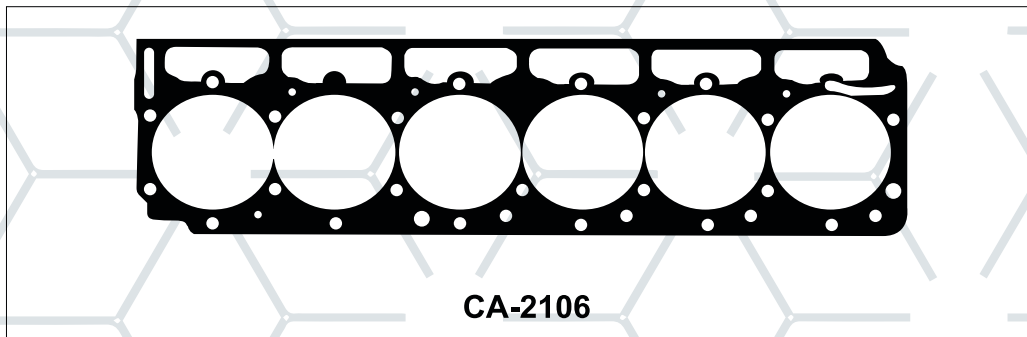

NAVISTAR

ORIGINAL	FIRTS	APLICACIÓN
1817562C4	CA-2106	Junta de Cabeza DT-408, DT-466, 530, 466-E y 530-E
1856587C1	CJ-2106	Junta Cáster Motor NGD
1817510C1	PS-2106-X	Junta Tapa de Punterías DT-466, 530 Mecánico

**NGD MOTORES 466 Y 530 MECÁNICO Y ELECTRÓNICO**

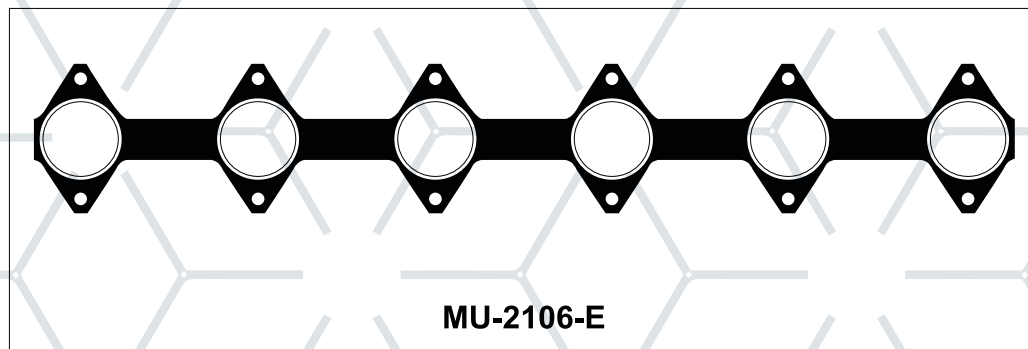
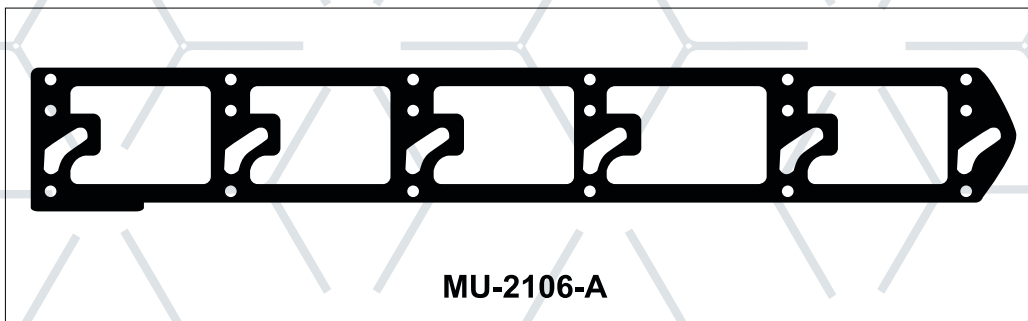
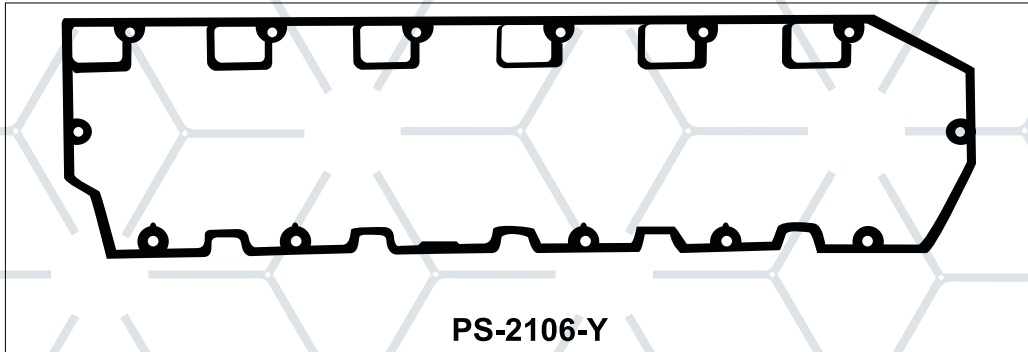

NAVISTAR

ORIGINAL	FIRTS	APLICACIÓN
1825602C91	PS-2106-Y	Junta Tapa de Punterías DT-466, 530 Electrónico
1822577C1	MU-2106-A	Junta Múltiple de Admisión DT-466, 530 Electrónico
1825436C1	MU-2106-E	Junta Múltiple de Escape DT-408, DT-466, 530, 466-E, 530-E

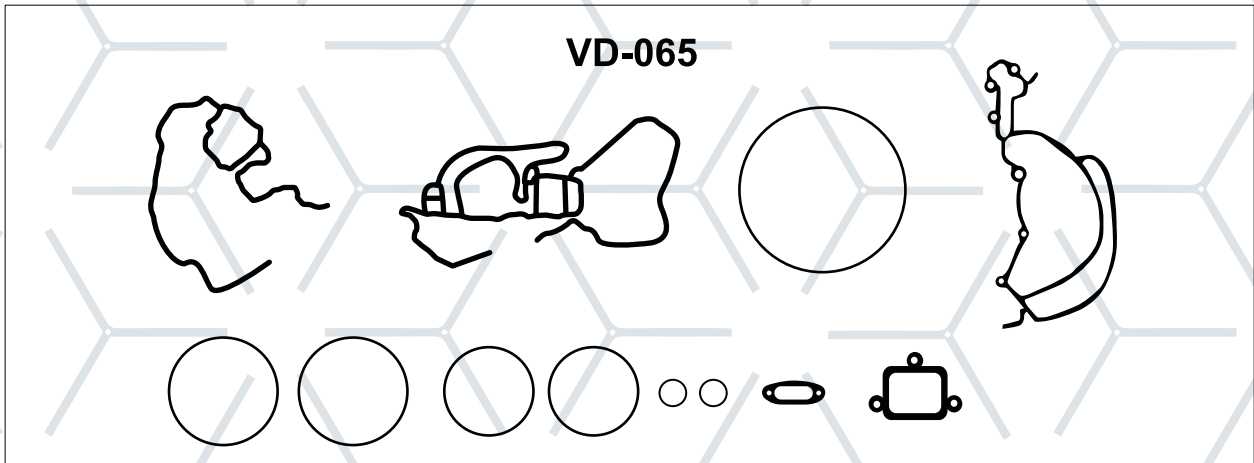

JUEGO DE LIGAS PARA DISTRIBUCIÓN NAVISTAR NGD DT-446, MECANICO (182 2365C98)

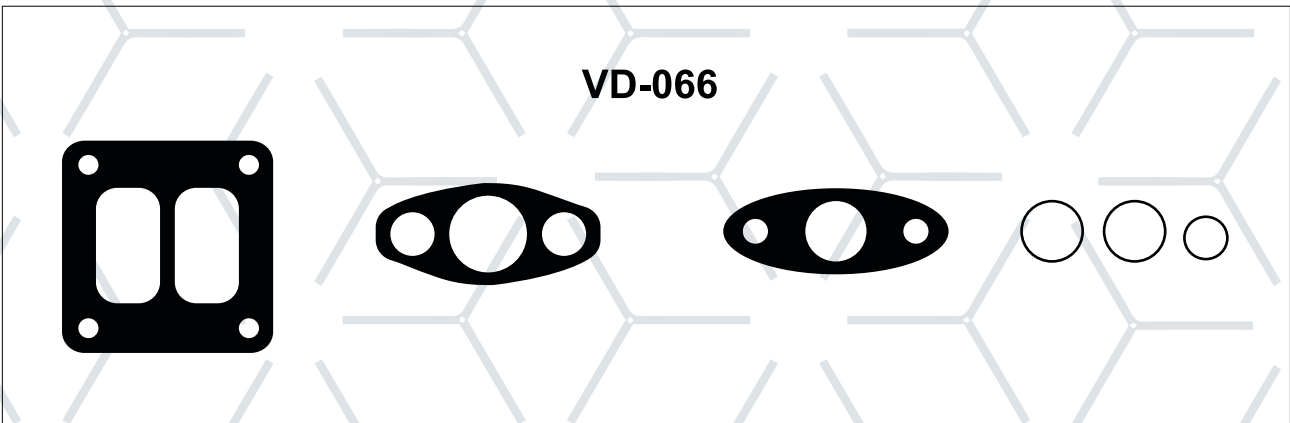

JUEGO DE JUNTAS PARA MONTAJE DEL TURBO NAVISTAR DT-466, DT-408, 530, DT-466 NGD (1823 181C91)

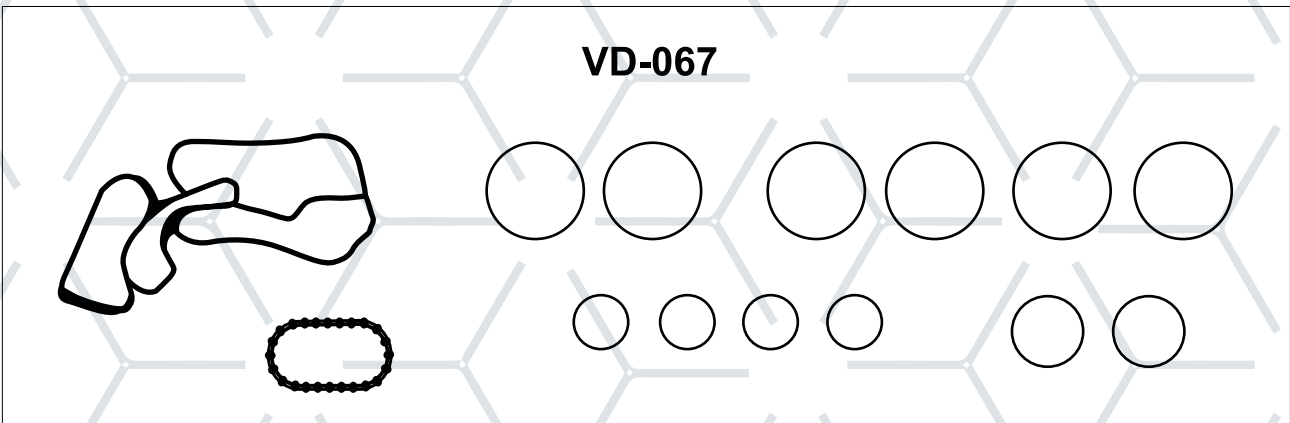

JUEGO DE SELLOS PARA ENFRIADOR DE ACEITE NAVISTAR NGD DT-466, DT-408, 530 (1823 182C91)

NAVISTAR

**VD-068**

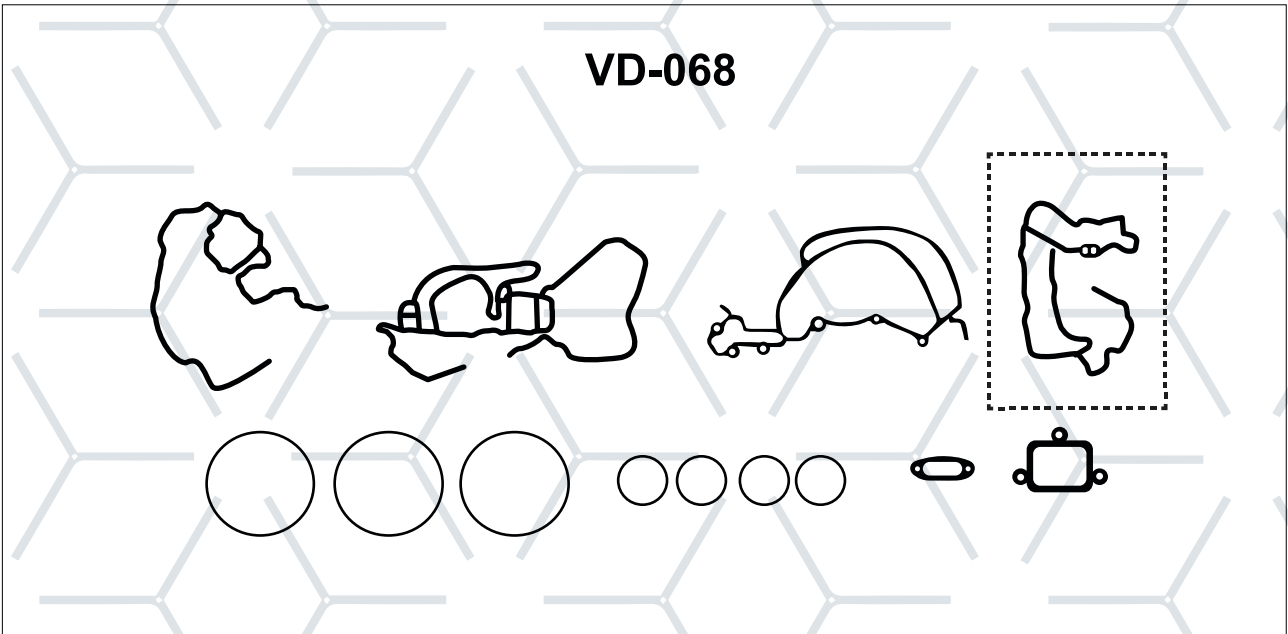

**JUEGO DE LIGAS PARA DISTRIBUCIÓN NAVISTAR NGD DT-466 ELECTRÓNICO  
(182 4984C94)**

**VD-069-6**

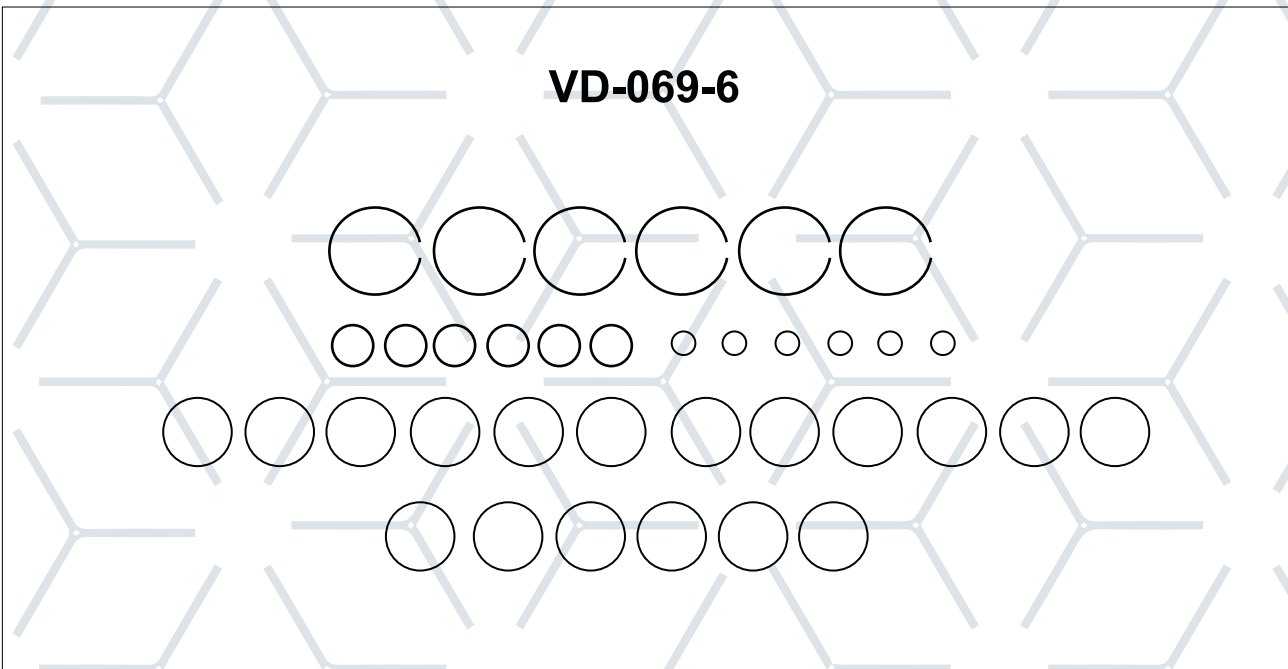

**KIT DE AFINACIÓN PARA 6 INYECTORES NAVISTAR NGD ELECTRÓNICO 466 Y 530  
(1833 564C92)**

VD-069-1

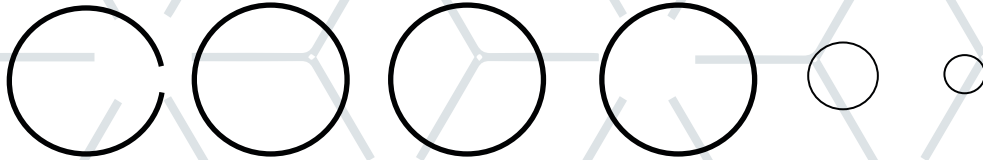

KIT DE AFINACIÓN PARA 6 INYECTORES NAVISTAR NGD ELECTRÓNICO 466 Y 530  
(1833 564C92)

VD-070



O'RING



214-20



214-20

JUEGO DE JUNTAS PARA ENFRIADO DE ACEITE DT 360 Y DT 466 (HASTA 1993)

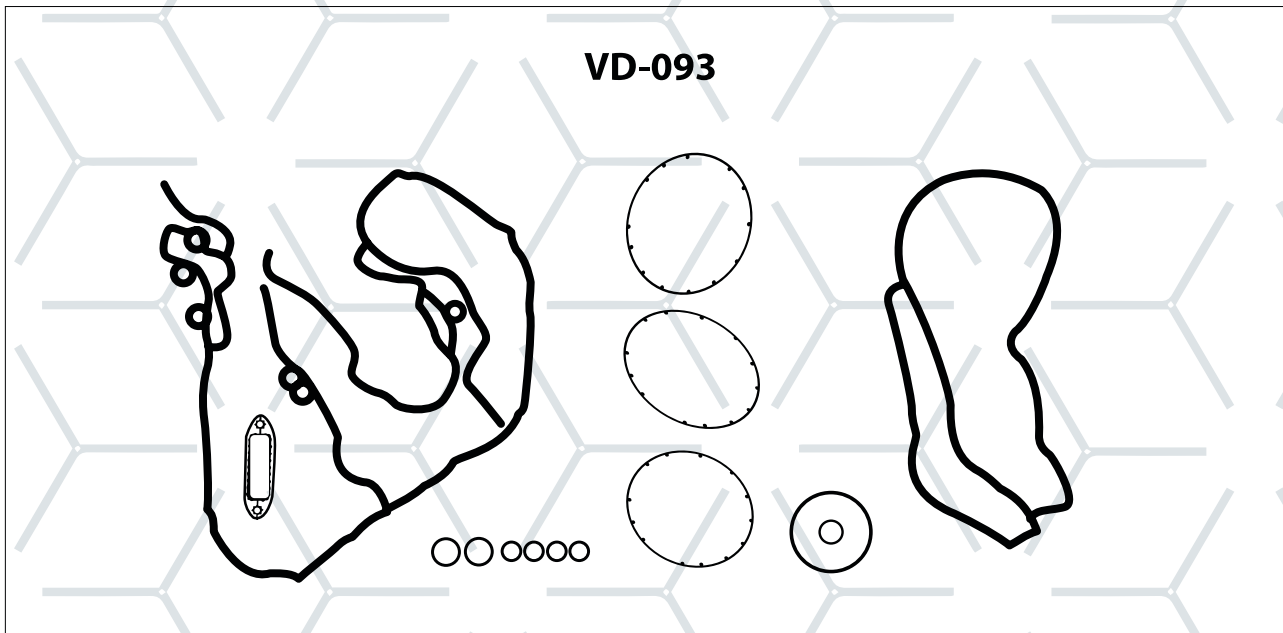

**JUEGO DE LIGAS DISTRIDUCIÓN MAXX FORCE NAVISTAR**

NAVISTAR

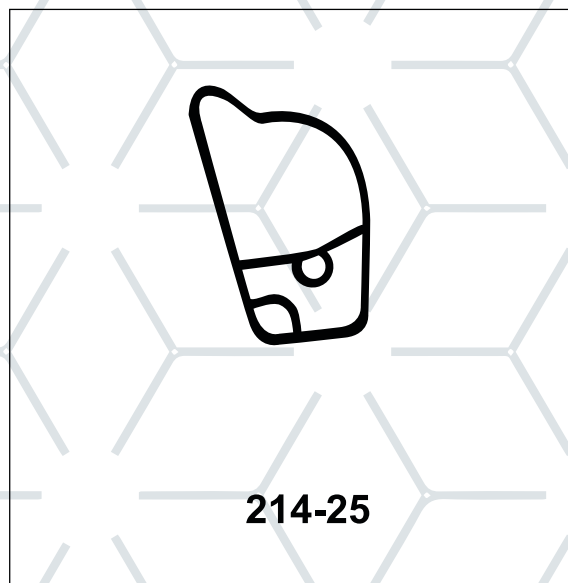
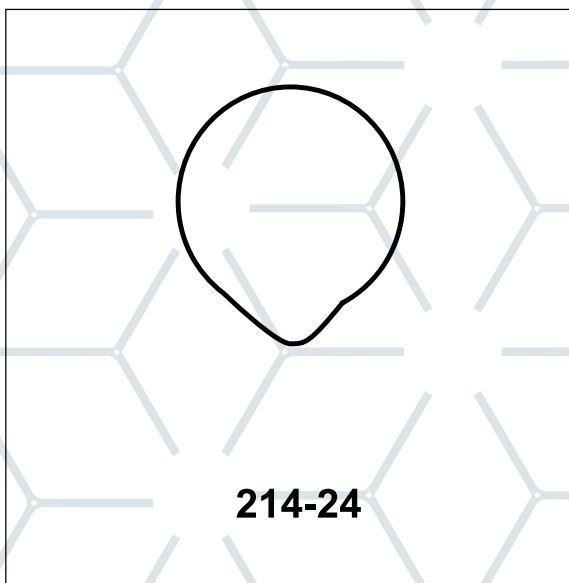

ORIGINAL	FIRTS	APLICACIÓN
1818727C1	214-24	Liga Base de Compresor Navistar
1825685C1	214-25	Liga Bomba de Alta Presión Navistar

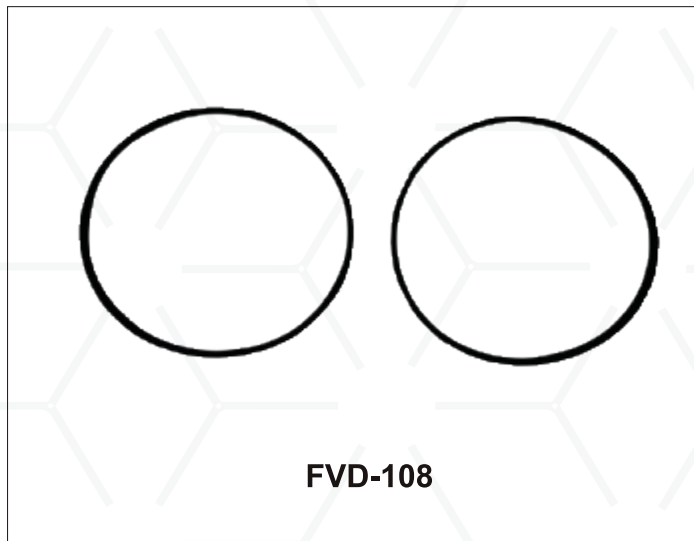

ORIGINAL	FIRTS	APLICACIÓN
1841974C1 1817862C1	214-27 FVD-108	Liga de Reten Trasero Cigüeñal Juego Ligas Bomba aceite Navistar

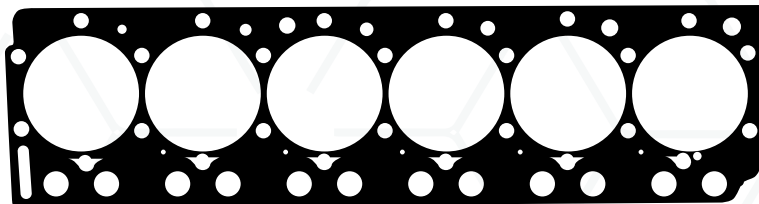

CA-2107



FMU-2107-A



FMU-2107-E



F214-30

ORIGINAL	FIRTS	APLICACIÓN
1885879C1-1833028C1	CA-2107	Junta de cabeza Max Force I313
1842033C1	FMU-2107-A	Junta Multiple Admision NAVISTAR MAX FORCE
1886293CI	FMU-2107-E	Junta Multiple Escape NAVISTAR MAX FORCE
183600FC1	F214-30	Junta Multiple Admision NAVISTAR MAX FORCE

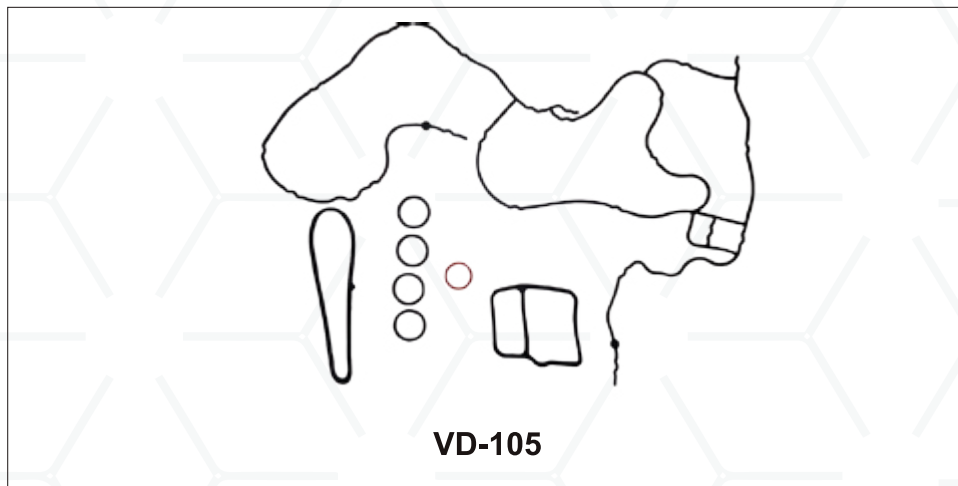
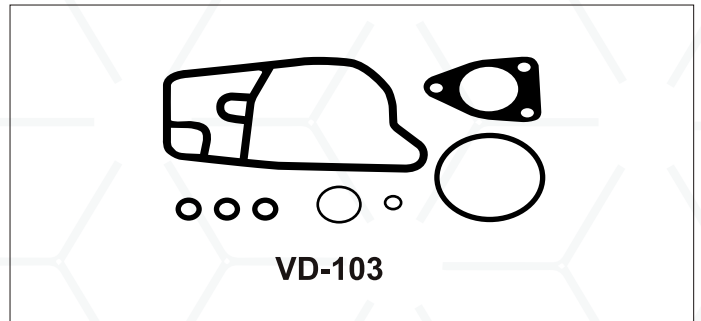
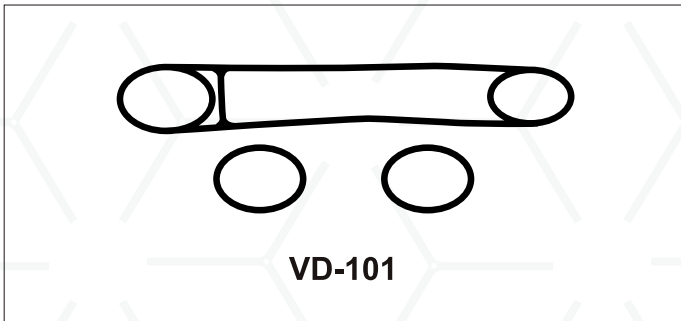
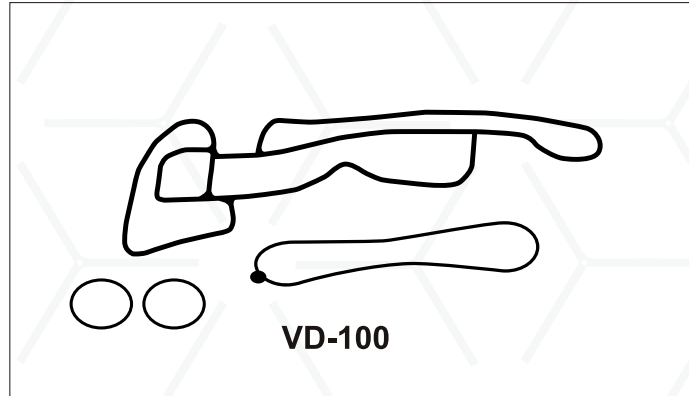
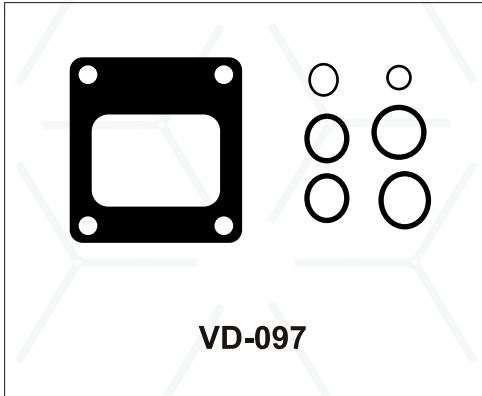

ORIGINAL	FIRTS	APLICACIÓN
1842623C93	VD-097	Kit de montaje Turbo Max Force I3I3
1842124C91	VD-100	Ligas carcasa enfriador aceite Max Force I3I3
1842126C91	VD-101	Ligas enfriador aceite Max Force I3I3
	VD-103	Juego ligas y junta boma alta presión Navistar NGD
	VD-105	Juego de ligas tapa distribución trasera Navistar Max Force





Mercedes-Benz

**MERCEDES BENZ**

**MERCEDES BENZ MOTOR OM-366**

**JUEGO DE JUNTAS ..... 83**

**PIEZAS SUeltas ..... 85**

**VARIOS DIESEL ..... 89**

**VD-071                      Juegos de Ligas para Distribución**

**VD-075                      Juego de Juntas para Bomba de Agua**

**VD-078                      Juego de Juntas TURBO Mercedes Benz 904-906 Gráfico**

**MERCEDEZ BENZ OEM 904,906,924,926..... 103**



**JC-366-L**  
**JUEGO COMPLETO MOTOR OM-366**  
**PARA MERCEDES BENZ**

Original	Firts	Cantidad
3520150160	366-1	1
3449977041	366-2	2
3520150520	366-3	1
3120150580	366-4	1
0149971647	366-5	1
3520150380	366-6	1
0000911880	366-7	1
3520760280	366-8	1
3660981080	366-9	1
3621880080	366-10	1
3661880080	366-11	1
91700302600	366-12	2
3141840179	366-13	1
3622010080	366-14	1
3662030080	366-15	1
3520780080	SEGUROS	6
3522010480	366-16	1
0000911880	366-17	1
	366-18	1
3660160020	CA-366	1
3660100680	CJ-366	1
3661410580	MU-366-A	3
3661420180	MU-366-E	4
	O-RING	7
3660160021	PS-366	1
	ROLDANA	52
	SV-366	6

**MJ-366-1**  
**JUEGO SUPERIOR MERCEDES BENZ**  
**OM 366**

Original	Firts	Cantidad
3141840179	366-13	1
3662030080	366-15	1
3520780080	SEGURO	6
3660160020	CA-366	1
3661410580	MU-366-A	3
3661420180	MU-366-E	4
3660160021	PS-366	1
	SV-366	6

**MJ-366-1C**  
**JUEGO SUPERIOR MERCEDES BENZ**  
**OM 366**

Original	Firts	Cantidad
3141840179	366-13	1
3662030080	366-15	1
3520780080	SEGURO	6
3660160020	CA-366	1
3660100680	CJ-366	1
3661410580	MU-366-A	3
3661420180	MU-366-E	4
3660160021	PS-366	1
	SV-366	6

**MERCEDES-BENZ**

**MJ-MB-904-1**  
**JUEGO SUPERIOR MERCEDES BENZ**  
**OM 904**

Original	Firts	Cantidad
351008	CA-MB-904	1
351032	PS-MB-904-G	1
351017	MU-MB-904-A	2
350815	MU-MB-904-E	2

**MJ-MB-906-1**  
**JUEGO SUPERIOR MERCEDES BENZ**  
**OM 906**

Original	Firts	Cantidad
	CA-MB-906	1
	PS-MB-906-G	1
351017	MU-MB-906-A	3
350815	MU-MB-906-E	3

**MOTOR OM-366**

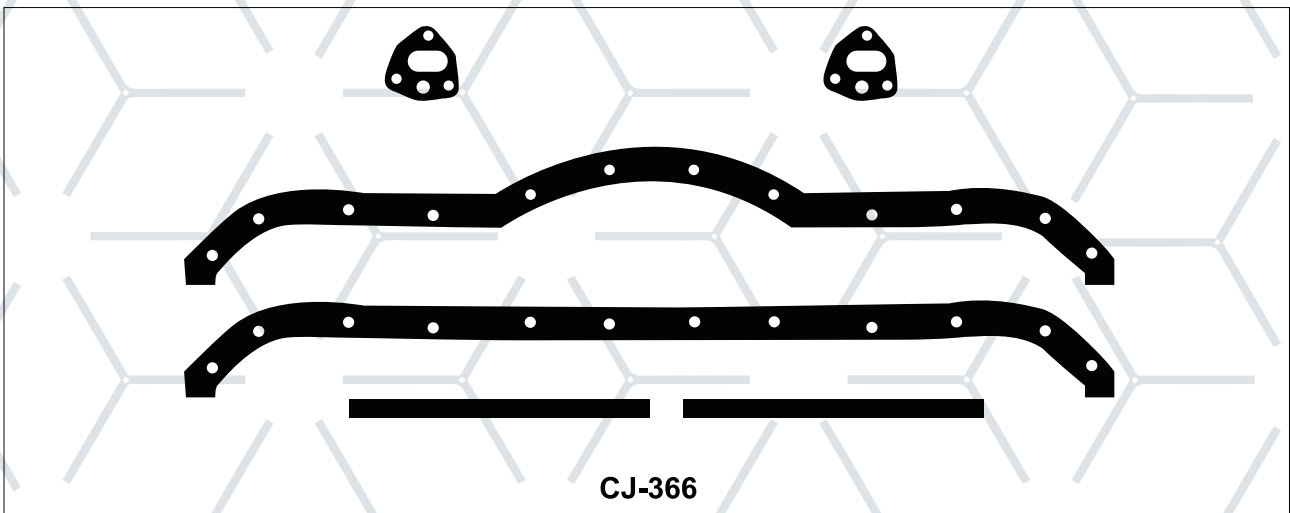
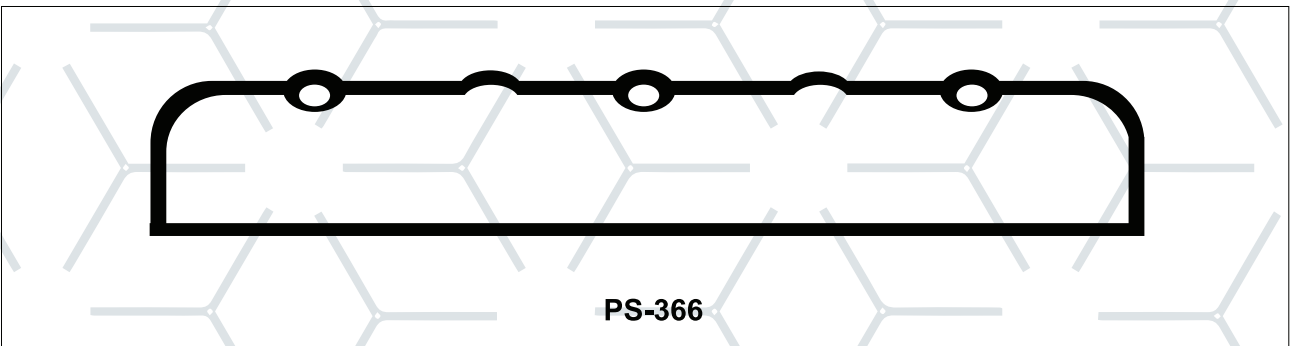
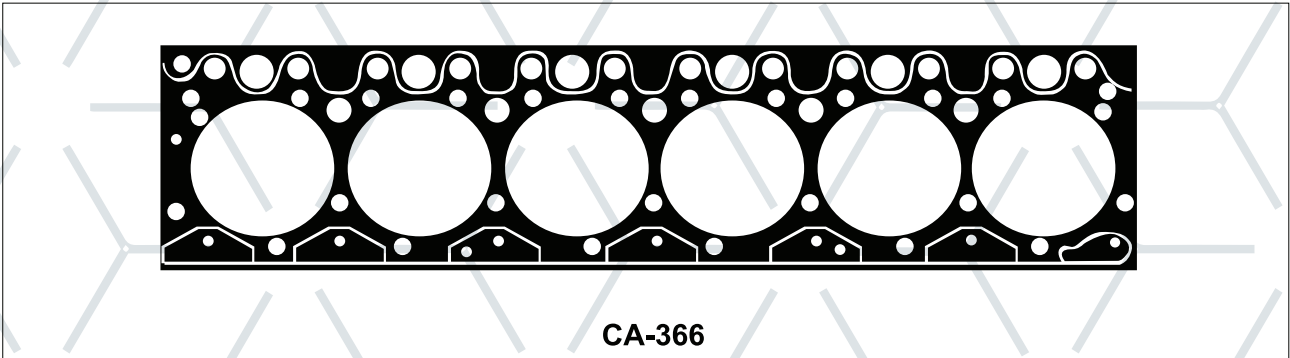

MERCEDES-BENZ

ORIGINAL	FIRTS	APLICACIÓN
3660160020	CA-366	Junta de Cabeza
3660160021	PS-366	Junta Tapa de Punterías
3660100680	CJ-366	Junta Cárter

**MOTOR OM-366**

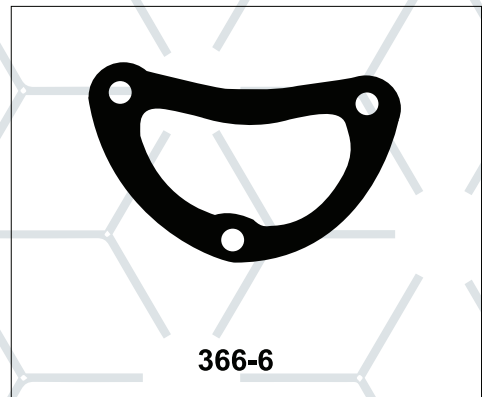
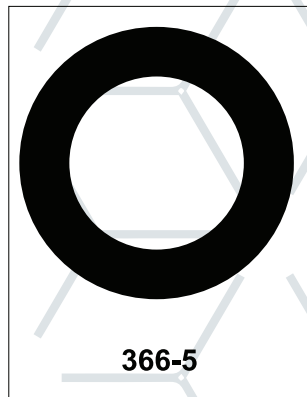
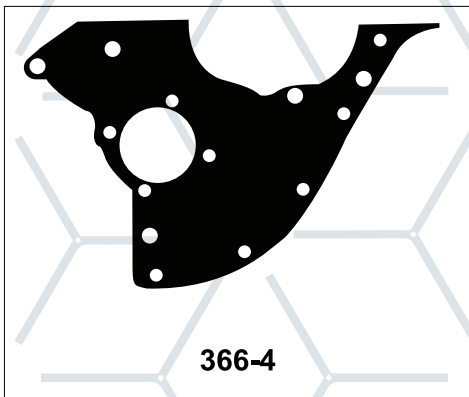
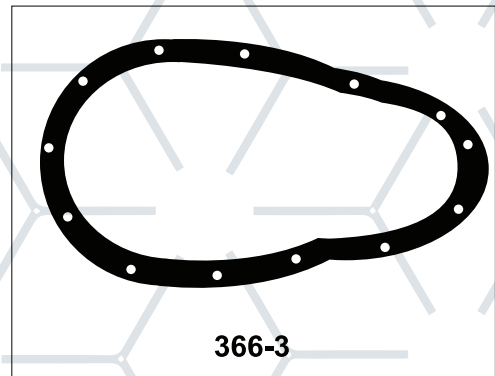
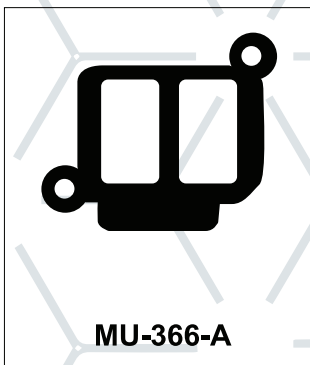
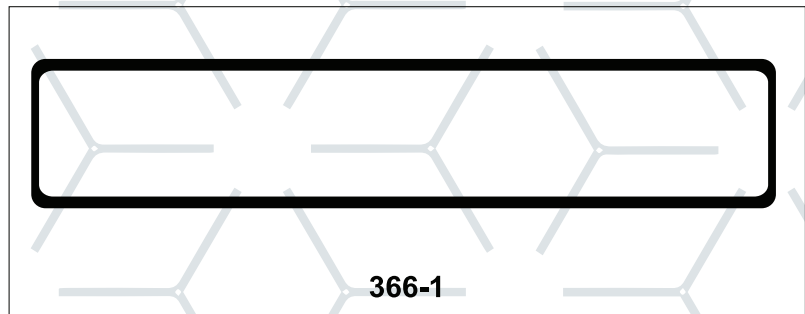
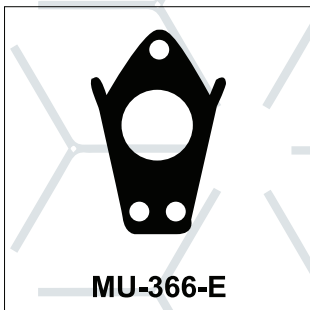

MERCEDES-BENZ

ORIGINAL	FIRTS	APLICACIÓN
3661420181	MU-366-E	Junta Múltiple de Escape
3661410580	MU-366-A	Junta Múltiple de Admisión
3520150160	366-1	Junta Anular
3449977041	366-2	Colillas de Cigüeñal
3520150520	366-3	Junta de Distribución Delantera
3120150580	366-4	Junta de Distribución Trasera
0149971647	366-5	Retén
3520150380	366-6	Junta de Distribución

**MOTOR OM-366**

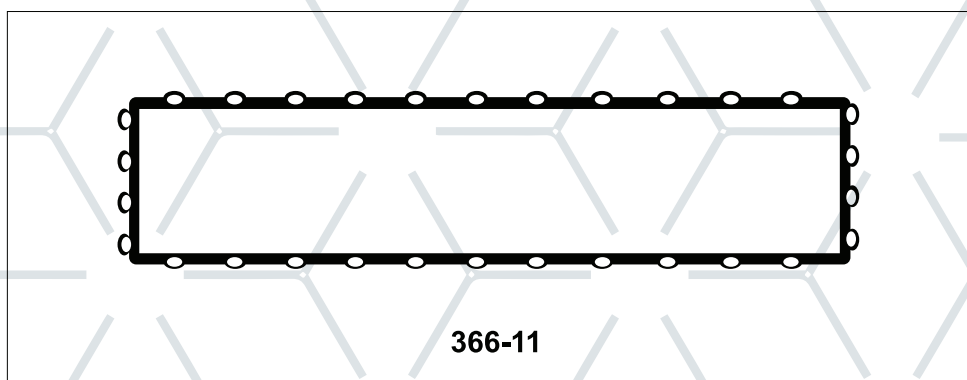
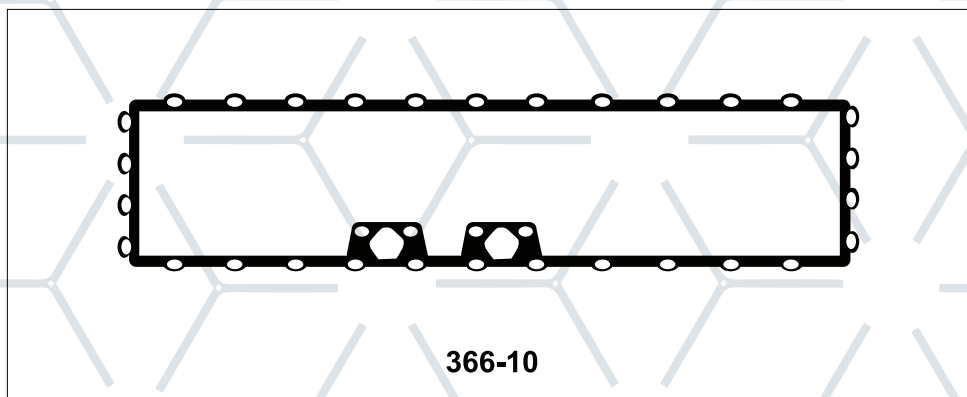
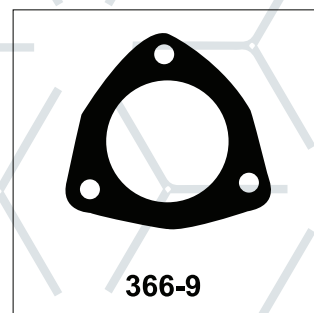
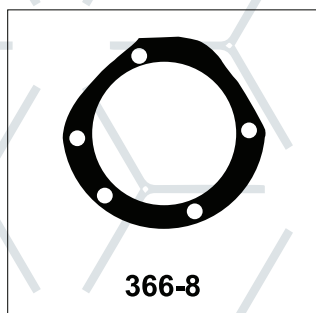
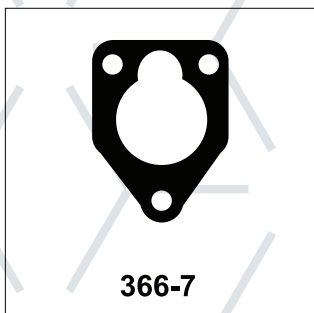

**MERCEDES-BENZ**

ORIGINAL	FIRTS	APLICACIÓN
0000911880	366-7	Junta de Bomba de Combustible
3520760280	366-8	Junta de Bomba de Inyección
3660981080	366-9	Junta Tubo Múltiple Admisión
3621880080	366-10	Junta Enfriador de Aceite
3661880080	366-11	Junta Enfriador de Aceite

**MOTOR OM-366**

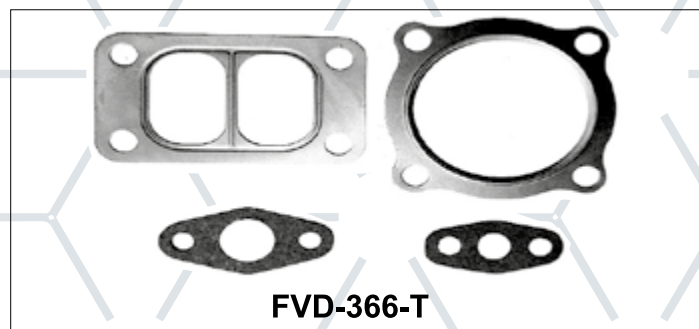
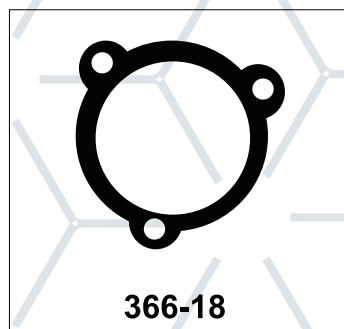
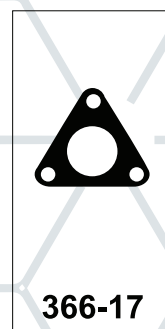
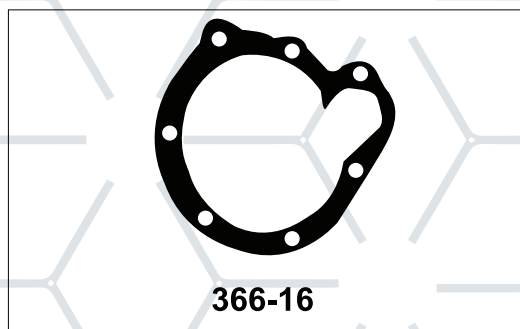
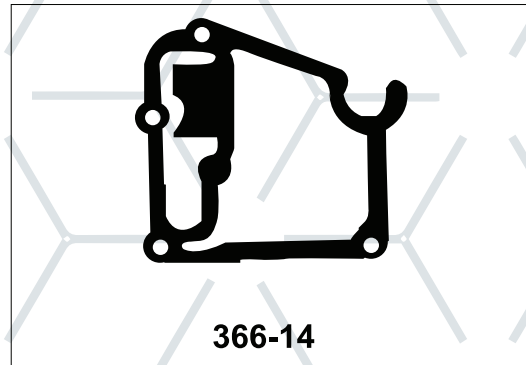
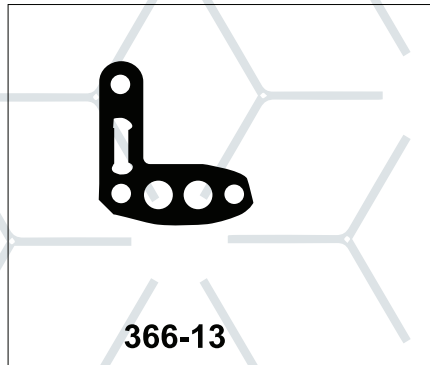
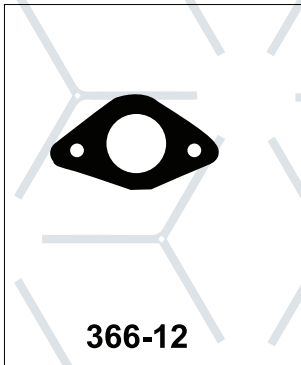

MERCEDES-BENZ

ORIGINAL	FIRTS	APLICACIÓN
917003026000	366-12	Junta Enfriador Aceite
3141840179	366-13	Junta Lubricación
3622010080	366-14	Junta Bomba de Agua
3662030080	366-15	Junta Conector Bomba de Agua a Termostato
3522010480	366-16	Junta de Agua
0000911880	366-17	Junta Bomba de Combustible
	366-18	Junta
	FVD-366-T	Juego Juntas Turbo Mercedes 366

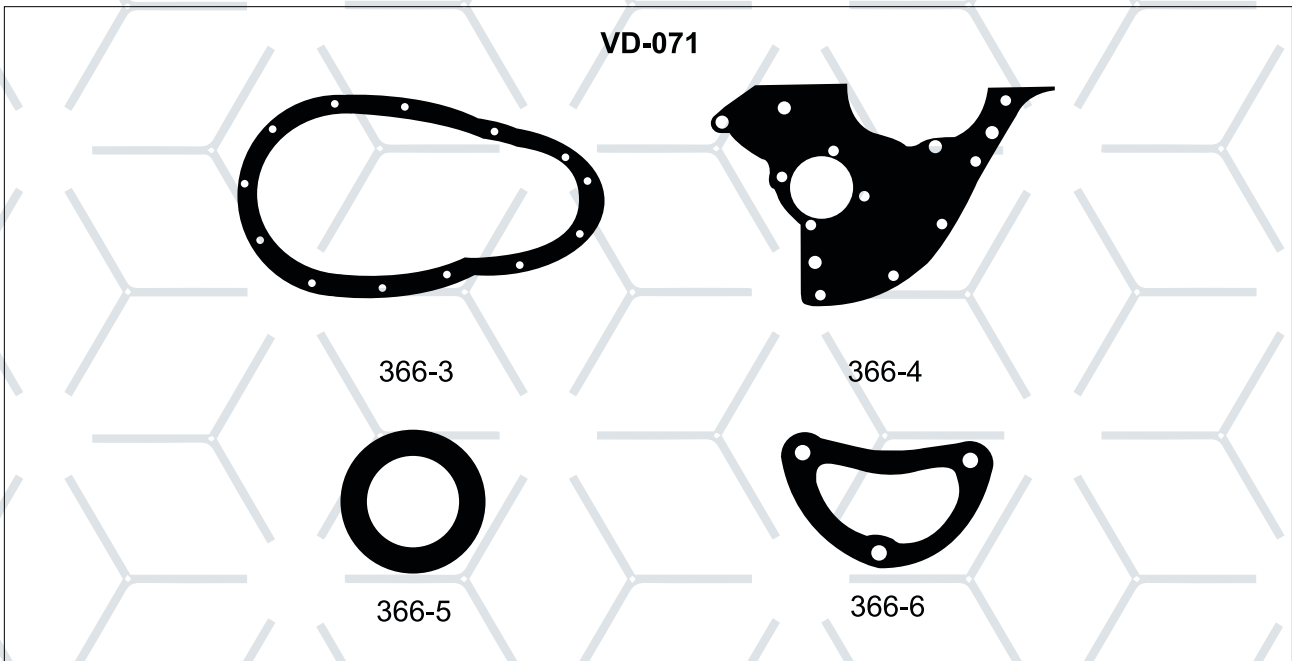

JUEGO DE JUNTAS PARA DISTRIBUCIÓN MERCEDES BENZ OM-366

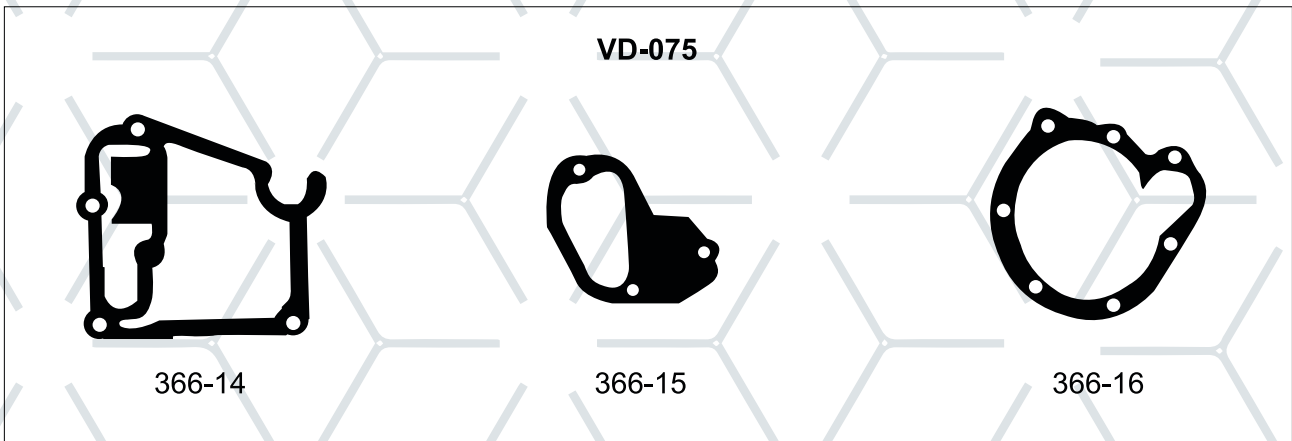

JUEGO DE JUNTAS PARA BOMBA DE AGUA MERCEDES BENZ OM-366

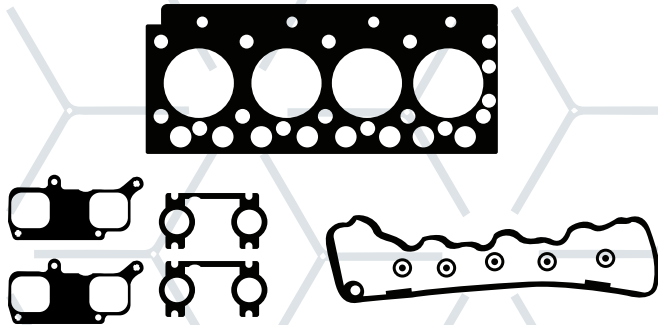

**MJ-MB-904**



**CJ-MB-904**



**CJ-MB-906**

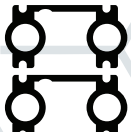

**MU-MB-904-E**

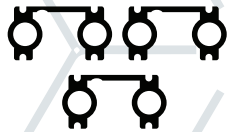

**MU-MB-906-E**

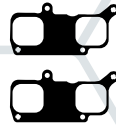

**MU-MB-904-A**

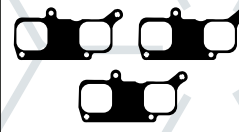

**MU-MB-906-A**



**MB-904-1**



**MB-904-2**



**MB-904-3**



**MB-904-4**

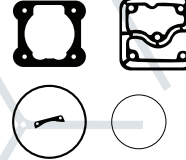

**VD-076**

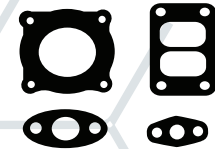

**VD-078**

**ORIGINAL**

**FIRTS**

**APLICACIÓN**

MJ-MB-904

Medio Juego Superior Mercedes Benz 904

CJ-MB-904

Junta Cáster Mercedes Benz OM 904

6132800

CJ-MB-906

Junta Cáster Mercedes Benz OM 906

9061420280

MU-MB-904-E  
MU-MB-906-E

Junta Múltiple Escape Mercedes Benz 904, 906

9061410180

MU-MB-904-A  
MU-MB-906-A

Junta Múltiple Admisión Mercedes Benz 904, 906

0001883280

MB-904-1

Junta Filtro de Aceite Mercedes Benz 904 y 906

MB-904-2

Junta Tubo de Succión de Aceite Mercedes Benz 904, 906

9041840280

MB-904-3

Junta Tapa radiador Aceite Mercedes Benz 904

MB-904-4

Junta Enfriador de Aceite Mercedes Benz 904

VD-076

Juego Juntas compresor Aire Mercedes Benz 904, 906

VD-078

Juego de Juntas TURBO Mercedes Benz 904-906 Gráfito

MERCEDES-BENZ

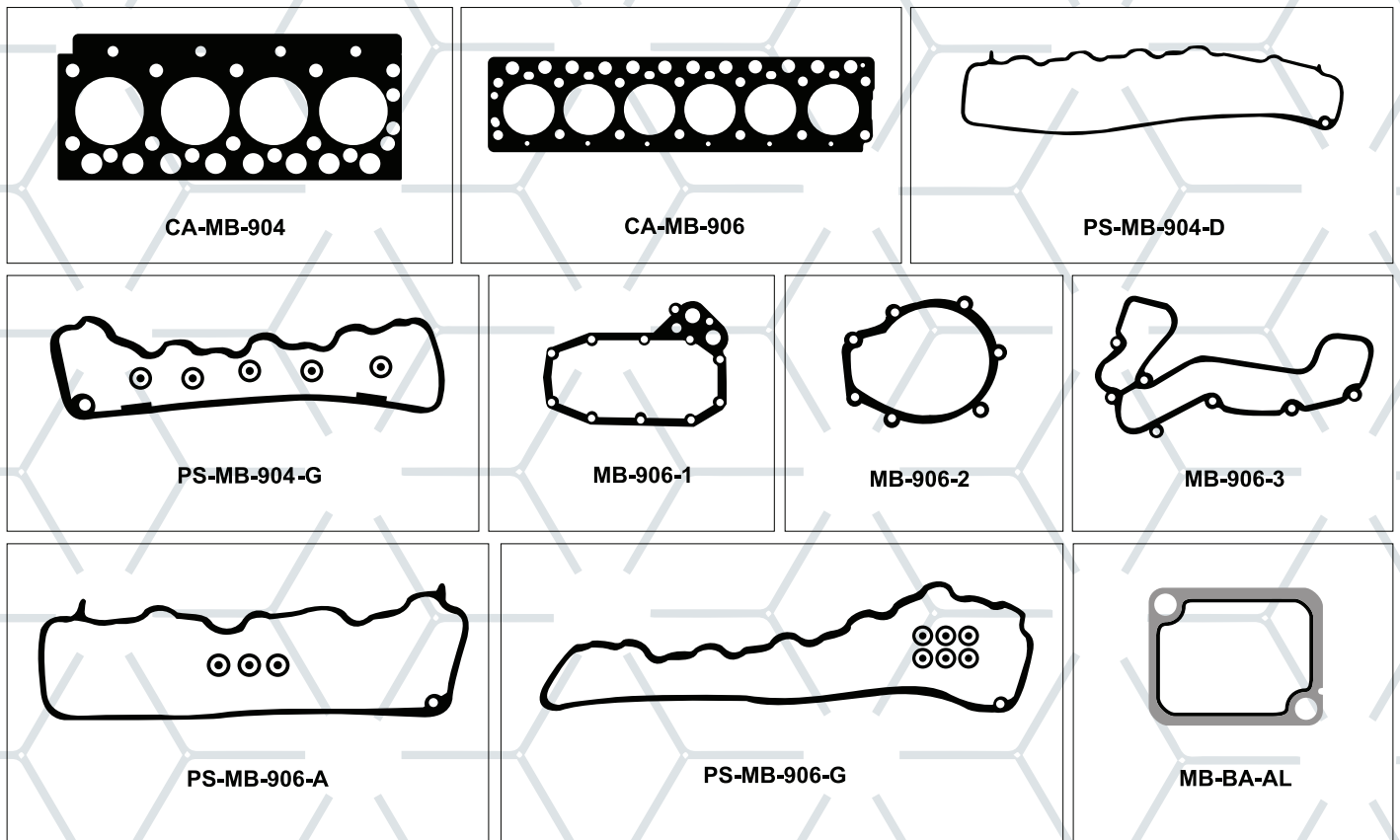

ORIGINAL	FIRTS	APLICACIÓN
9040161120	CA-MB-904	Junta de Cabeza Mercedes Benz 904 Lámina
	CA-MB-906	Junta de Cabeza Mercedes Benz 906
00016421	PS-MB-904-D	Junta Tapa de Punterías Mercedes Benz 904 tapa Aluminio
	PS-MB-904-G	Junta Tapa de Punterías Mercedes Benz tapa Plástico
17132800	MB-906-1	Junta Enfriador de Aceite Mercedes Benz 906
	MB-906-2	Junta Bomba de Agua Mercedes Benz 906 y 904
00018832802	MB-906-3	Junta Tapa Radiador de Aceite Mercedes Benz 906
0000160521	PS-MB-906-A	Junta Tapa de Punterías Mercedes Benz 906 Tapa Aluminio
	PS-MB-906-G	Junta Tapa de Punterías Mercedes Benz 906 Tapa Plástico
	MB-BA-AL	Junta Bomba Agua Mercedes Benz 906 y 904 Aluminio

MERCEDES-BENZ



FMB-BC-LA



FES-MB-926-T



FMB-906-4

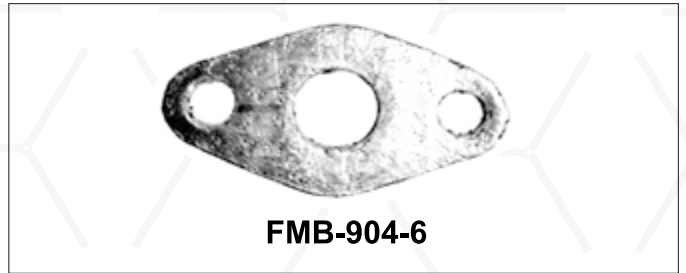

FMB-904-6

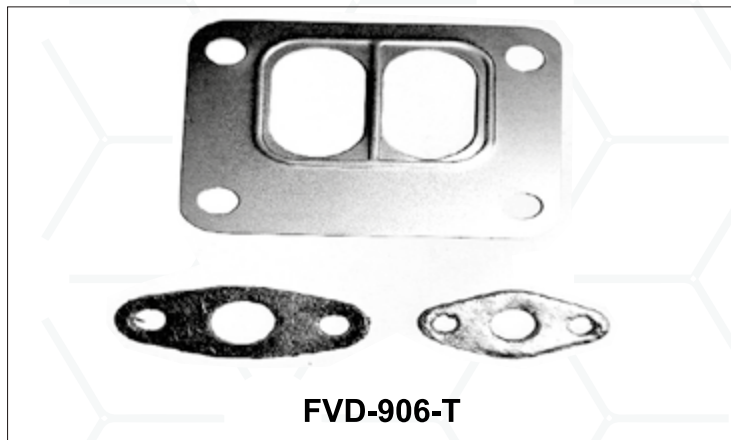

FVD-906-T

ORIGINAL	FIRTS	APLICACIÓN
	FMB-BC-LA	Junta bomba combustible Mercedes Benz 904-906
	FES-MB-926-T	Junta turbo Mercedes Benz 906 desentrada
	FMB-906-4	Junta de Retorno Turbo MB 906
	FMB-904-6	Junta de Retorno Turbo MB 904
	FVD-906-T	Juego Juntas Turbo Mercedes Benz 904-926

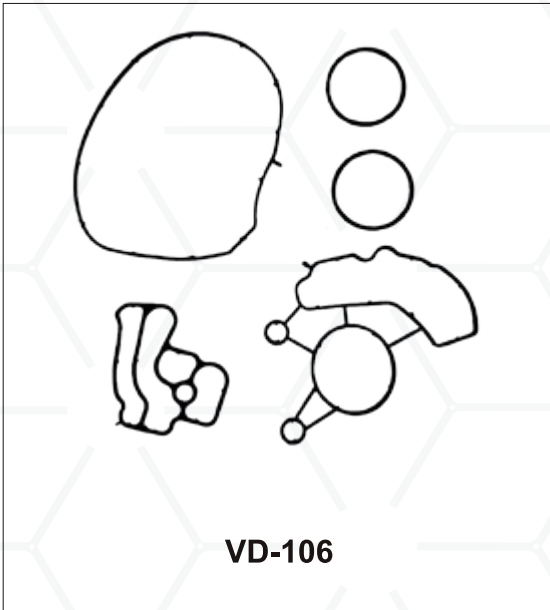

VD-106

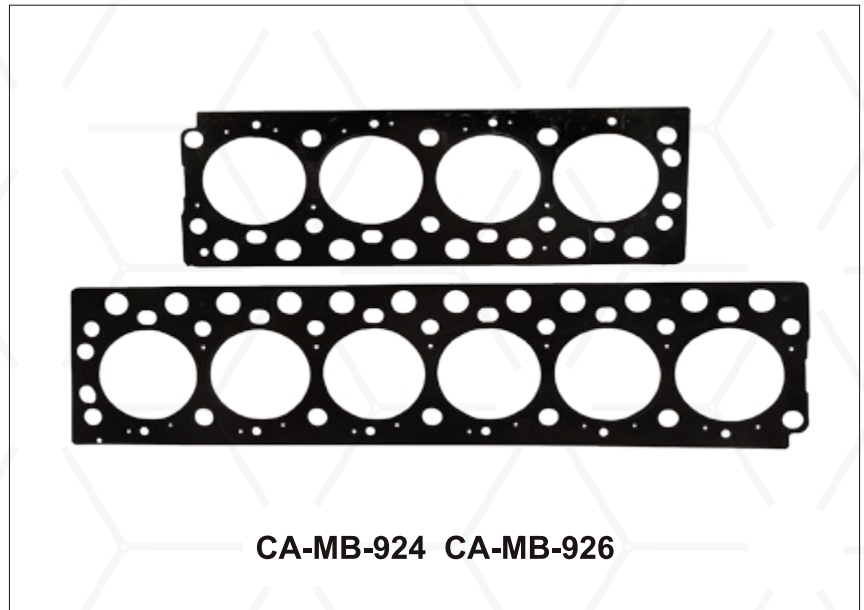

CA-MB-924 CA-MB-926



FMB-904-7

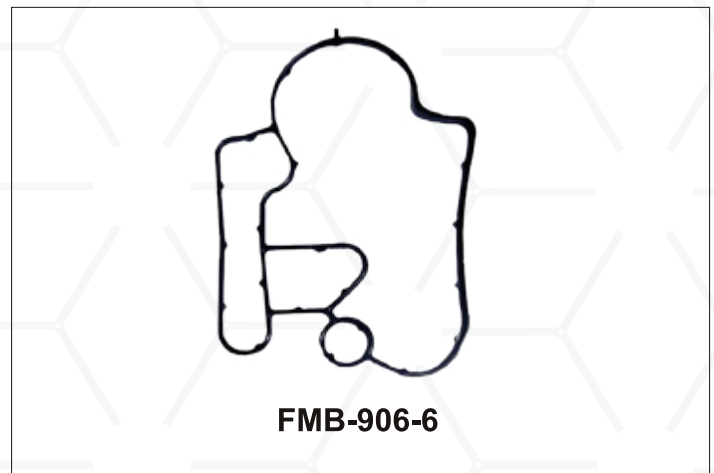

FMB-906-6

ORIGINAL	FIRTS	APLICACIÓN
	VD-106	Juego de ligas bomba de agua Mercedes Benz 904, 906, 924, 926
35M3108	CA-MB-924	Junta cabeza Mercedes Benz 924 Multilamina
35M3108	CA-MB-926	Junta cabeza Mercedes Benz 926 Multilamina
0020941580	FMB-904-7	Liga Base Filtro Diesel MB 904, 924, 906, 926
A9061840580	FMB-906-6	Liga Filtro Diesel MB 904, 924, 906, 926





## DETROIT

### DETROIT S-60

JUEGO DE JUNTAS ..... 95

PIEZAS SUeltas ..... 97

VARIOS DIESEL ..... 100

PS-600-T	Juegos de Sellos para Punterías	
TPS-600	Juego de Soportes para Punterías	
CJ-600-T	Juegos de Sellos para Cáster	
TCJ-600	Juego de Soportes para Cáster	
VD-L600	Juegos de Ligas para Camisa de Cilindro	
VD-072	Juego de Ligas para Árbol de Levas	
VD-073	Juegos de Ligas para Enfriador de Aceite	
VD-074	Juego de Juntas para Inyectar	
VD-077	Juego de Ligas Bomba de Agua Detroit S-60	



**JC-600  
AL23512691  
JUEGO COMPLETO DE JUNTAS PARA MOTOR DETROIT S-60**

Original	Firts	Cantidad
8929299	60-1	2
8929302	60-2	1
23515145	60-3	1
8929130	60-4	2
23505248	60-5	1
5150193	60-6	1
8929285	60-7	1
8929347	60-8	2
5117269	60-9	2
8929344	60-10	2
8929348	60-11	1
23522588	CA-600	1
8929529	ES-600-T	1
23517875	MU-600-A	3
23511666	MU-600-E	3
5132155	SELLO	2
5141452	SELLO	1
5182977	SELLO	1
8929253	SELLO	2
8929280	SELLO	2
8929289	SELLO	2
8929318	SELLO	1
8929340	SELLO	1
8929341	SELLO	1
8929342	SELLO	1
8929740	SELLO	3
23521111	SELLO	2
23521894	SELLO	1
23521935	SELLO	1
23522975	SELLO	1
	VD-074	6

**MJ-600-1  
AL23526852  
JUEGO SUPERIOR DETROIT SERIE S-60**

Original	Firts	Cantidad
8929130	60-4	1
8929285	60-7	1
23522588	CA-600	1
8929529	ES-600-T	1
23517875	MU-600-A	3
23511666	MU-600-E	3
23522975	SELLO	1
	SELLO	1
	SELLO	2
	SELLO	1
	SELLO	1
	VD-074	6

**MOTOR SERIE-60**

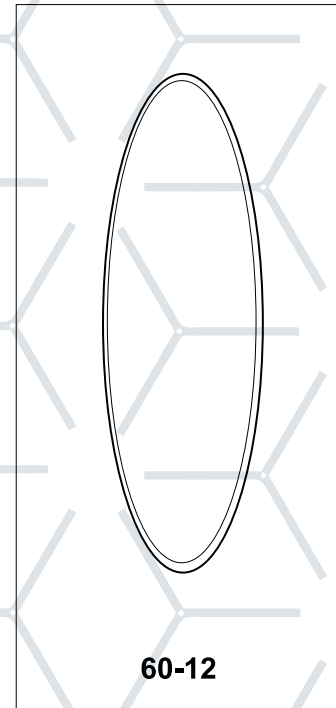
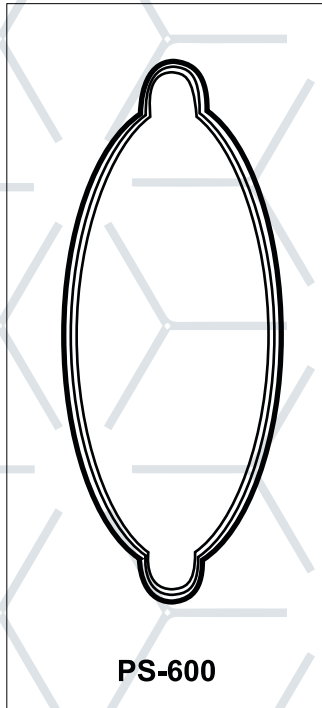
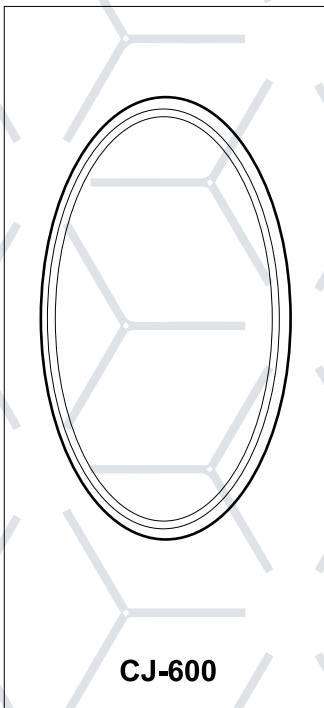
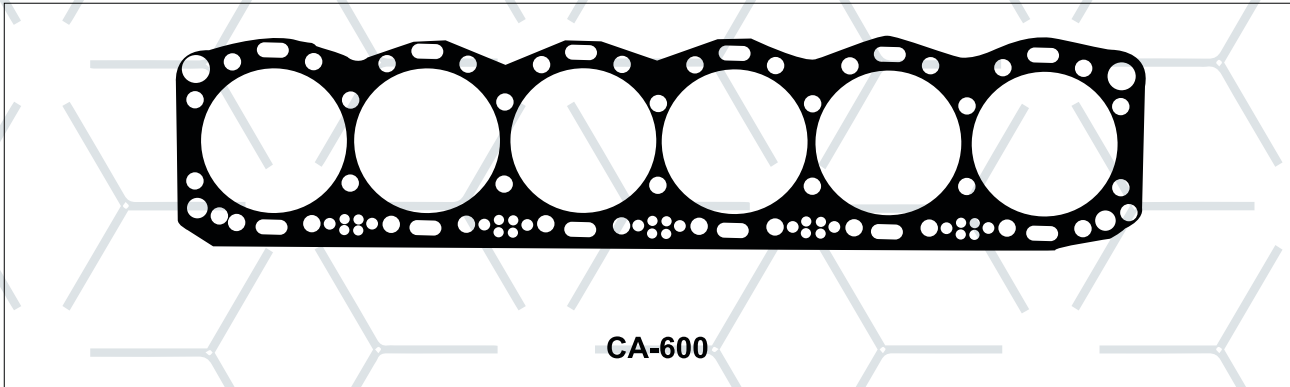

**DETROIT**

ORIGINAL	FIRTS	APLICACIÓN
2352588	CA-600	Junta de Cabeza
8929102	CJ-600	Liga para Tapa de Cárter
23516322	PS-600	Liga para Tapa de Punterías
8929803	60-12	Liga Aumento de Freno de Motor

**MOTOR SERIE-60**

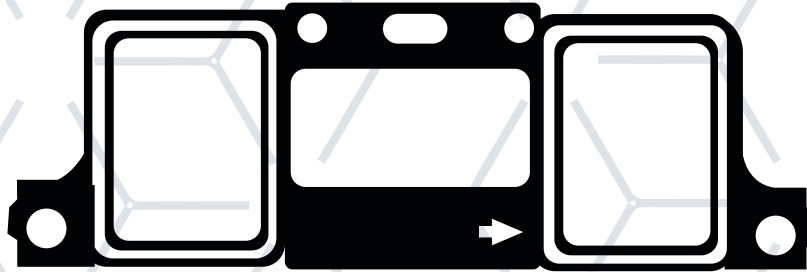

**MU-600-A**



**MU-600-E**



**ES-600-T**

DETROIT

ORIGINAL	FIRTS	APLICACIÓN
23517875	MU-600-A	Junta Múltiple de Admisión
23511666	MU-600-E	Junta Múltiple de Escape
8929529	ES-600-T	Junta de Turbocargador

**MOTOR SERIE-60**

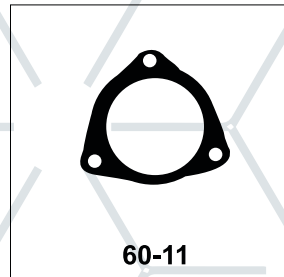
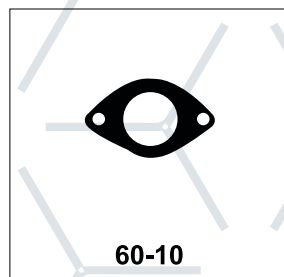
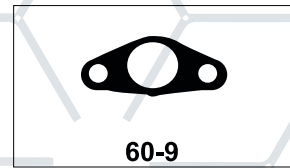
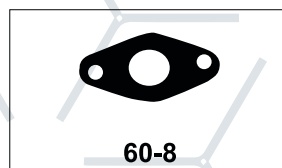
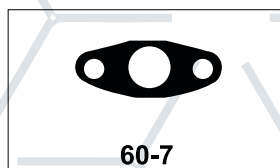
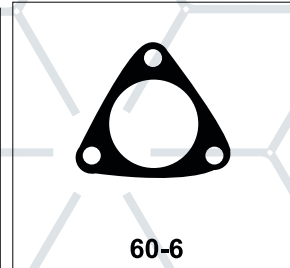
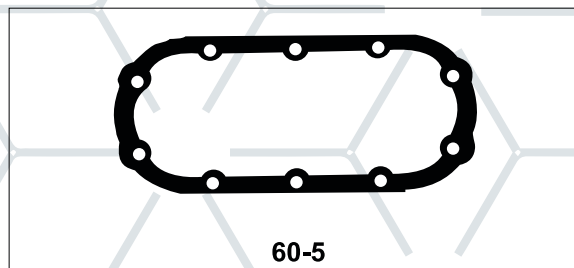
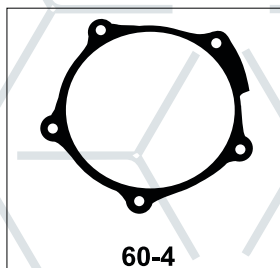
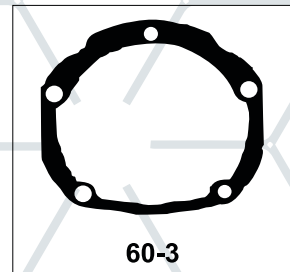
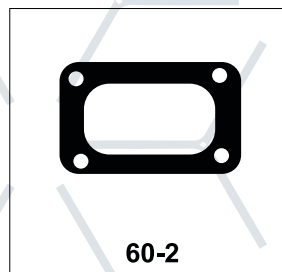
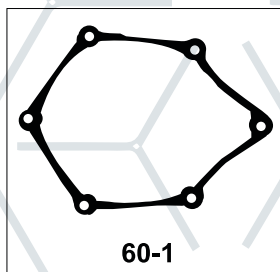

ORIGINAL	FIRTS	APLICACIÓN
8929299	60-1	Junta Toma de Fuerza
8929302	60-2	Junta Cubierta Filtro de Aceite
23515145	60-3	Junta Cubierta
8929130	60-4	Junta de la Tapa de Fuerza
23505248	60-5	Junta de la Bomba de Combustible
5150193	60-6	Junta Enfriador de Aceite
8929285	60-7	Junta Conexión Turbo
8929347	60-8	Junta de la Bomba de Aceite
5117269	60-9	Junta Regulador de Presión de Aceite
8929344	60-10	Junta de la Bomba de Aceite
8929348	60-11	Junta de la Bomba de Combustible

DETROIT

**PS-600-T**

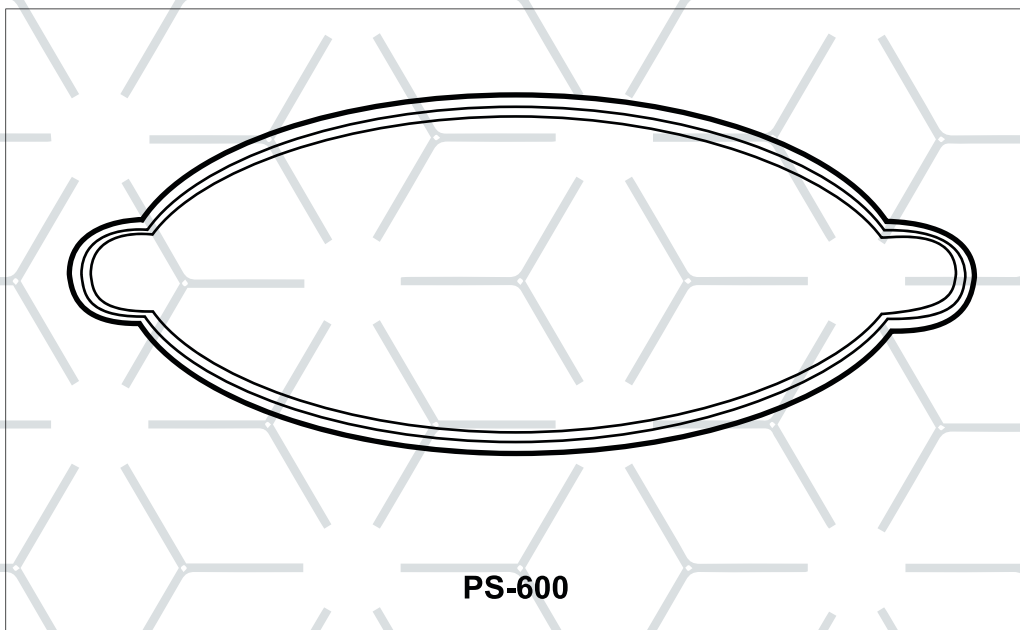

**TPS-600**



DETROIT

**JUEGO DE SELLOS PARA PUNTERÍAS MOTOR DETROIT S-60**  
INCLUYE: 1 PS-600 JUNTAS DE PUNTERÍAS (23516322) Y  
1 TPS-600 JUEGO DE SOPORTES (23517911)

**CJ-600-T**

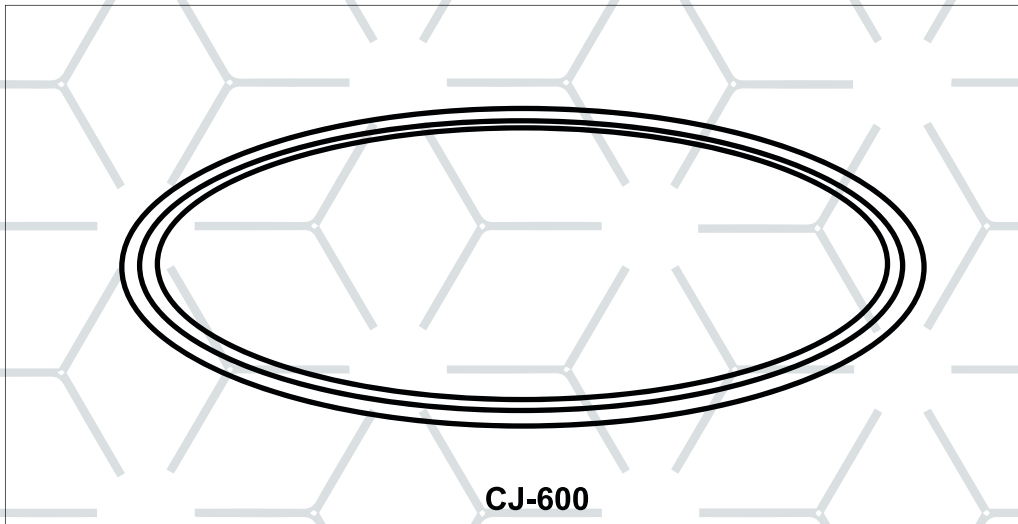

CJ-600

**TCJ-600**



**JUEGO DE SOPORTES PARA CÁRTER**

DETROIT

**JUEGO DE SELLO PARA CÁRTER MOTOR DETROIT S-60  
INCLUYE: 1 CJ-600 JUNTAS DE CARTER (8929102) Y  
1 TCJ-600 JUEGO DE SOPORTES (23517242)**

VD-072

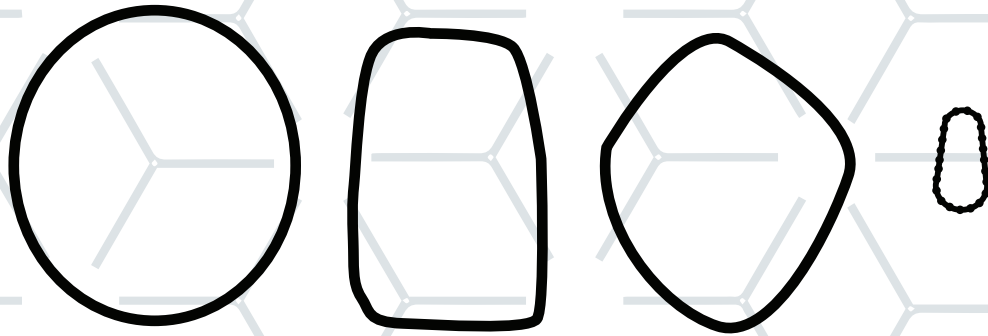

JUEGO DE LIGAS PARA ÁRBOL DE LEVAS DETROIT S-60

VD-073

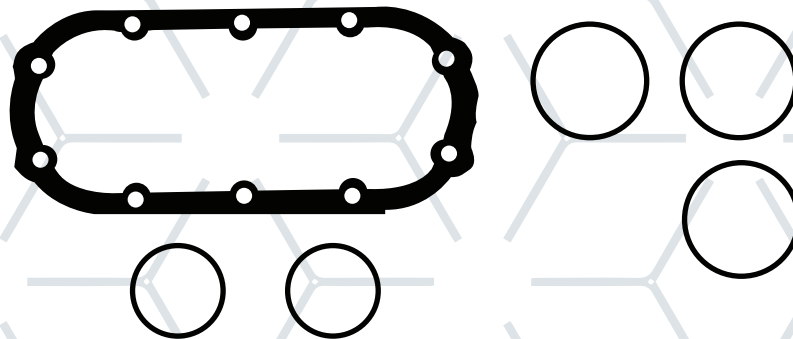

DETROIT

JUEGO PARA ENFRIADOR DE ACEITE DETROIT S-60

**VD-074**



**JUEGO DE LIGAS PARA INYECTOR DETROIT S-60**

**VD-L600**

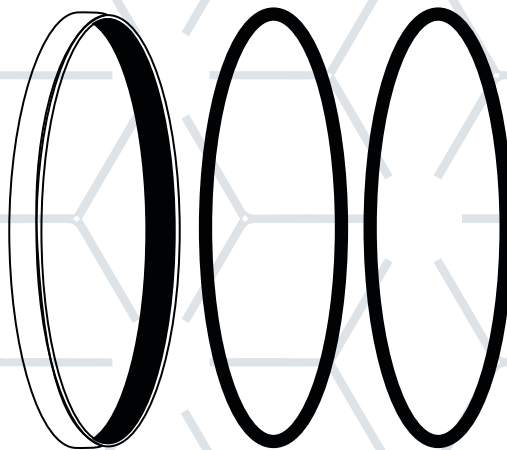

**JUEGO DE SELLO (LIGAS) PARA CAMISA DE CILINDROS DETROIT S-60**

**DETROIT**



**CJ-600-N**



**PS-600-N**



**VD-077**

DETROIT

ORIGINAL	FIRTS	APLICACIÓN
23522279	CJ-600-N	Liga Tapa de Cáster Detroit S60 DD4 NEGRA
23522269	PS-600-N	Liga Tapa de Punterías Detroit S60 DD4 NEGRA
23512048	VD-077	Juego de Ligas Bomba de Agua Detroit S-60

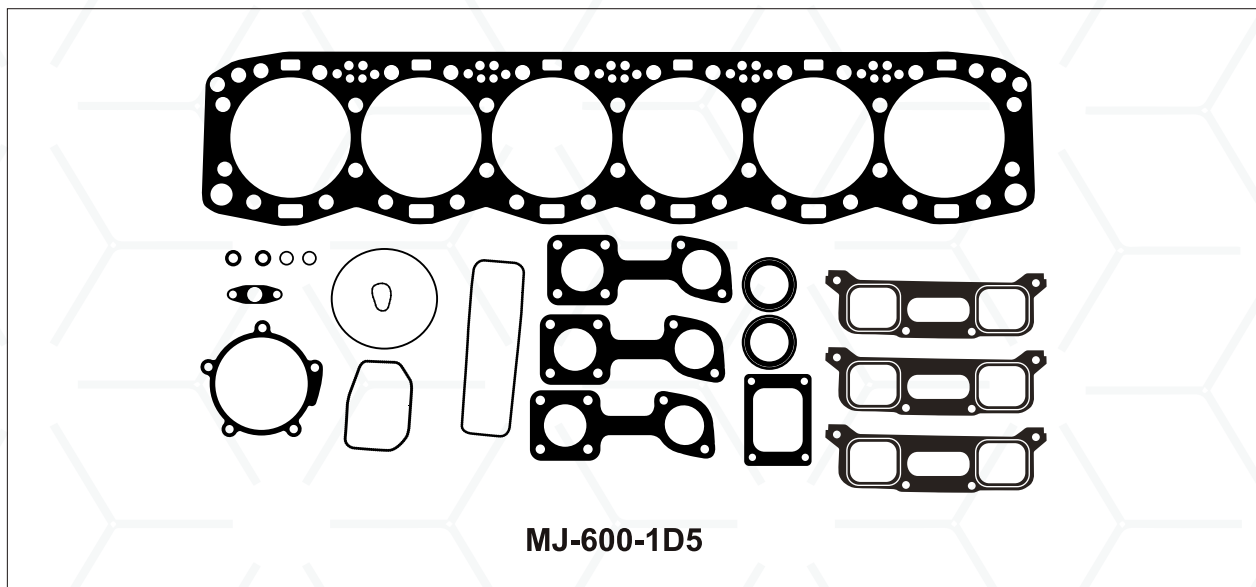
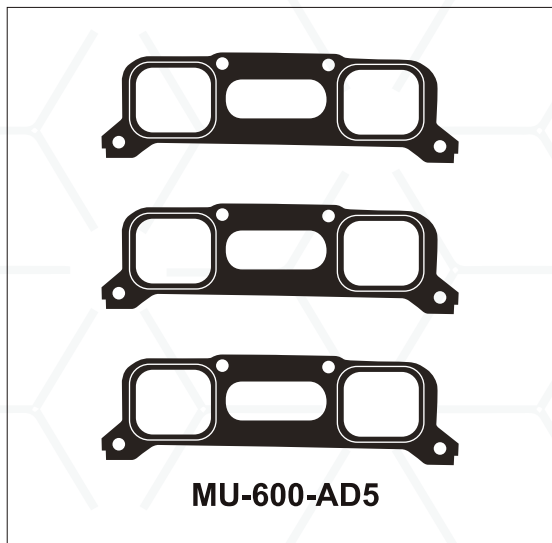
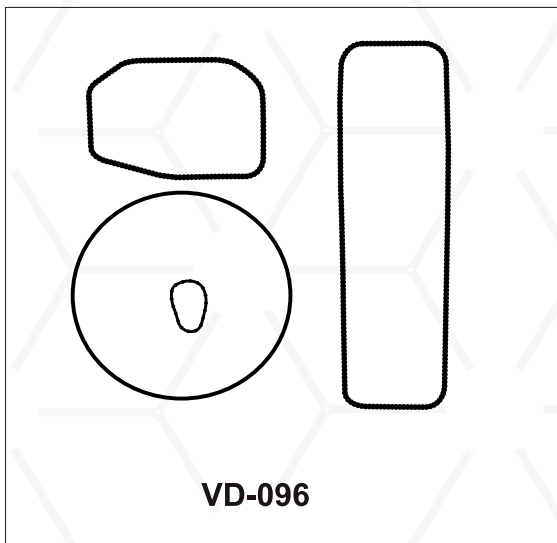

ORIGINAL	FIRTS	APLICACIÓN
23531110	VD-096	Juego de ligas de arbol de levas D-S60 DD5 14Lts.
23536442	MU-600-AD5	Juego de juntas de admisión Detroit S-60 DD5 14Lts. (3pzs.)
	MJ-600-1D5	Medio juego superior Detroit S-60 DDI5 14Lts.

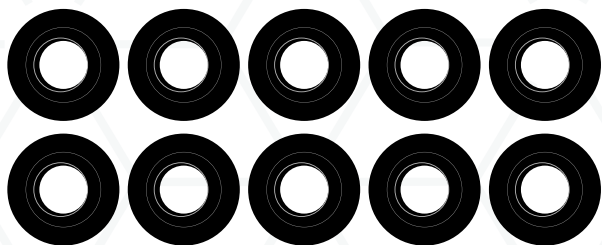

TPS-600-N

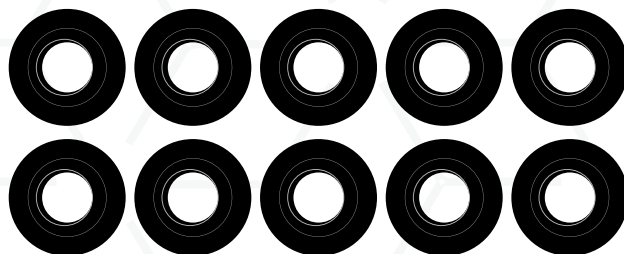

TCJ-600-N



FTP-600-G

ORIGINAL	FIRTS	APLICACIÓN
23522270	TPS-600-N	Juego soportes punteria D-S60 DD5 14Lts.
23522280	TCJ-600-N	Juego soportes carter D-S60 DD5 14Lts.
23517912	FTP-600-G	Soporte punteria S-60 grande Detroit



# CATERPILLAR

## CATERPILLAR

CATERPILLAR MOTOR 3116 Y 3126

JUEGO DE JUNTAS..... 107

PIEZAS SUELTAS ..... 109



**MJ-3116-1**  
**JUEGO SUPERIOR CATERPILLAR MOTOR 3116**

Original	Firts	Cantidad
	CA-3116	1
119-2940	PS-3126	1
119-3036	SV-3126	12
113-6200	MU-3126-E	3
7C-7431	ES-3126-T	1
4P-2684	3126-1	1
2W-7212	3126-2	1
7W-2398	3126-3	1
1S-7057	3126-4	1
7C-1159	3126-5	1
156-0235	3126-6	5
61-3033	3126-7	1
113-6250	3126-8	1
032-8970	O'RING	6
033-5853	O'RING	6
033-6042	O'RING	1
108-5803	O'RING	1
113-6003	O'RING	6
123-1199	O'RING	6
1J-9671	O'RING	3
3J-1907	O'RING	5
3K-7354	O'RING	4
3K-0360	O'RING	6
4L-9564	O'RING	1
5F-7054	O'RING	1
6F-4855	O'RING	8
6V-6228	O'RING	6
6V-8397	O'RING	2
9X-7712	O'RING	2

**CATERPILLAR**

**MJ-3126-1**  
**AL124-3684**  
**JUEGO SUPERIOR CATERPILLAR MOTOR 3126**  
**(CON CABEZA DE DOS VÁLVULAS)**

Original	Firts	Cantidad
144-3450	CA-3126	1
119-2940	PS-3126	1
119-3036	SV-3126	12
113-6200	MU-3126-E	3
7C-7431	ES-3126-T	1
4P-2684	3126-1	1
2W-7212	3126-2	1
7W-2398	3126-3	1
1S-7057	3126-4	1
7C-1159	3126-5	1
156-0235	3126-6	5
61-3033	3126-7	1
113-6250	3126-8	1
032-8970	O'RING	6
033-5853	O'RING	6
033-6042	O'RING	1
108-5803	O'RING	1
113-6303	O'RING	6
123-1199	O'RING	6
1J-9671	O'RING	3
3J-1907	O'RING	5
3K-7354	O'RING	4
3K-0360	O'RING	6
4L-9564	O'RING	1
5F-7054	O'RING	1
6F-4855	O'RING	8
6V-6228	O'RING	6
6V-8397	O'RING	2
9X-7712	O'RING	2

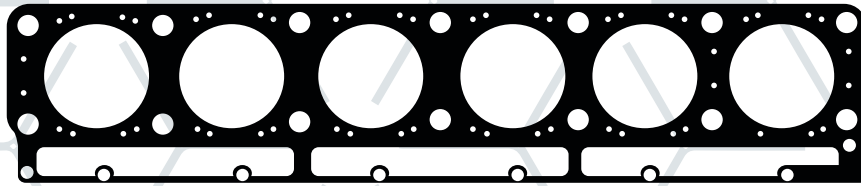

**CA-3116**

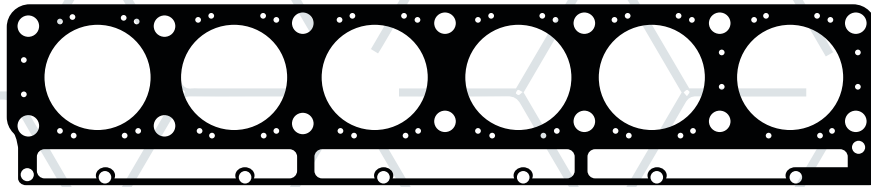

**CA-3126**

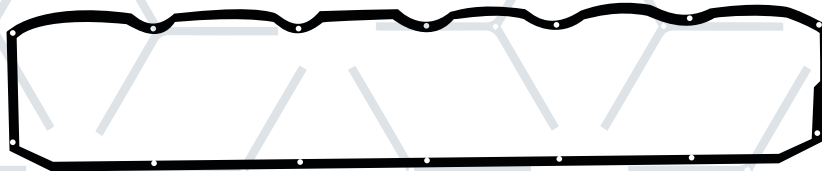

**PS-3126**

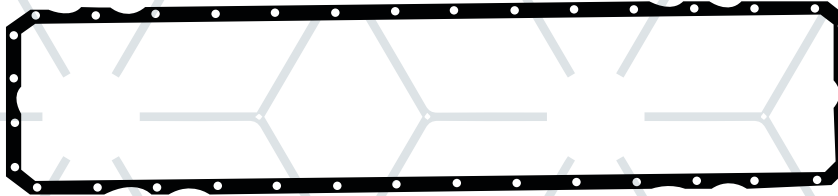

**CJ-3126**

ORIGINAL	FIRTS	APLICACIÓN
144-3450	CA-3116	Junta de Cabeza de Motor 3116
119-2940	CA-3126	Junta de Cabeza de Motor 3126
115-4202	PS-3126	Junta Tapa de Punterías
	CJ-3126	Junta de Cáster



**SV-3126**



**MU-3126-E**



**ES-3126-T**



**3126-1**



**3126-2**



**3126-3**

ORIGINAL	FIRTS	APLICACIÓN
119-3036	SV-3126	Sello de Válvula
113-6200	MU-3126-E	Junta Múltiple de Escape
7C-7431	ES-3126-T	Junta del Turbo
4P-2684	3126-1	Junta
2W-7212	3126-2	Junta
7W-2398	3126-3	Junta

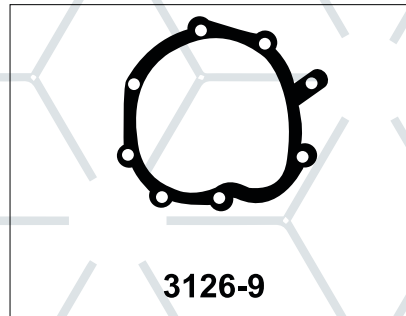
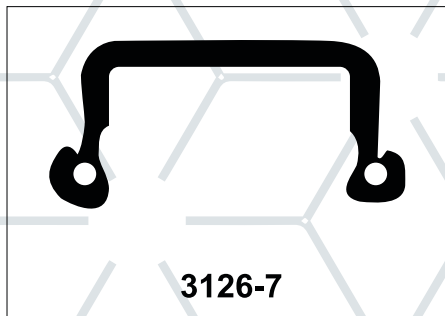
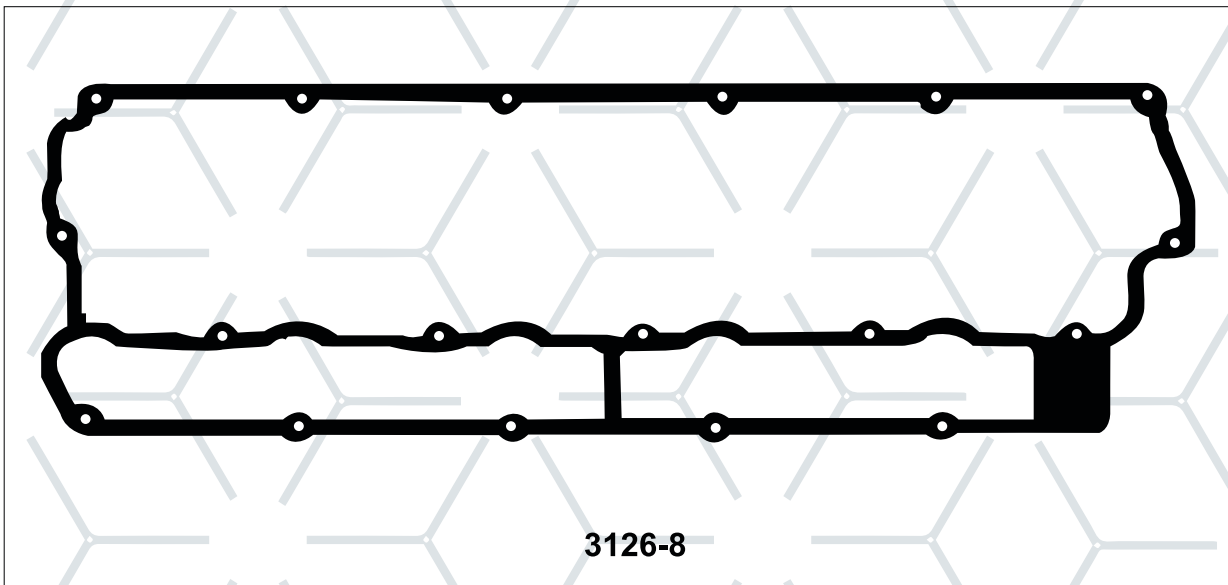
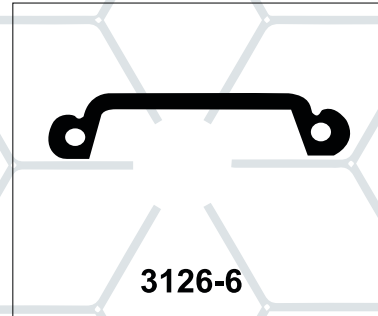
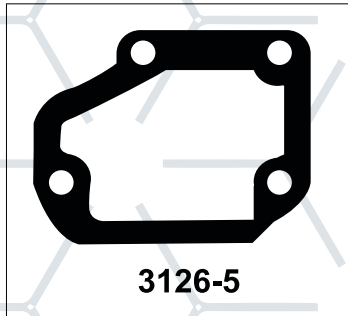
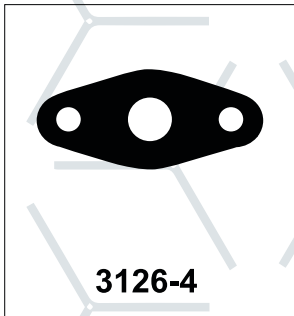

CATERPILLAR

ORIGINAL	FIRTS	APLICACIÓN
1S-7054	3126-4	Junta
7C-1159	3126-5	Junta
156-0235	3126-6	Seguro para Múltiple de Escape
GI-3033	3126-7	Seguro para Múltiple de Escape
113-6250	3126-8	Junta para Tapa de Balancines
	3126-9	Junta Bomba de Agua Caterpillar 3126





## SELLOS DE VÁLVULA

**SELLOS DE VÁLVULA .....115**

<b>SV-2104</b>	<b>Navistar 466</b>
<b>SV-2105</b>	<b>Navistar 360</b>
<b>SV-2106</b>	<b>Navistar 466 NGD</b>
<b>SV-366-A</b>	<b>MB 366 Admisión</b>
<b>SV-366-E</b>	<b>MB 366 Escape</b>
<b>SV-3126</b>	<b>Caterpillar 3116-3126</b>
<b>SV-3126-C/CH</b>	<b>Cartepillar 3126</b>
<b>SV-901</b>	<b>Dina V-6 y V-8</b>
<b>SV-907</b>	<b>Cummins N14</b>
<b>SV-600</b>	<b>Detroit S-60</b>
<b>SV-ISX</b>	<b>Cummins ISX</b>
<b>SV-L10</b>	<b>Cummins L10</b>
<b>SV-MB-904</b>	<b>MB 904-906</b>



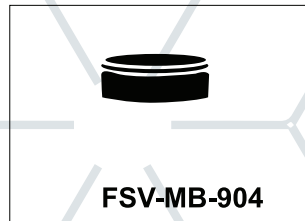
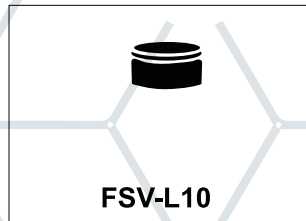
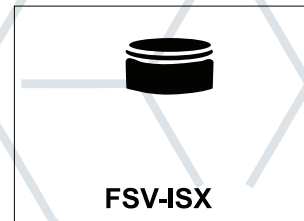
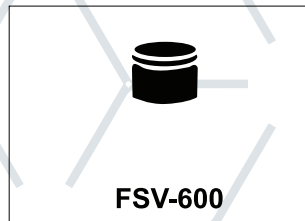
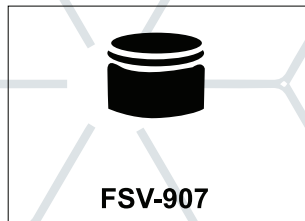
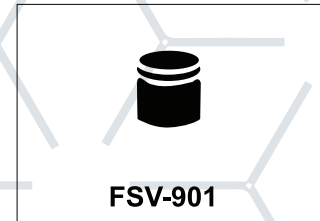
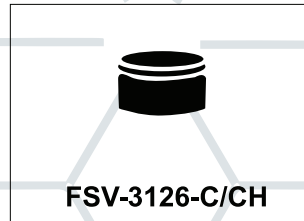
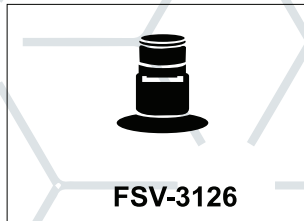
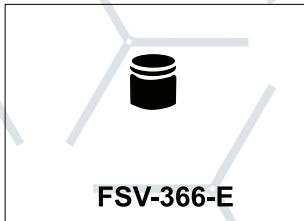
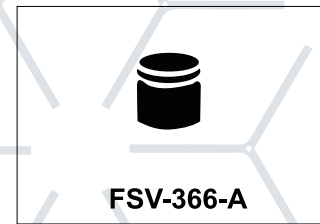
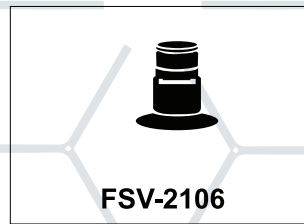
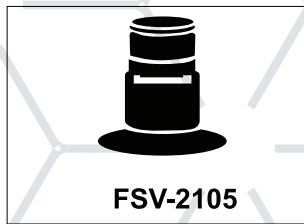
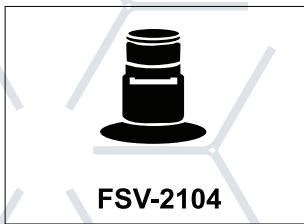

SELLOS DE VÁLVULA

ORIGINAL	FIRTS	APLICACIÓN
	SV-2104	Sello de válvula Navistar 466
	SV-2105	Sello de válvula Navistar 360
	SV-2106	Sello de válvula Navistar 466 NGD
	SV-366-A	Sello de válvula MB 366 Admisión
	SV-366-E	Sello de válvula MB 366 Escape
	SV-3126	Sello de válvula Caterpillar 3116-3126
	SV-3126-C/CH	Sello válvula Caterpillar 3126
	SV-901	Sello de válvula Dina V6 y V8
	SV-907	Sello de válvula Cummins N14
	SV-600	Sello de válvula Detroit S-60
	SV-ISX	Sello de válvula Cummins ISX
	SV-L10	Sello de válvula Cummins L10
	SV-MB-904	Sello de válvula MB 904-906



## TRANSMISIONES

**TRANSMISIONES..... 119**

<b>TS-001</b>	<b>Dina Serie 500-531</b>
<b>TS-002</b>	<b>Dina Serie 600-631</b>
<b>TS-003</b>	<b>Dodge, Chevrolet, Tremec / Clark</b>
<b>TS-006</b>	<b>Spicer Fase I</b>
<b>TS-007</b>	<b>Fuller Fase I</b>
<b>TS-008</b>	<b>Fuller Fase II</b>
<b>TS-009</b>	<b>Dina Serie 600-631</b>
<b>TS-011</b>	<b>Spicer Fuller II</b>
<b>TS-006/0011</b>	<b>Spicer Fase I y II</b>
<b>TS-024</b>	<b>Mercedes Benz Clark</b>
<b>TS-025</b>	<b>Fuller 18 Velocidades</b>
<b>TS-026</b>	<b>Fuller FS-6205, 6305, 5306</b>
<b>TS-027</b>	<b>Fuller Ref. k-7030</b>
<b>TS-028</b>	<b>Fuller Súper 10 14610A, 11610B</b>
<b>TS-029</b>	<b>Jgs Juntas FULLER 11613, 12513, RTO906, 910, 915, 11610B, 16718</b>
<b>TS-030</b>	<b>Sello Aceite Fuller Ref. K-2918</b>
<b>TS-031</b>	<b>Sello Aceite Fuller Ref. K-2252</b>
<b>TS-032</b>	<b>Cambio de Aire Ref. TG-GSK-A</b>
<b>TS-033</b>	<b>Transmisión Microbús Vochobus</b>
<b>TS-034</b>	<b>Transmisión Fuller 18 Vel. Ref. K-3288</b>
<b>TS-035</b>	<b>Transmisión Fuller Súper 10 Nuevo K-2921</b>
<b>TS-036</b>	<b>Transmisión Fuller 18 Vel. Nuevo K-910, 913, 915</b>



TS-001

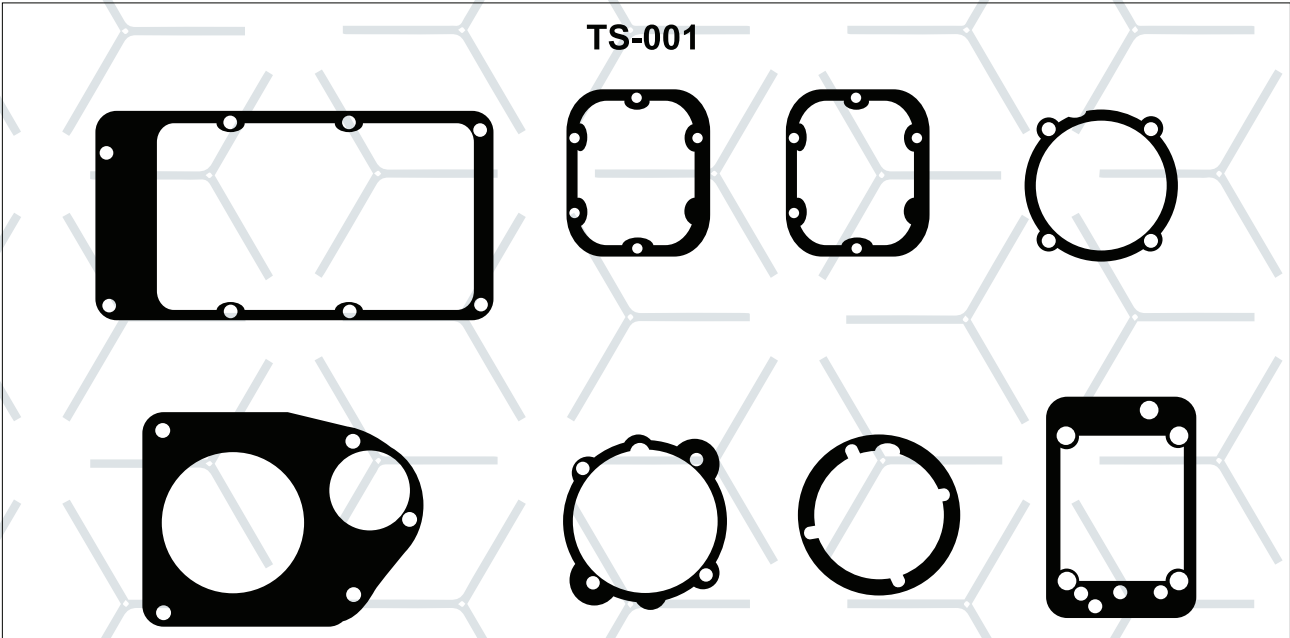

JUEGO DE JUNTAS DE TRANSMISIÓN DINA SERIE 500-531  
V6 155 HP No. REFERENCIA 14414-07

TS-002

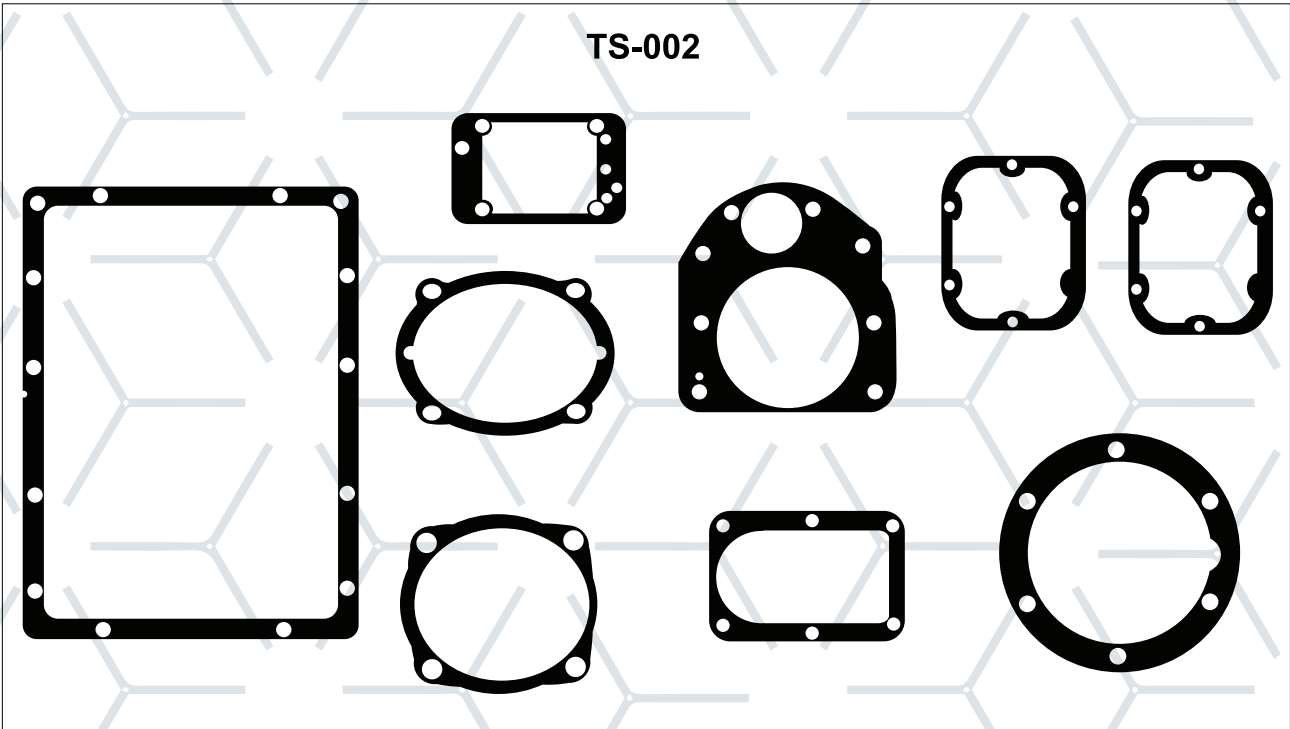

JUEGO DE JUNTAS DE TRANSMISIÓN DINA SERIE 600-631  
No. REFERENCIA 17414-07 V8 210 HP

**TS-003**

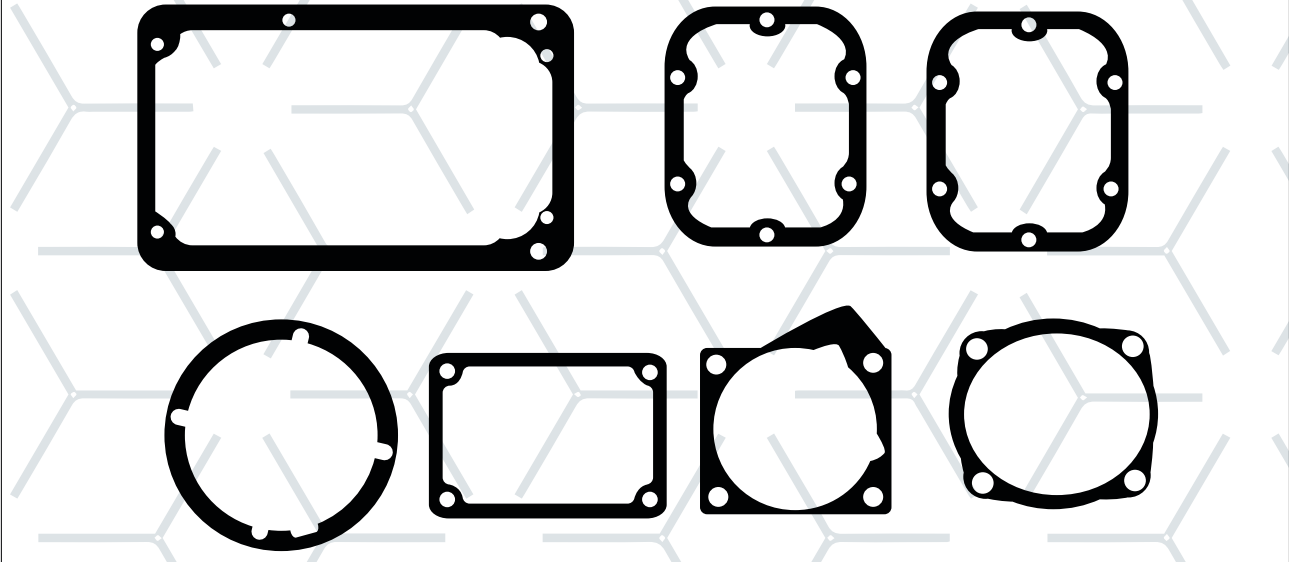

**JUEGOS DE JUNTAS DE TRANSMISIÓN DODGE, CHEVROLET, TREMEC / CLARK  
5 VELOCIDADES**

**TS-006**

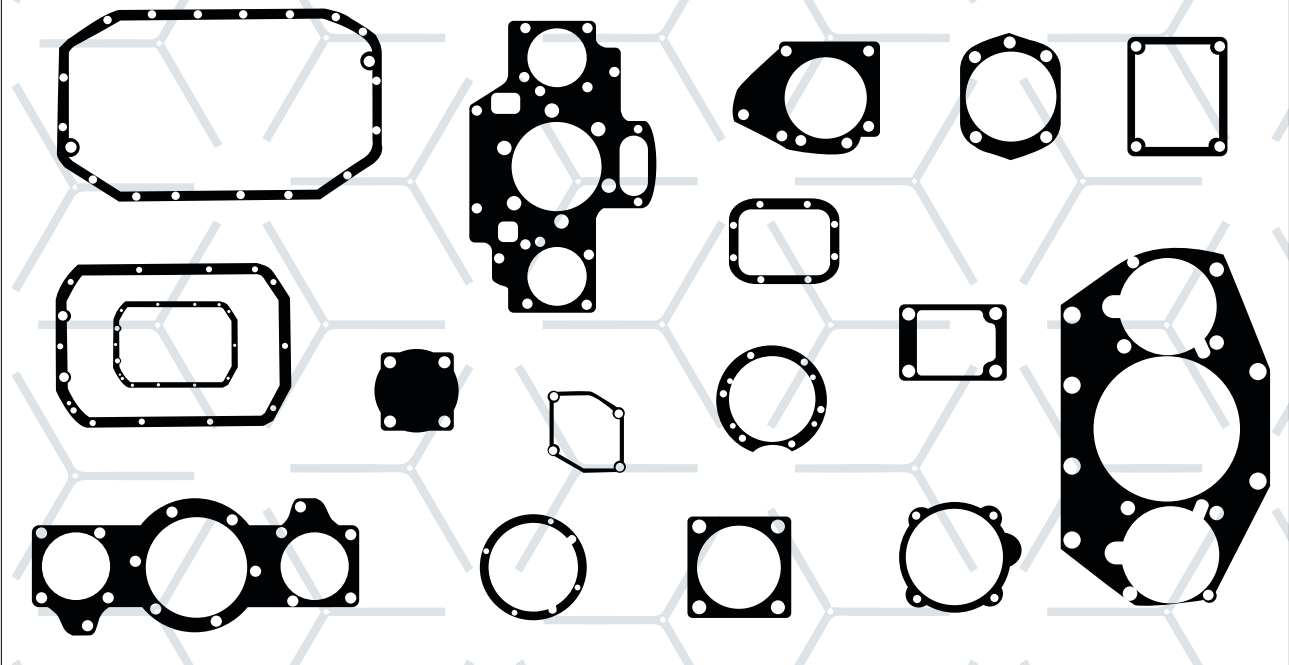

**JUEGOS DE JUNTAS DE TRANSMISIÓN SPICER FASE I  
No. ORIGINAL 312475-17 X SST-20**

TS-007

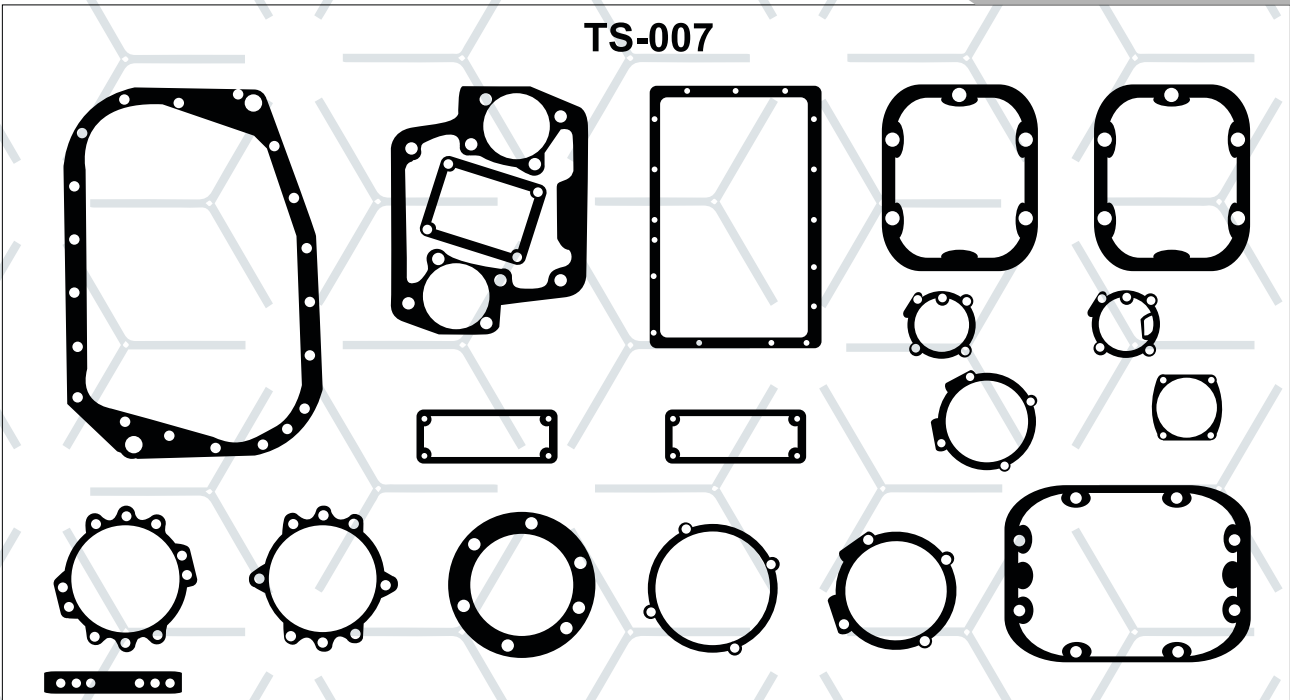

JUEGO DE JUNTAS DE TRANSMISIÓN FULLER FASE I 910-915 (K-1094)

TS-008

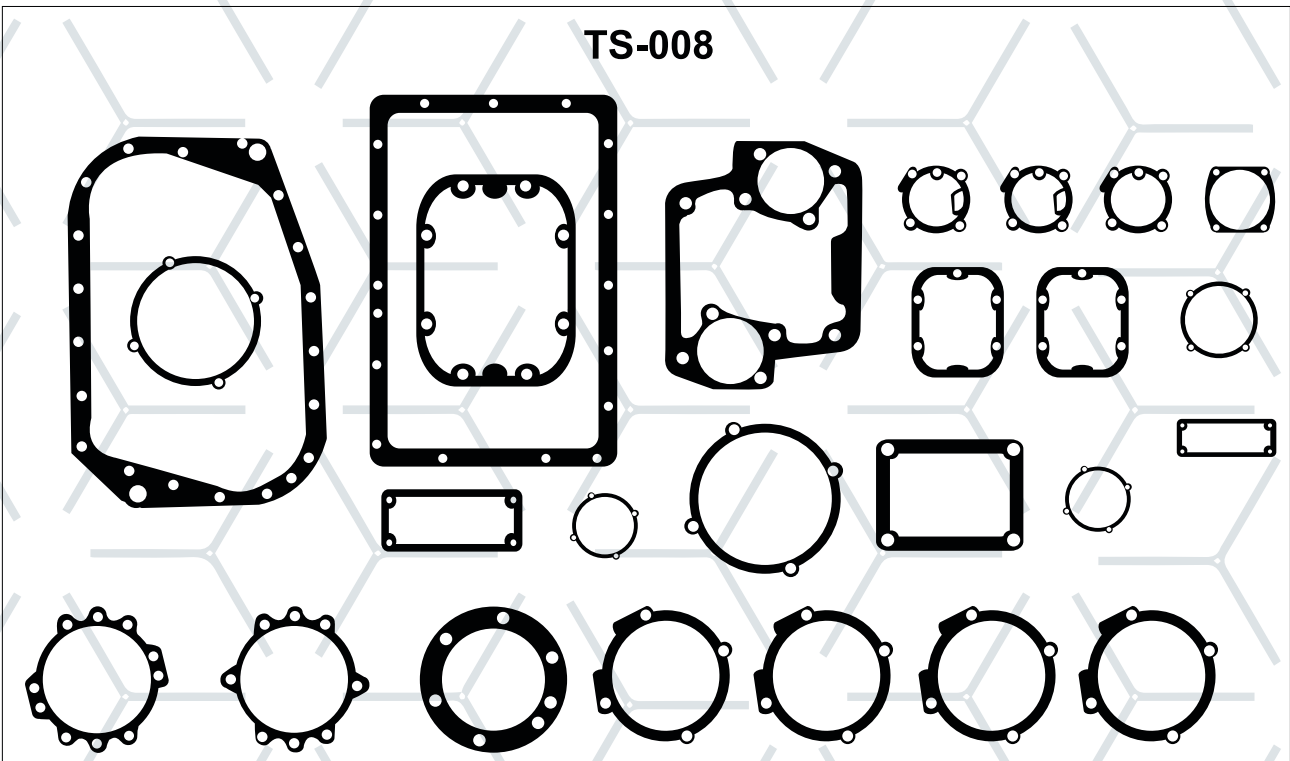

JUEGO DE JUNTAS DE TRANSMISIÓN FULLER FASE II 12515 (K-1009)

**TS-009**

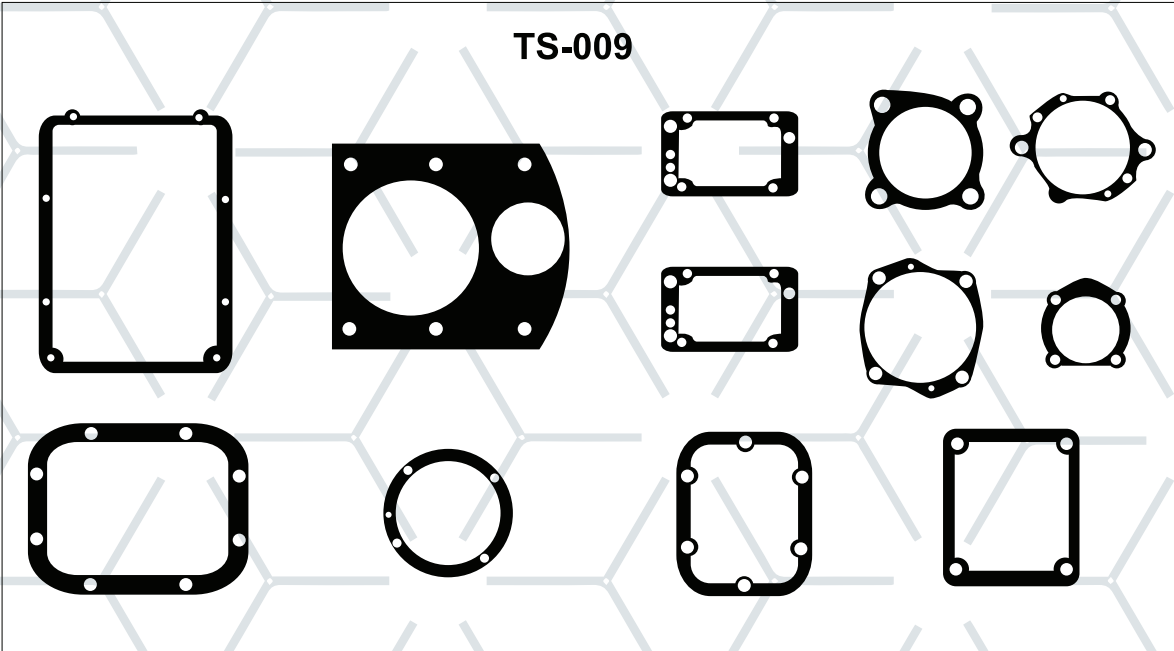

**JUEGO DE JUNTAS DE TRANSMISIÓN DINA SERIE 600-631 312475-28X TIPO NUEVO**

**TS-011**

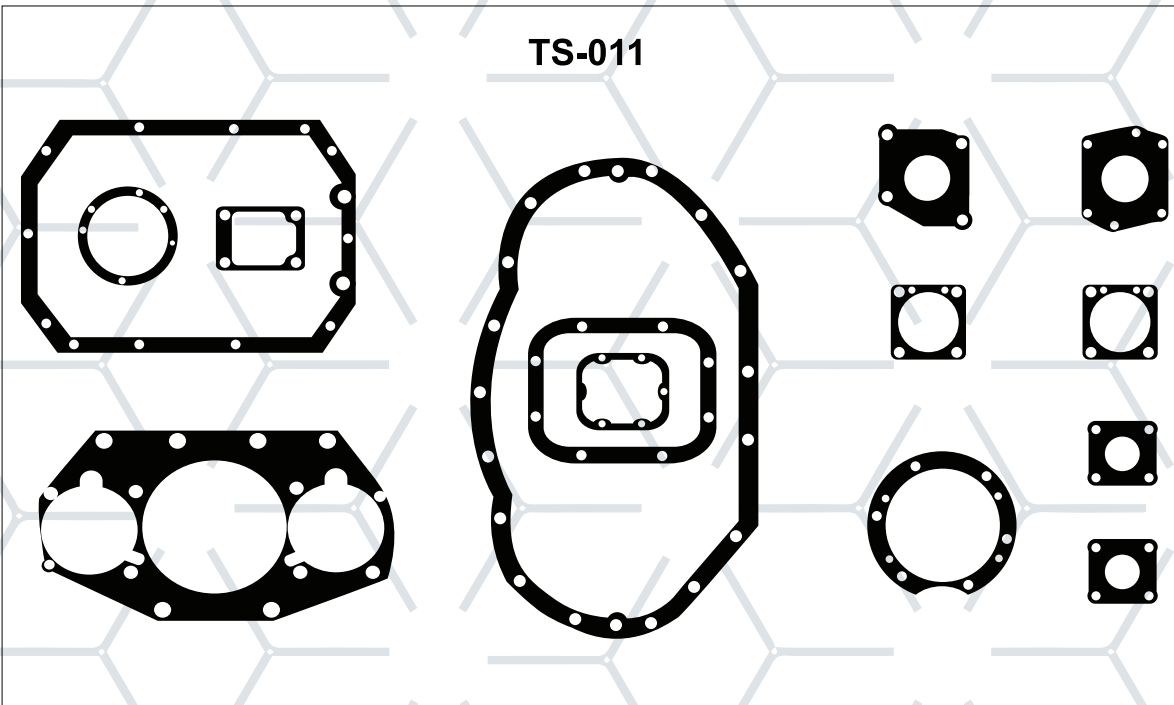

**JUEGO DE JUNTAS DE TRANSMISIÓN SPICER FASE II 312475 7 AX**





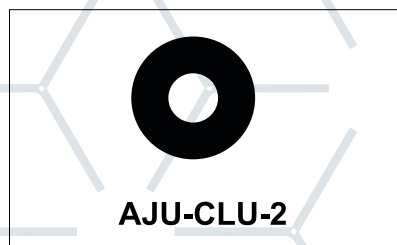
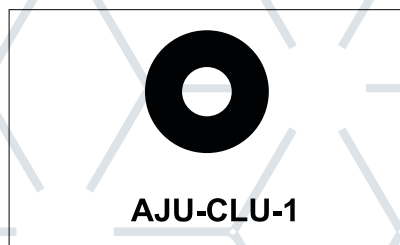
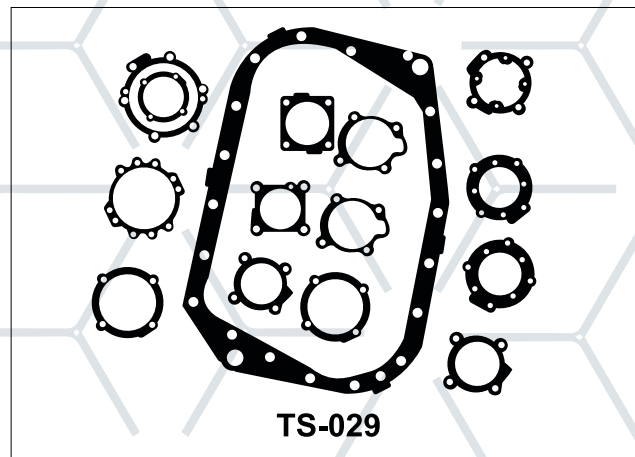
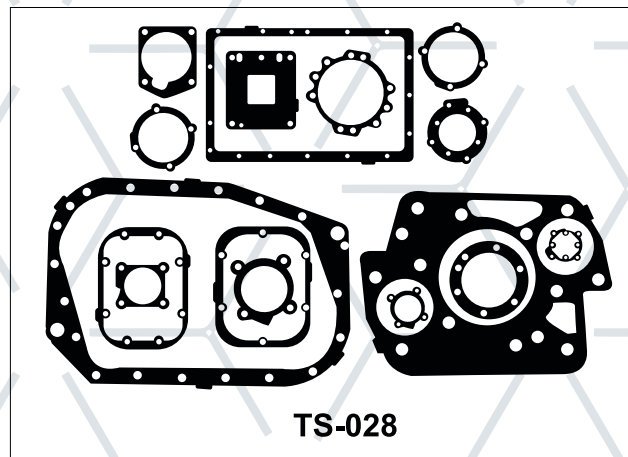
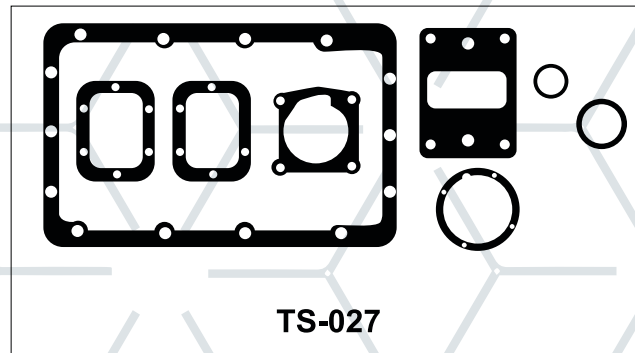
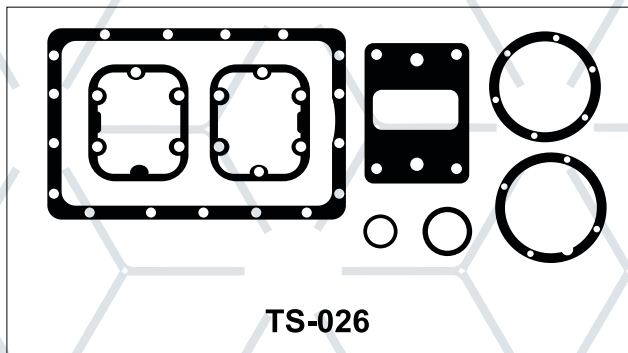

TRANSMISIONES

ORIGINAL	FIRTS	APLICACIÓN
K-7028	TS-026	Juego Juntas FULLER FS-6205,6305,5360,6306
K-7030	TS-027	Juego Juntas FULLER
K-2295	TS-028	Jgs Juntas FULLER super 10,14610A,11610B,13610B,14610B,16610B
K-1603	TS-029	Jgs Juntas FULLER 11613,12513,RTO906,910,915,11610B,16718
125-C-40	AJU-CLU-1	Junta Roldana P/Ajuste Clutch 13/4"
125-C-41	AJU-CLU-2	Junta Roldana P/Ajuste Clutch 2"

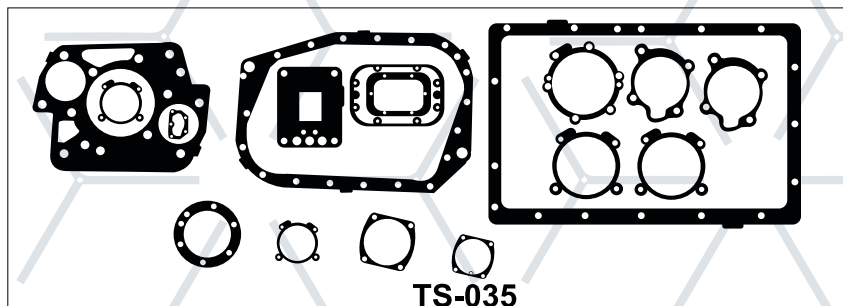
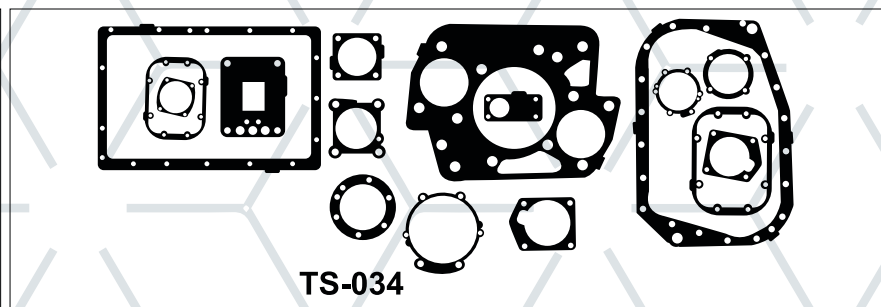
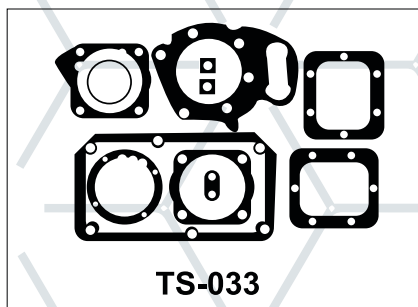
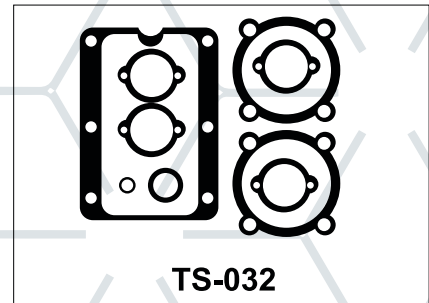
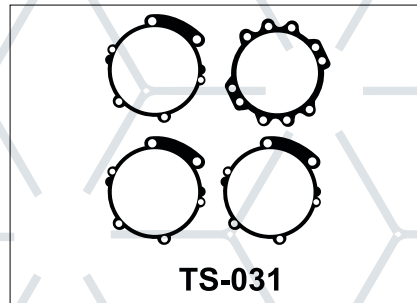
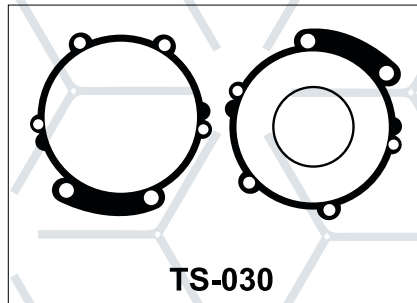

TRANSMISIONES

ORIGINAL	FIRTS	APLICACIÓN
K-2918	TS-030	Juego de Juntas sello aceite Fuller Ref. K-2918
K-2262	TS-031	Juego de Juntas sello aceite Fuller Ref. K-2262
TG-GSK-A	TS-032	Juego de Juntas cambio de Aire Ref. TG-GSK-A
FV-350	TS-033	Juego de Juntas Transmisión Microbus Vochobus
K-3288	TS-034	Juego de Juntas Transmisión Fuller 18 Vel. Ref. K-3288
K-2921	TS-035	Juego de Juntas Transmisión Fuller Super 10 Nuevo

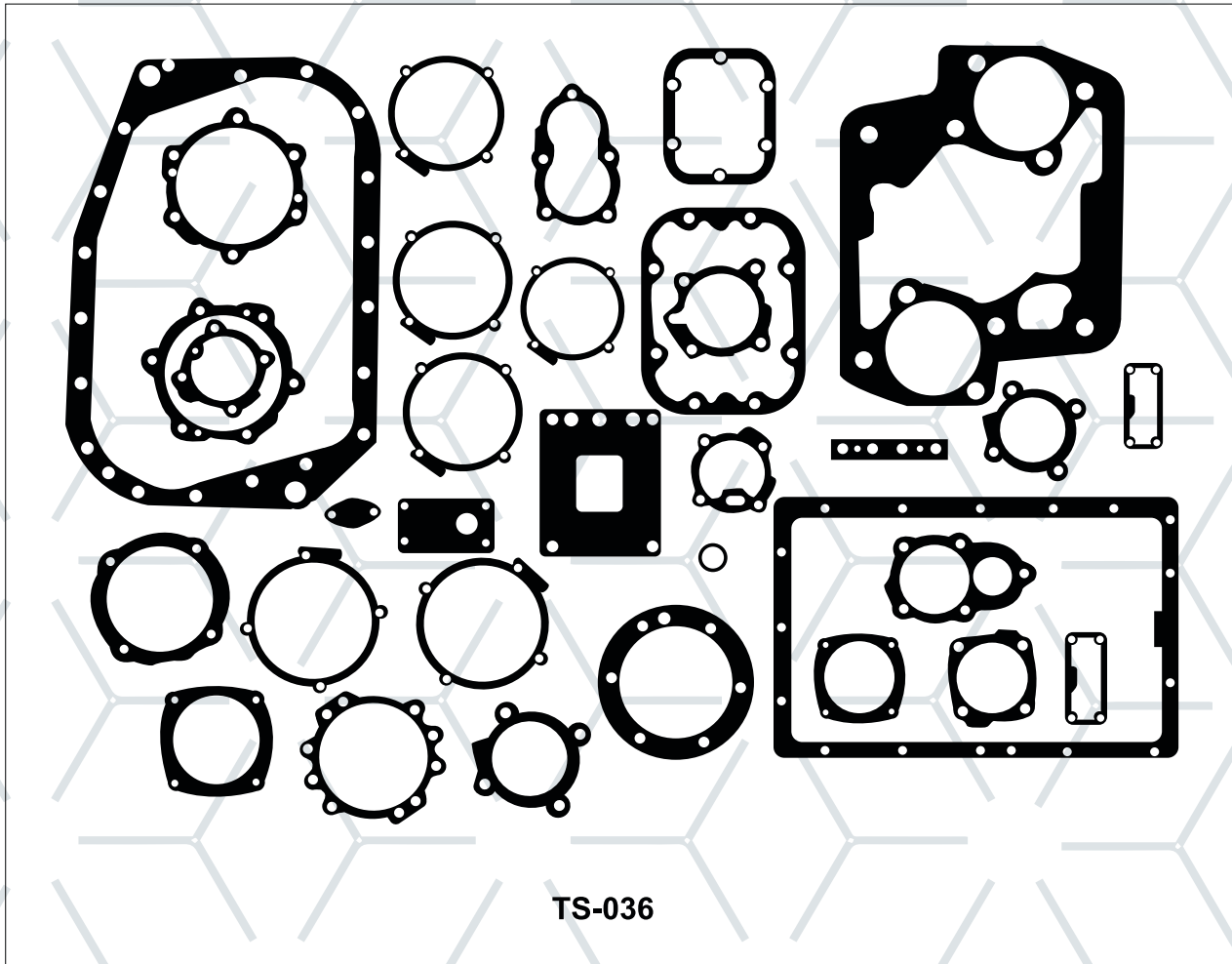

JUEGO DE JUNTAS TRANSMISIÓN FULLER REF-K-910, 913, 615, 147, 15

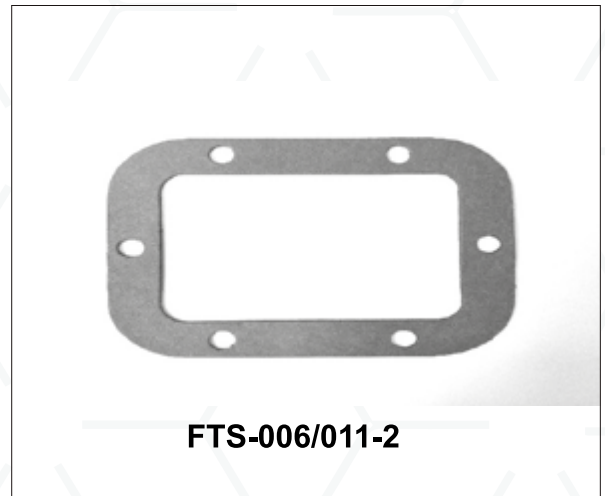
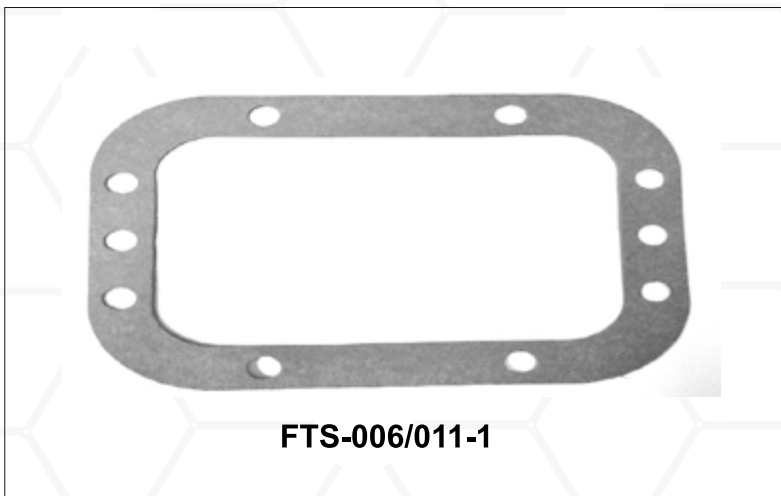
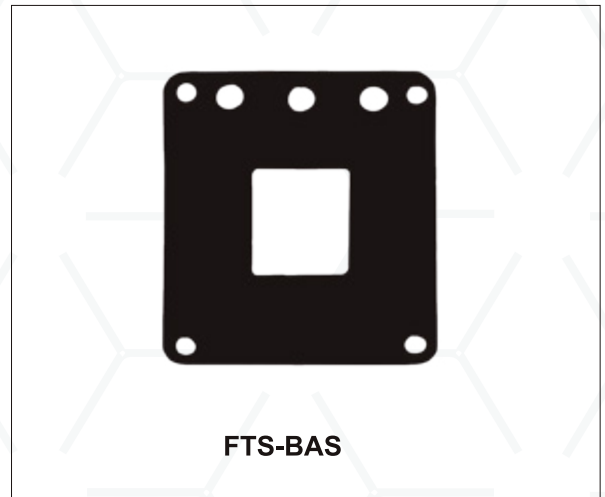
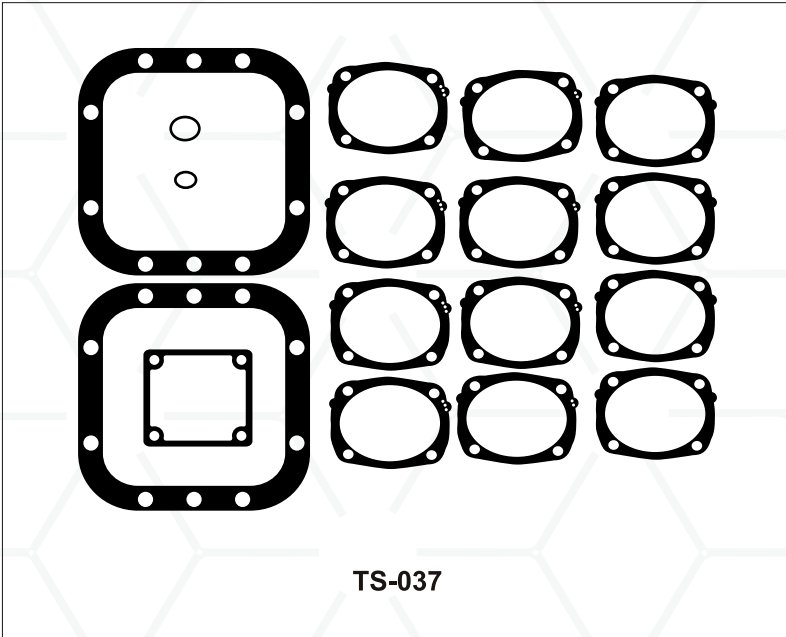

ORIGINAL	FIRTS	APLICACIÓN
	TS-037	Juego de juntas toma de fuerza transmisiones
	FTS-BAS	Junta Bastón de transmisión
	FTS-006/011-1	Junta Toma de Fuerza Transmisiones Grande
	FTS-006/011-2	Junta Toma de Fuerza Transmisiones Chico 6 Orificios



## DIFERENCIALES

**VARIOS DIESEL..... 131**

**DF-001 Dina Serie 500-531**

**DF-002 Dina Serie 600-3-631**

**DF-012 Delantero K-4861**

**DF-013 Trasero SHD K-487**



DF-001

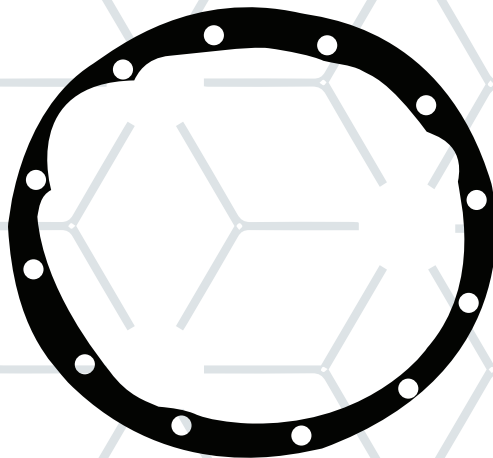

JUNTAS DIFERENCIAL DINA SERIE 500-531 88218-09

DF-002



JUNTAS DIFERENCIAL DINA SERIE 600-631 245218-09

**DF-012**

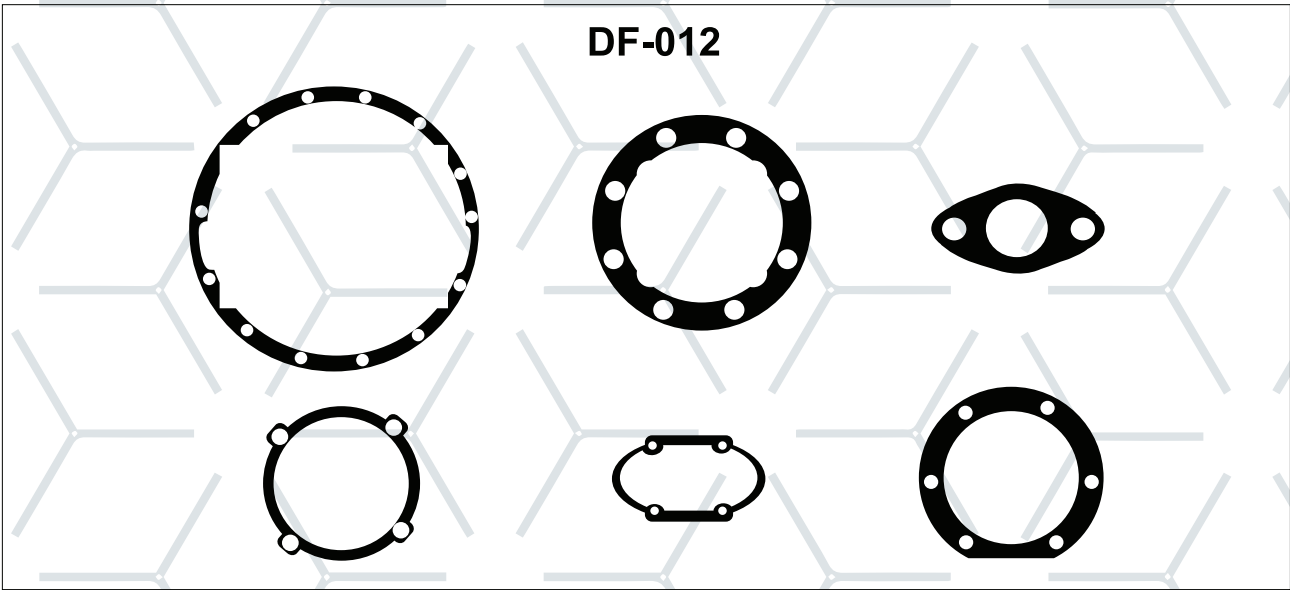

**DINA JUEGO DE JUNTAS DIFERENCIAL DELANTERO SHD K-4861**

**DF-013**

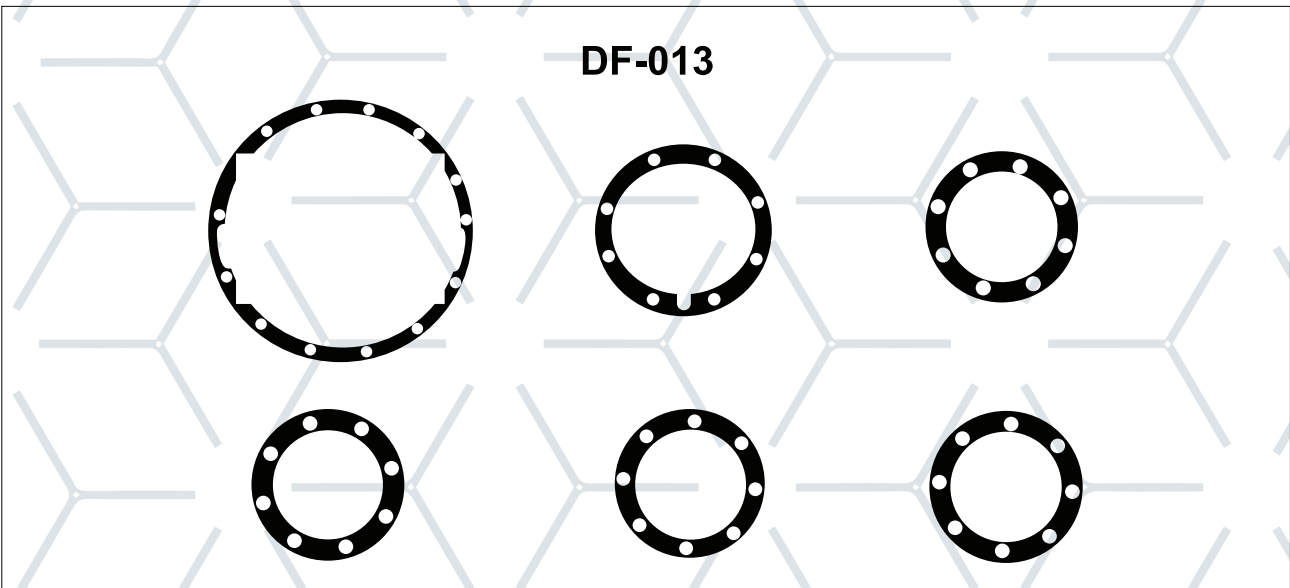

**DINA JUEGO DE JUNTAS DIFERENCIAL TRASERO SHR K-487**

## COMPRESORES

**COMPRESORES ..... 135**

<b>VD-001</b>	<b>TU-FLO 400</b>
<b>VD-002</b>	<b>TU-FLO 500</b>
<b>VD-009</b>	<b>TU-FLO 501</b>
<b>VD-012</b>	<b>Dina Cummins</b>
<b>VD-012-3</b>	<b>Dina Cummins</b>
<b>VD-012-4</b>	<b>Dina Cummins</b>
<b>VD-012-350</b>	<b>Cummins 350</b>
<b>VD-055</b>	<b>Midland tipo EL 740,2"</b>
<b>VD-056</b>	<b>Midland tipo EL 1300 / 1600,2"3/4</b>
<b>VD-057</b>	<b>Mercedes Benz</b>
<b>VD-058</b>	<b>Knorr 150 C.C.</b>
<b>VD-059</b>	<b>Bendix</b>
<b>VD-060</b>	<b>Knorr Combinado Mediano</b>
<b>VD-061</b>	<b>Wabco Grande</b>
<b>VD-062</b>	<b>Wabco Chico</b>
<b>VD-064</b>	<b>Bendix</b>
<b>VD-079</b>	<b>Compresor Electrónico N14</b>
<b>VD-080</b>	<b>Compresor Wabco Doble Pistón para Volvo</b>
<b>VD-081</b>	<b>Compresor York</b>
<b>VD-082</b>	<b>Cabeza Compresor Brasileña</b>
<b>VD-083</b>	<b>Compresor Wabco-Knorr</b>
<b>VD-084</b>	<b>Compresor Mult-60 Cabeza Volada (412352005)</b>
<b>VD-085</b>	<b>Compresor Wabco Doble Pistón para Mercedes Benz</b>
<b>VD-086</b>	<b>Compresor Cabeza Volada Volvo Wabco</b>
<b>VD-087</b>	<b>Compresor Bendix Doble Pistón</b>
<b>VD-088</b>	<b>Compresor Wabco Doble Pistón Mercedes Benz</b>
<b>VD-089</b>	<b>Compresor Wabco Doble Pistón Volvo</b>
<b>VD-090</b>	<b>Compresor Wabco Doble Pistón Enfriado por Agua</b>



**VD-001**

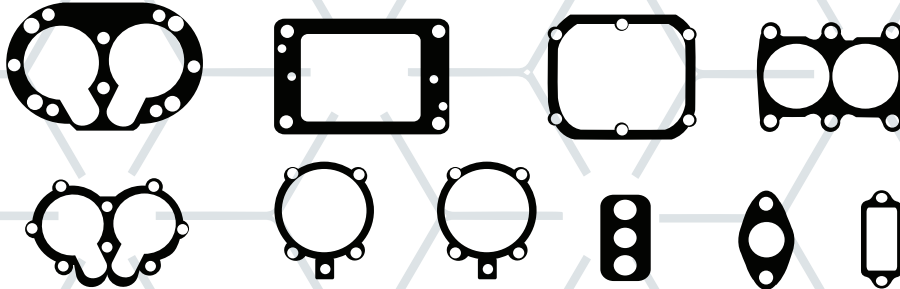

**JUEGO DE JUNTAS PARA COMPRESOR TU-FLO 400 / 229416  
No. 279712 MOTOR GASOLINA Y/O PERKINS**

**VD-002**

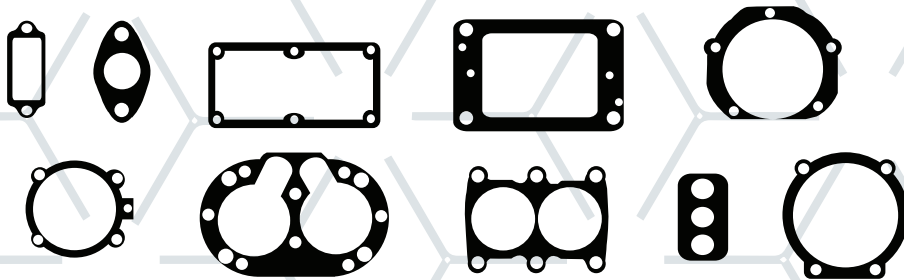

**JUEGO DE JUNTAS PARA COMPRESOR TU-FLO 500 / 229417 No. 276962  
MOTOR GM DIESEL Y/O CUMMINS DIESEL**

**VD-009**

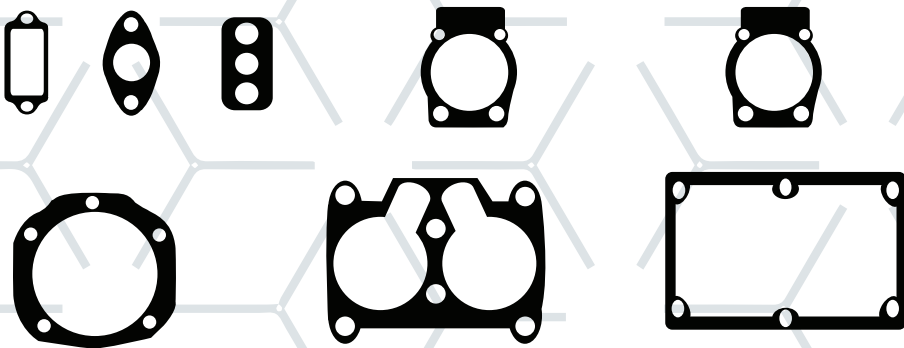

**JUEGO DE JUNTAS PARA COMPRESOR TU-FLO 501/287043  
MOTOR CUMMINS DIESEL, GM DIESEL Y PERKINS DIESEL**

**COMPRESORES**

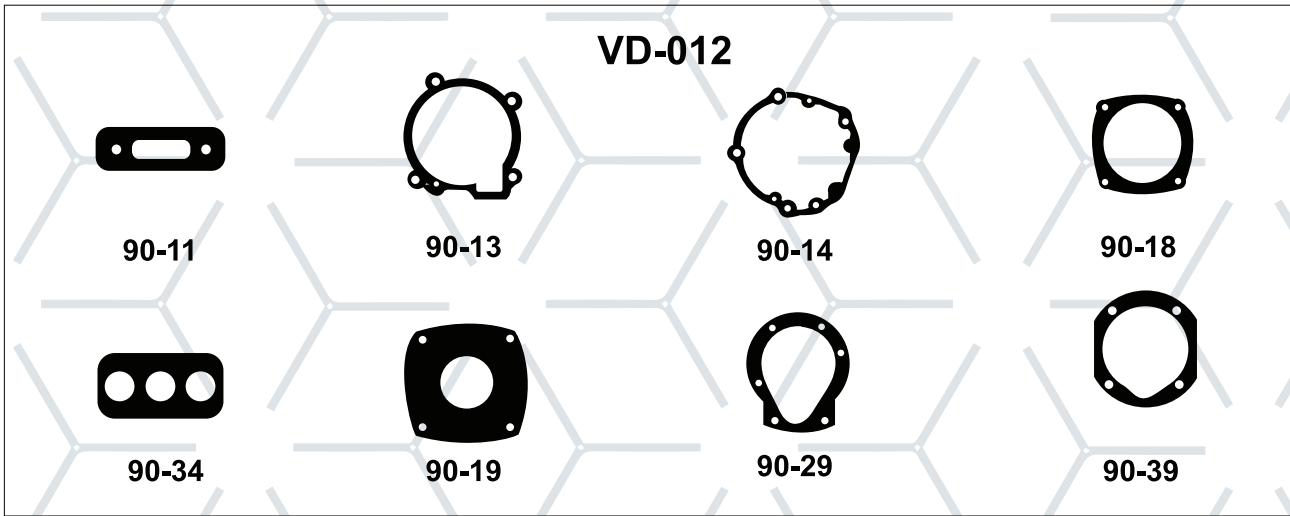

JUEGO DE JUNTAS PARA COMPRESOR CUMMINS AR / 12719 MOTOR V6 140-155 HP Y V8 185-210 HP

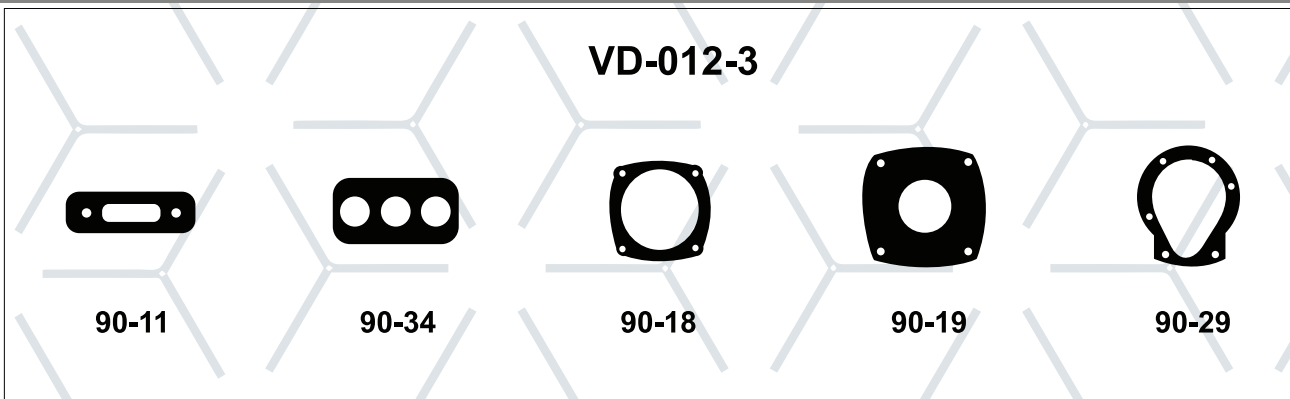

JUEGO DE JUNTAS PARA COMPRESOR CUMMINS AR / 12719 MOTOR V6 140-155 HP Y V8 185-210 HP

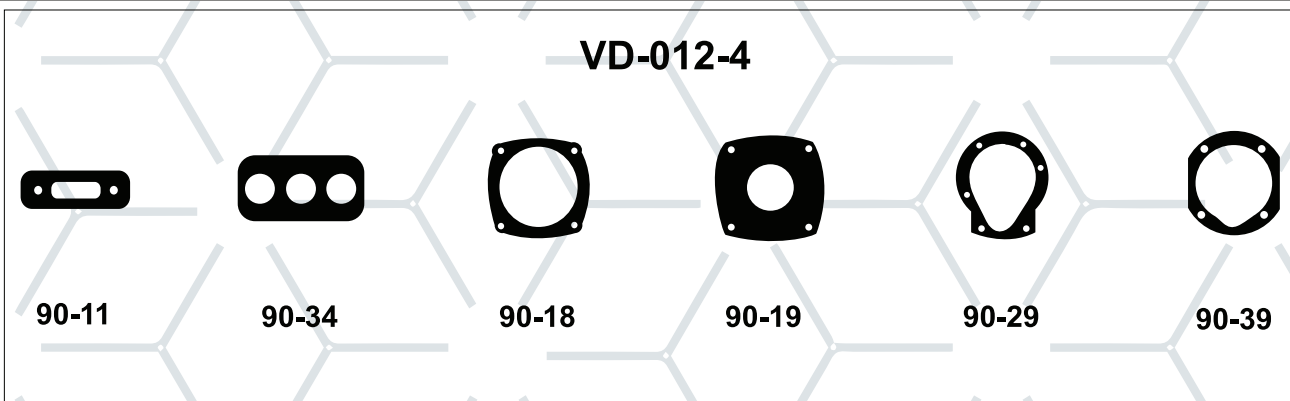

JUEGO DE JUNTAS PARA COMPRESOR CUMMINS AR / 12719 MOTOR V6 140-155 HP Y V8 185-210 HP

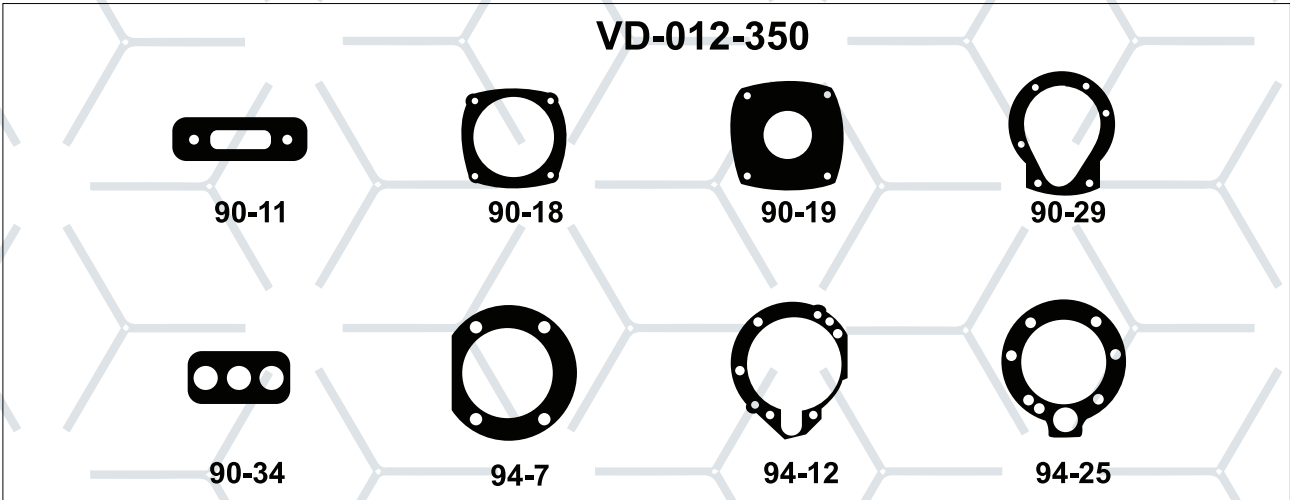

**JUEGO DE JUNTAS PARA COMPRESOR CUMMINS MOTOR NTC-350**

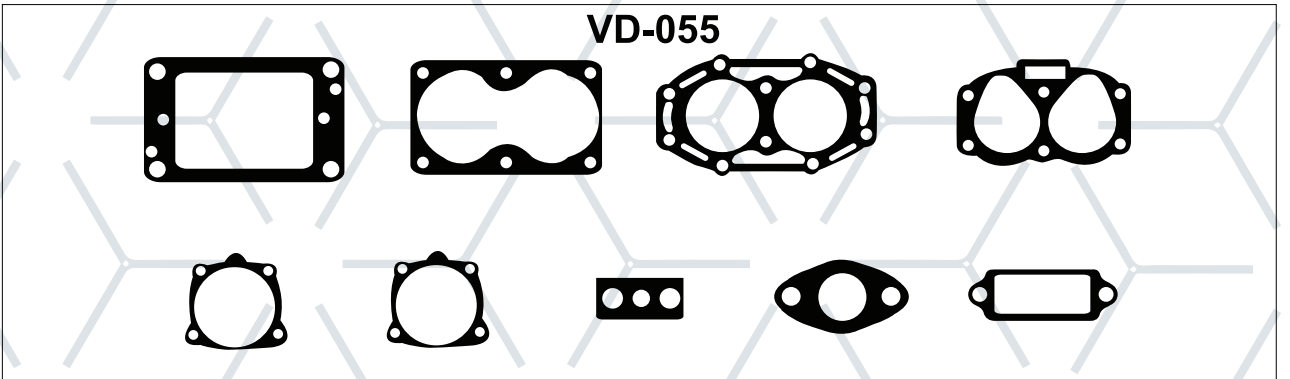

**JUEGO DE JUNTAS PARA COMPRESOR MIDLAND 2" TIPO EL-740 / RN26DW**

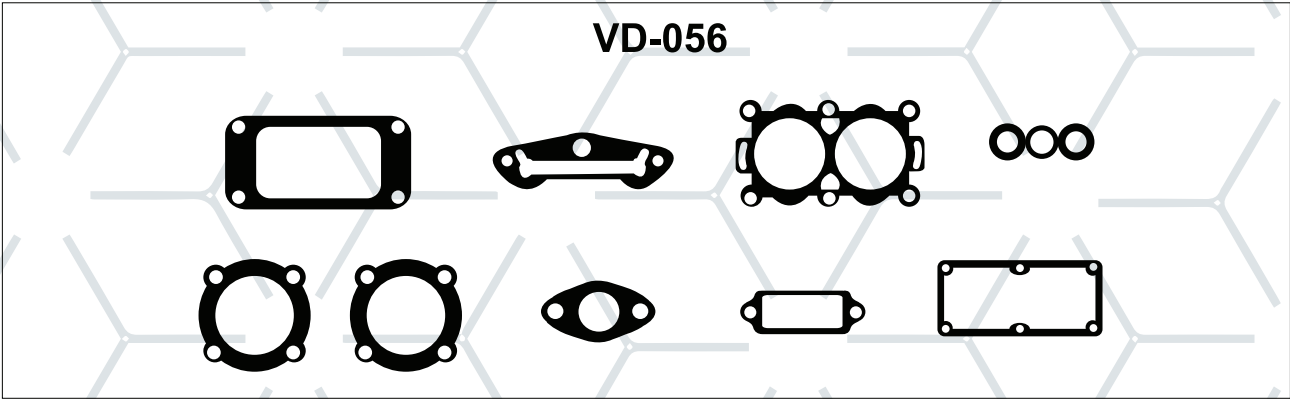

**JUEGO DE JUNTAS PARA COMPRESOR MIDLAND TIPO EL-1300 / RNT26, EL13020 2" 3/4**

**COMPRESORES**

**VD-057**

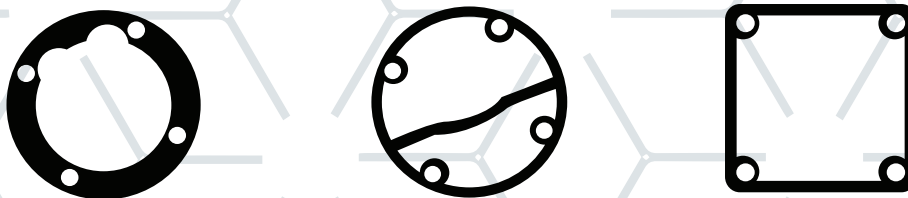

JUEGO DE JUNTAS PARA COMPRESOR WABCO W-220 ENFRIADO POR AGUA (MERCEDES BENZ)

**VD-058**

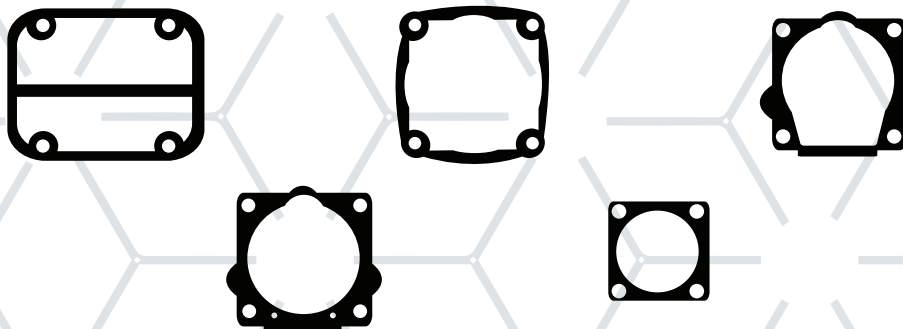

JUEGO DE JUNTAS PARA COMPRESOR KNORR 150 C. C. No. 1310501 (MINIBUS MERCEDES BENZ)

**VD-059**

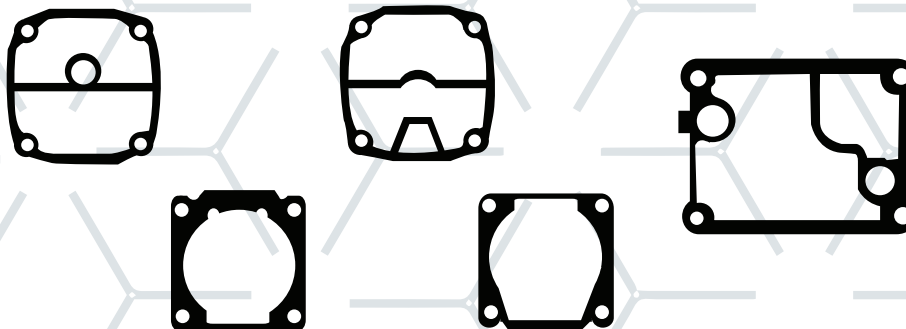

JUEGO DE JUNTAS PARA COMPRESOR BENDIX 1186736 190 C. C. No. 1189085 (MERCEDES BENZ)

**VD-060**

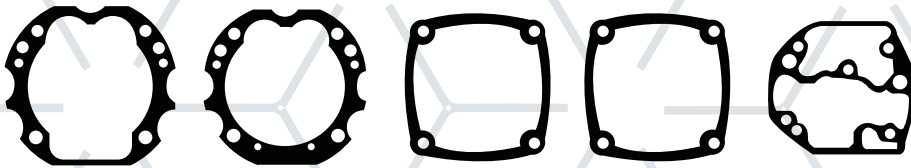

**JUEGO DE JUNTAS PARA COMPRESOR KNORR 220 ENFRIADO POR AGUA (MERCEDES BENZ)**

**VD-061**

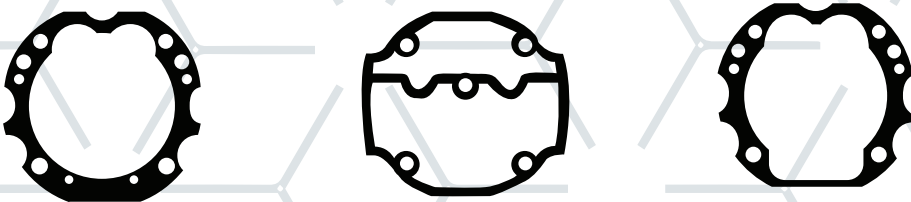

**JUEGO DE JUNTAS PARA COMPRESOR WABCO 220 (MERCEDES BENZ)**

**VD-062**

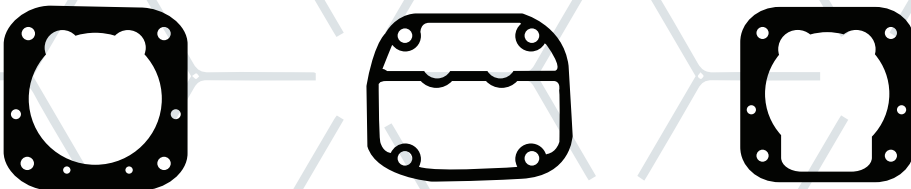

**JUEGO DE JUNTAS PARA COMPRESOR WABCO 159 (MERCEDES BENZ)**

**VD-064**

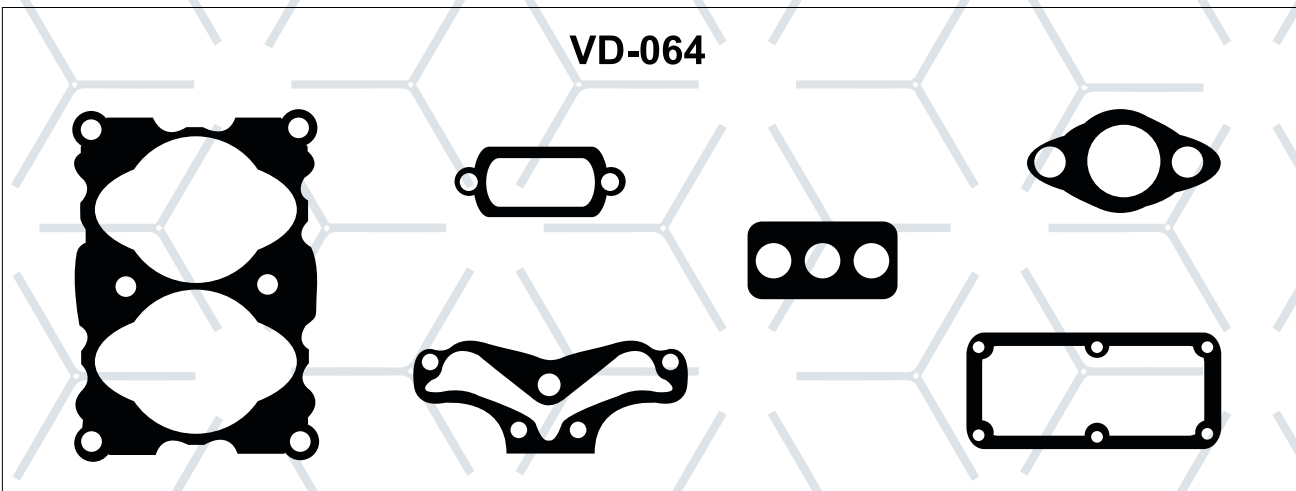

**JUEGO DE JUNTAS PARA COMPRESOR BENDIX TU-FLO 550-750 No. 107516 Y No. 65457**

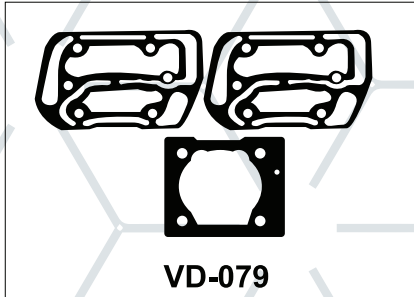

VD-079

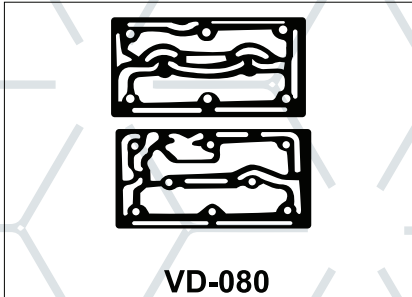

VD-080

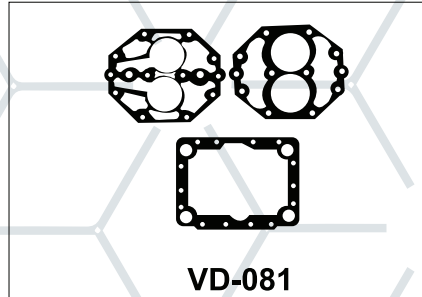

VD-081

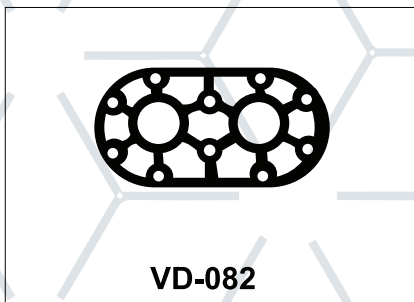

VD-082



VD-083

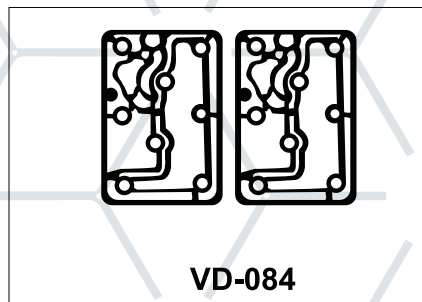

VD-084

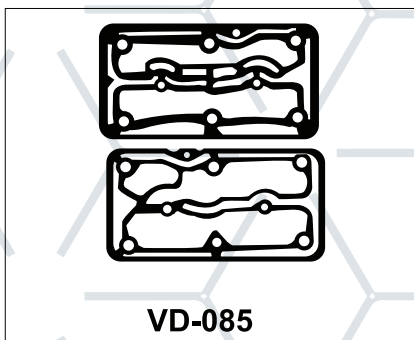

VD-085

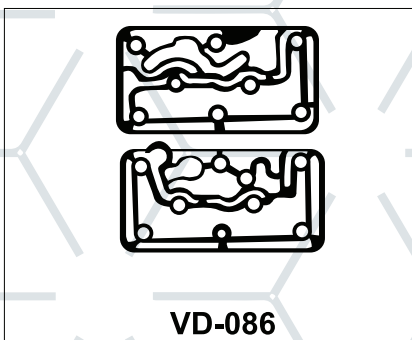

VD-086

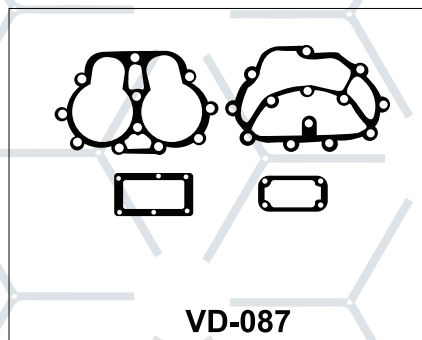

VD-087

**COMPRESORES**

ORIGINAL	FIRTS	APLICACIÓN
	VD-079	Juego de Juntas Compresor Electrónico N14
	VD-080	Juego de Juntas Compresor Wabco Doble Pistón para Volvo
	VD-081	Juego de Juntas Compresor York
	VD-082	Junta de Cabeza Compresor Brasileña
	VD-083	Junta de Compresor Wabco-Knorr
	VD-084	Juego de Juntas Compresor Mult-60 Cabeza Volada (412352005)
	VD-085	Juego de Juntas Compresor Wabco Doble Pistón Mercedes Benz
	VD-086	Juego de Juntas Compresor Cabeza Volada Volvo Wabco
	VD-087	Juego de Juntas Compresor Bendix Doble Pistón

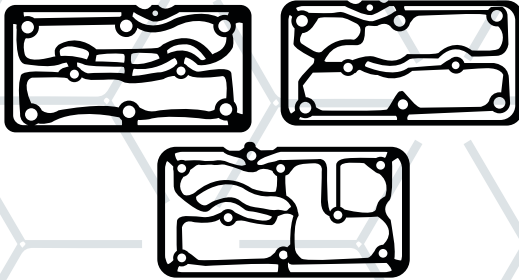

VD-088

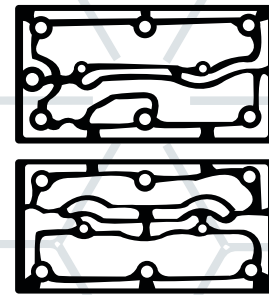

VD-089

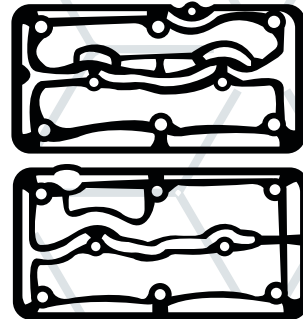

VD-090

ORIGINAL	FIRTS	APLICACIÓN
	VD-088	Juego de Juntas Compresor Wabco Doble Pistón Mercedes Benz
	VD-089	Juego de Juntas Compresor Wabco Doble Pistón Volvo
	VD-090	Juego de Juntas Compresor Wabco Doble Pistón Enfriado por Agua

<b>C-90230IM</b>	APLICACIÓN	AXOR Y ATEGO
	PUERTOS	
	MARCA	VADEN ORIGINAL

**CABEZA PARA COMPRESOR WABCO 904 MB 4 CILINDROS (411 161 803 2)**

<b>C-90231IM</b>	APLICACIÓN	MB, FOMEC, OTSRO 9 500R, 40-7 BUS
	PUERTOS	
	MARCA	VADEN ORIGINAL

**CABEZA PARA COMPRESOR WABCO 906 (412 352 801 2)**

<b>C-90232IM</b>	APLICACIÓN	AXOR Y ATEGO
	PUERTOS	
	MARCA	VADEN ORIGINAL

**CABEZA PARA COMPRESOR WABCO 904 REFORZADA (411 154 002 2)**

<b>C-90233IM</b>	APLICACIÓN	CUMMINS ISB/ISC /780/1250
	PUERTOS	M18 X 1.5
	MARCA	VADEN ORIGINAL

**CABEZA PARA COMPRESOR WABCO (911 153 921 2)**

<b>C-90234IM</b>	APLICACIÓN	CUMMINS ISB/ISC /500/4200
	PUERTOS	3/4" - 10 UNF
	MARCA	VADEN ORIGINAL

**CABEZA PARA COMPRESOR WABCO (911 153 920 2)**

<b>C-90235IM</b>	APLICACIÓN	CUMMINS ISB
	PUERTOS	
	MARCA	VADEN ORIGINAL

**CABEZA PARA COMPRESOR WABCO (911 154 920 2)**

<b>C-90236IM</b>	APLICACIÓN	VOLVO, MB, AXOR
	PUERTOS	
	MARCA	VADEN ORIGINAL

**CABEZA PARA COMPRESOR WABCO DOBLE PISTÓN (911 553 001 2)**

<b>C-90237IM</b>	APLICACIÓN	MB, AXOR, TRAVEGO
	PUERTOS	
	MARCA	VADEN ORIGINAL

**CABEZA PARA COMPRESOR WABCO CABEZA VOLADA (412 352 922 2)**

<b>C-90238IM</b>	APLICACIÓN	CUMMINS (L300) VM3600000
	PUERTOS	
	MARCA	VADEN ORIGINAL

**CABEZA PARA COMPRESOR**

<b>C-90239IM</b>	APLICACIÓN	DETROIT DIESEL SMO, CALIFORNIA 60
	PUERTOS	
	MARCA	VADEN ORIGINAL

**CABEZA PARA COMPRESOR BENDIX BA-921**



FT-0101039

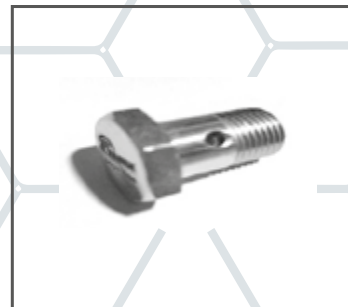

FT-0101038

ORIGINAL	FIRTS	APLICACIÓN
VA-0101039	FT-0101039	Tornillo P/904, 906 Reforma1 M17 * Pasa 1.5
VA-0101038	FT-0101038	Tornillo CAB Volada M16* Pasa * 1.5

**C-90151**

**REPUESTO PARA COMPRESOR KNORR 150**

**C-90151A**

**REPUESTO PARA COMPRESOR KNORR 150 CON JUNTA DE NEOPRENO (LK 1550, 1532, 1527, 1511)**

**C-90152**

**REPUESTO PARA COMPRESOR BENDIX 190**

**C-90153**

**REPUESTO PARA COMPRESOR KNORR 220, ENFRIADO POR AGUA**

**C-90154**

**REPUESTO PARA COMPRESOR KNORR 150/220 ENFRIADO POR AIRE**

**C-90156**

**REPUESTO PARA CABEZA DE COMPRESOR MIDLAND 2 3/4", MAYOR CON VALVULAS DE 1/2" Y 5/8", MAYOR**

**C-90158**

**REPUESTO PARA COMPRESOR WABCO 220, ENFRIADO POR AGUA**

**C-90159**

**REPUESTO PARA COMPRESOR WABCO 220, ENFRIADO POR AIRE**

**C-90161**

**REPUESTO PARA COMPRESOR KNORR LP3970, COMPLETO PARA VOLVO**

**C-90162**

**REPUESTO PARA COMPRESOR KNORR LP-4825 DOBLE PISTÓN, PARA VOLVO F10, F12, NL10 Y B10M**

**C-90163** MARCA VAGEN ORIGINAL

**REPUESTO PARA COMPRESOR KNORR LP-4974 DOBLE PISTÓN, PARA VOLVO B10, B12 FH12, FM7, SCANIA 4-5, HEAVY DUTY Y PERKINS**

**C-90164**

**REPUESTO PARA COMPRESOR KNORR LP-4985 DOBLE PISTÓN PARA VOLVO 20429343 FH, FH12, FH16, FM Y FM7**

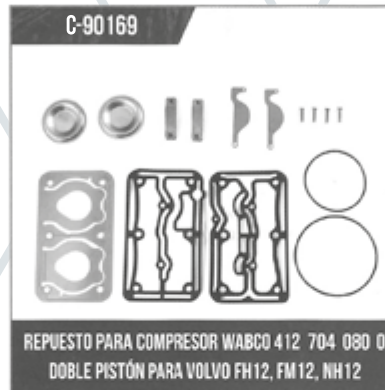
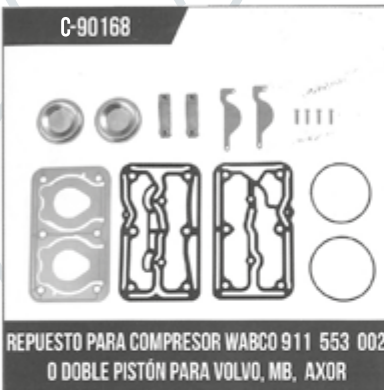
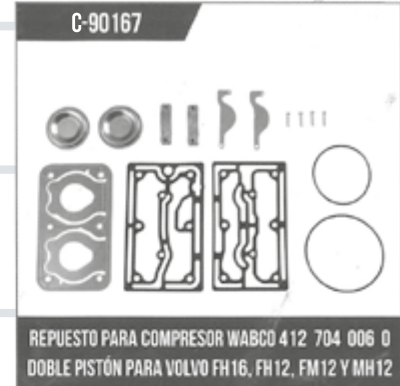
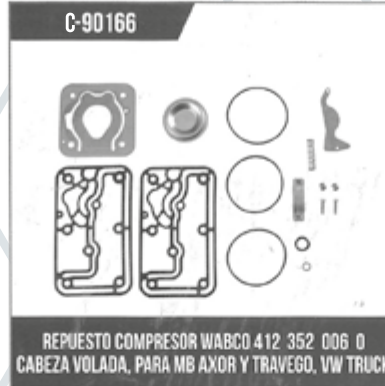

**C-90174** MARCA VAGEN ORIGINAL

REPUESTO PARA COMPRESOR WABCO 906 412 352 002 0 PARA EVO-BUS CITARO, 530N, MAYOR

**C-90176**

REPUESTO PARA COMPRESOR WABCO 911 153 000 0, PARA MB, AXOR, MAYOR

**C-90177**

REPUESTO PARA COMPRESOR WABCO 411 154 018 6 CON VALV. PARA MB 4CIL. AXOR, ATEGO, MAN, BASICO. JUNTA LIBRE DE ASBESTO

**C-90178**

REPUESTO PARA COMPRESOR WABCO 411 154 018 6 PARA MB 4CIL. AXOR, ATEGO, MAN, BÁSICO

**C-90179**

REPUESTO PARA COMPRESOR WABCO 911 153 654 6, MOTOR CUMMINS ISX, ISB, ISC. JUNTA LIBRE DE ASBESTO

**C-90180**

REPUESTO PARA COMPRESOR WABCO 911 159 654 6, MOTOR CUMMINS ISX, ISB, ISC

**C-90181**

REPUESTO PARA COMPRESOR WABCO 412 352 006 0, CABEZA VOLADA PARA MB, AXOR Y TRAVEGO VW TRUCK, BÁSICO

**C-90181A**

REPUESTO PARA COMPRESOR WABCO 412 352 006 0 CABEZA VOLADA PARA VOLVO FH12, FM12, NH12 Y FM9

**C-90181B**

REPUESTO PARA COMPRESOR WABCO 412 352 004 00 CABEZA VOLADA, PARA VOLVO 20478166

**C-90182**

REPUESTO PARA COMPRESOR WABCO 412 352 002 0 PARA MB 906, EVO BUS CITARO, JUNTA LIBRE DE ASBESTO

**C-90184**

REPUESTO PARA COMPRESOR WABCO 912 512 006 0 DOBLE PISTÓN, DOBLE VÁLVULA, PARA VOLVO B12M Y B12B

**C-90185**

REPUESTO PARA COMPRESOR WABCO 911 155 514 0 PARA CUMMINS 03972531, V. WORKER

**C-90186**



**REPUESTO PARA COMPRESOR WABCO 411 154 004 O, PARA MB AXOR Y ATEGO**

**C-90187**



**REPUESTO PARA COMPRESOR KNORR LK-3833, PARA VW BUS, VOLVO FL6 Y CUMMINS 3285089, MAYOR**

**C-90188**



**REPUESTO PARA COMPRESOR KNORR LK-3833, PARA VW BUS, VOLVO FL6 Y CUMMINS 3285089, BASICO**

**C-90190**



**REPUESTO PARA COMPRESOR BENDIX BA-921 PARA MOTOR DETROIT DIESEL S60 DD5 CATERPILLAR**

**C-90192**



**REPUESTO PARA COMPRESOR KNORR LK3863 PARA WORKER, MAYOR**

**C-90193**



**REPUESTO PARA COMPRESOR KNORR LK 3863 PARA WORKER, BÁSICO**

**C-90194**



**REPUESTO PARA COMPRESOR MB S-400 DOBLE VÁLVULA ESCAPE, OM-401 Y OM-402**

**C-90195**



**REPUESTO PARA COMPRESOR KNORR DOBLE VÁLVULA DE ESCAPE PARA VW BUS, MAYOR**

**C-90196**



**REPUESTO PARA COMPRESOR KNORR DOBLE VÁLVULA DE ESCAPE, PARA VW BUS, BASICO**

**C-90197**



**REPUESTO PARA COMPRESOR BENDIX BA-921 PARA MB, OM 472 DETROIT S60/CATERPILLAR**

**C-90201**



**REPUESTO PARA COMPRESOR BENDIX BX-2150**

**C-90202**



**REPUESTO PARA COMPRESOR CUMMINS 335/350, MAYOR**

# REPUESTOS PARA COMPRESORES



**C-90203**

**REPUESTO PARA COMPRESOR CUMMINS 335/350, MENOR**

**C-90204**

**REPUESTO PARA COMPRESOR MIDLAND 2"**

**C-90205**

**REPUESTO PARA COMPRESOR TU-FLO 400**

**C-90206**

**REPUESTO PARA COMPRESOR TU-FLO 500**

**C-90207**

**REPUESTO PARA COMPRESOR TU-FLO 501**

**C-90208**

**REPUESTO PARA COMPRESOR TU-FLO 550/750**

**C-90209**

**REPUESTO PARA COMPRESOR TU-FLO 550/750, BASICO**

**C-90210**

**REPUESTO PARA COMPRESOR HOLSET ELECTRÓNICO TAPA CIEGA N-14**

**C-90211**

**REPUESTO PARA COMPRESOR HOLSET MECÁNICO SERIE "C" CON 4 JUNTAS**

**C-90212**

**REPUESTO PARA COMPRESOR CUMMINS 335/350 CON 7 JUNTAS**

**C-90213**

**TAPA DE COMPRESOR DE AIRE CUMMINS 155-350**

**C-90214**

**REPUESTO PARA COMPRESOR WABCO 412 036 001 0 DOBLE PISTÓN, PARA EVOBUS CITARO ARTICULATED BUS**

C-90215

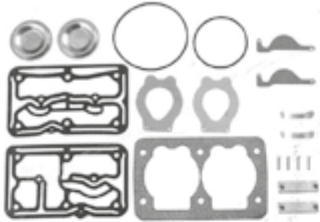

REPUESTO PARA COMPRESOR WABCO 412 636 001  
O PARA MB EVOBUS CITARO ARTICULATED BUS

C-90216

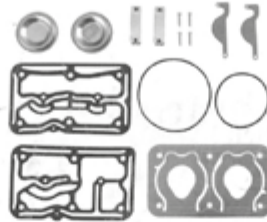

REPUESTO PARA COMPRESOR WABCO 412 636 001 O  
PARA EVOBUS CITARO MB ARTICULATED BUS

C-90216B

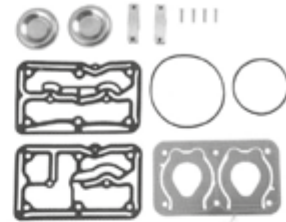

REPUESTO PARA COMPRESOR WABCO 412 636 001  
O, PARA EVOBUS CITARO MB ARTICULATED BUS SIN  
CABALLOS

C-90217

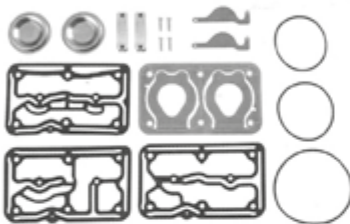

REPUESTO PARA COMPRESOR WABCO 911 553 002  
O PARA AXOR EVOBUS CITARO MB  
ARTICULATED BUS

C-90219

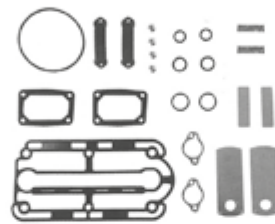

REPUESTO PARA COMPRESOR KNORR  
BREMSE SCANIA L-94, 4 SERIES F-K-N BUS

C-90220

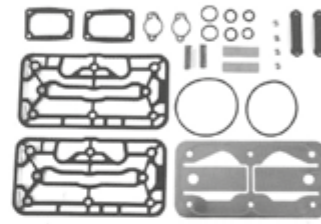

REPUESTO PARA COMPRESOR KNORR BREMSE  
LK-4930 PARA SCANIA N-94 4 SERIES BUS

C-90221

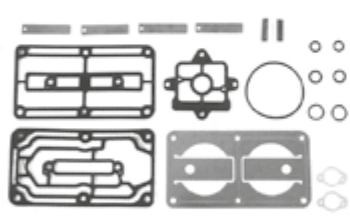

REPUESTO PARA COMPRESOR KNORR BREMSE  
LK-4948, PARA SCANIA 4 SERIES TRUCK EUROS

C-90222

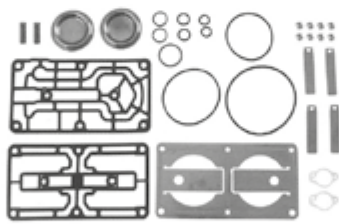

REPUESTO PARA COMPRESOR KNORR BREMSE  
LK4949, 4956, 4951, PARA SCANIA N-94, 4 SERIES  
BUS, FKN-BUS.

C-90223

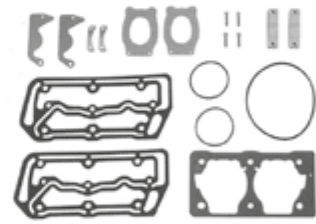

REPUESTO PARA COMPRESOR KNORR BREMSE 911  
516 500 O, PARA CUMMINS ISB. (USB DOBLE)

C-90224

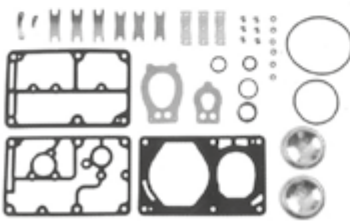

REPUESTO PARA COMPRESOR VOITH  
LP-490, PARA MB

C-90225

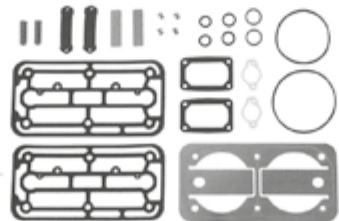

REPUESTO PARA COMPRESOR BENDIX 50 136389  
PARA JOHN DEERE, CATERPILLAR

C-90916



TAPA CARTER PARA COMPRESOR 904



## FLECHAS LATERALES



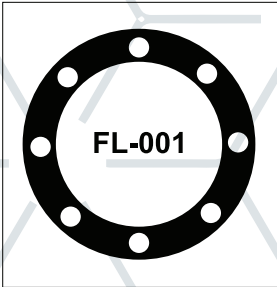

**DF-337082**  
**JUNTA FLECHA LATERAL**  
 8 Birlos, Camión Dina  
 Series 500-531 No. Original  
 89218-09 Opcional con  
 Agujeros de 1/2", 9/16", 5/8"

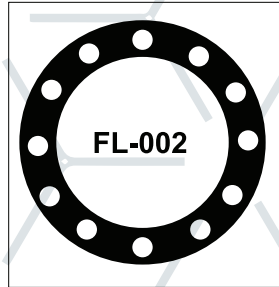

**DF-337056**  
**JUNTA FLECHA LATERAL**  
 12 Birlos, Camión Dina Series  
 600-631 No. Original 222218-09  
 Ford Camión F8 F-800 1948-64  
 Eje Eaton 63/16" 1790 18802  
 Dodge D-600, 1995-91 GMC  
 Serie 450, 1951-54 Opcional con  
 Agujeros de 1/2", 9/16", 5/8"

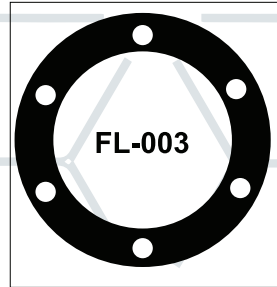

**JUNTA FLECHA LATERAL**  
 Camiones  
 Delfin Panorámico

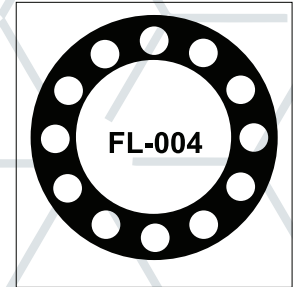

**JUNTA FLECHA LATERAL**  
 Camiones  
 GMC-Convencional

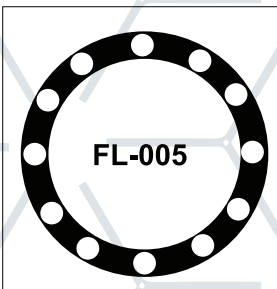

**JUNTA FLECHA LATERAL**  
 Camión Ford  
 Camión Dodge  
 Agujeros 9/16"

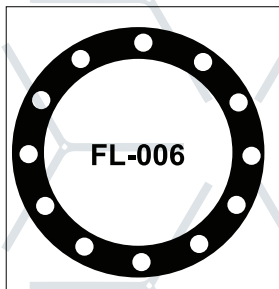

**JUNTA FLECHA LATERAL**  
 Camión Ford  
 Camión Dodge  
 Agujeros 5/8"

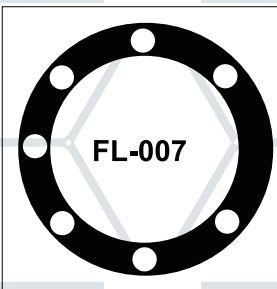

**JUNTA FLECHA LATERAL**  
 Chrysler  
 Microbús

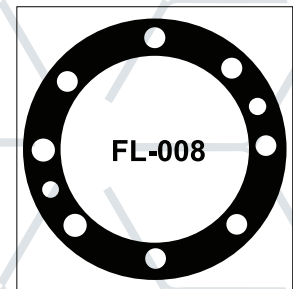

**JUNTA FLECHA LATERAL**  
 Autobús Delfin Panorámico  
 No. Original 38218-09

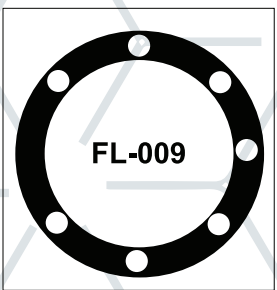

**DF-337036-A**  
**JUNTA FLECHA LATERAL**  
 Camión Ford F-300, F-600  
 Camión Dodge F-G-H-J-M  
 400-500  
 Camión Ligero 1.5 Tons

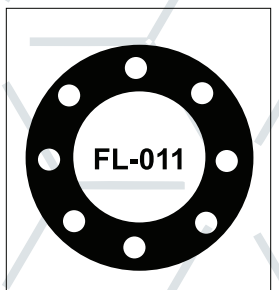

**JUNTA FLECHA LATERAL**  
 Camión Internacional

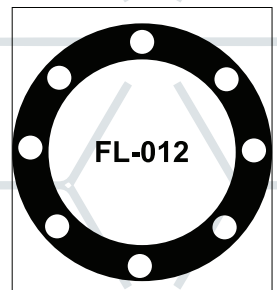

**JUNTA FLECHA LATERAL**  
 Autobús Masa, Somex con  
 Agujeros de 3/4"

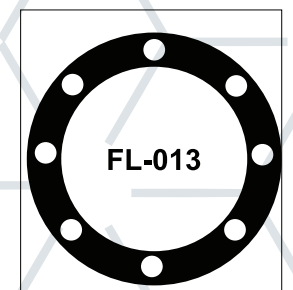

**JUNTA FLECHA LATERAL**  
 Autobús Dina No. Original  
 2208-W-413 con  
 Agujeros de 5/8"

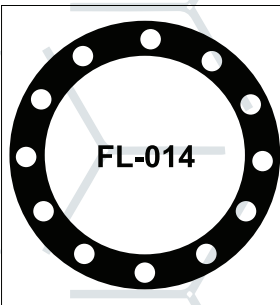

**FL-014**  
JUNTA FLECHA LATERAL  
Tractocamión Kenworth  
12 Agujeros de 1/2"

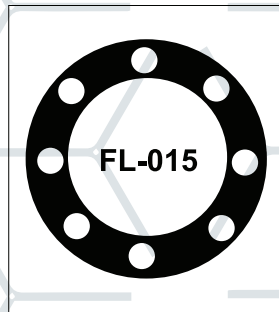

**FL-015**  
DF-337040  
JUNTA FLECHA LATERAL  
Ford Camión D-300 1965-91  
F-350, 400 1973-91 Dodge  
Camión D-350 1965-91 Eje  
Spicer 70 Microbús Chasis  
3.5 Tons.

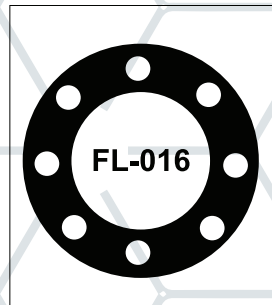

**FL-016**  
DF-337014-A  
JUNTA FLECHA LATERAL  
Chevrolet Camión C-350 1  
Tons. 1957-84 GMC, Serie  
100,150,250 1939-56, Eje  
Spicer Mod. 70, Microbús  
Chasis 3.5 Tons. Chevrolet



**FL-017**  
DF-337009  
JUNTA FLECHA LATERAL  
Chevelle-Nova-Datsun  
Sedán, Pick-up  
Volkswagen Sedán  
1200-1500-1600, C.C. 1965-91  
Opel, Todos

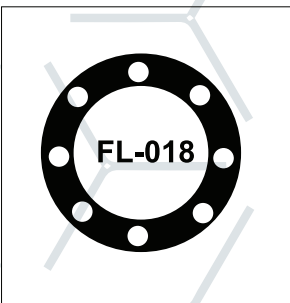

**FL-018**  
DF-337012  
JUNTA FLECHA LATERAL  
Chevrolet C-1500,35-34  
1 1/2 Tons.  
No. Original 3653928  
Dodge Ford  
Microbús

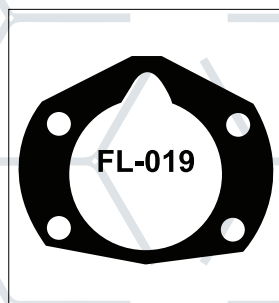

**FL-019**  
DF-337055  
JUNTA FLECHA LATERAL  
Ford Sedán, Fairlane,  
Galaxie, Ford 200, Mustang  
8, Rambler, Mercury Spicer  
44,30 Todos

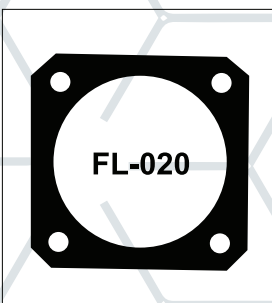

**FL-020**  
DF-337010  
JUNTA FLECHA LATERAL  
Chevrolet, Impaña, Caprice,  
Camión C10 1967-82  
Willys-Jeep CJ-5, J164,  
J-262 1965-86  
Eje Spicer 44

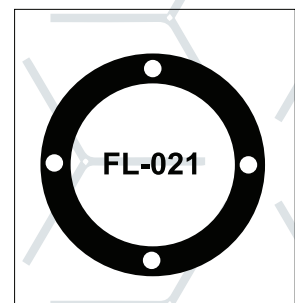

**FL-021**  
TAPA DE MAZA  
Rueda Delantera Dina  
Serie 500-600

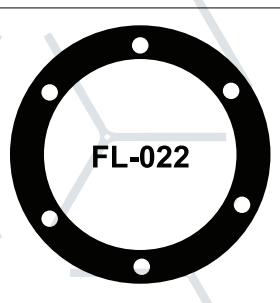

**FL-022**  
TAPA DE MAZA  
Rueda Delantera Dina y  
Camión Somex

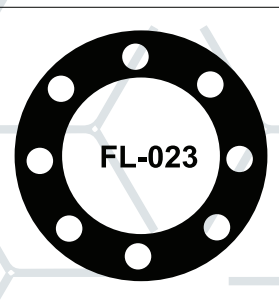

**FL-023**  
JUNTA FLECHA LATERAL  
Chrysler  
Microbús

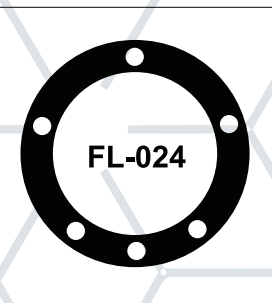

**FL-024**  
JUNTA FLECHA LATERAL  
Eje Sudisa

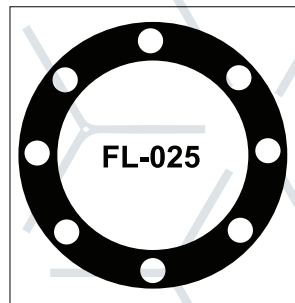

**FL-025**  
JUNTA FLECHA LATERAL  
Camión Navistar

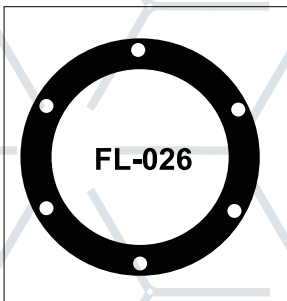

**JUNTA TAPA DE MAZA**  
Camiones Dina Series  
600-631

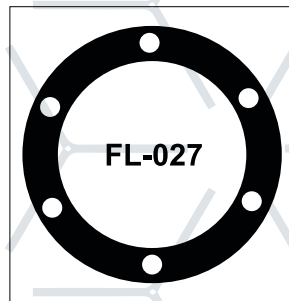

**JUNTA FLECHA LATERAL**  
Eje Loco

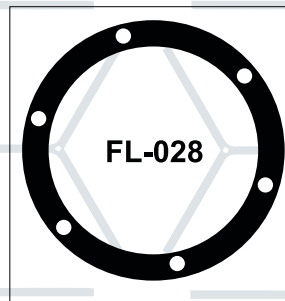

**JUNTA FLECHA LATERAL**  
Camiones Motor Navistar

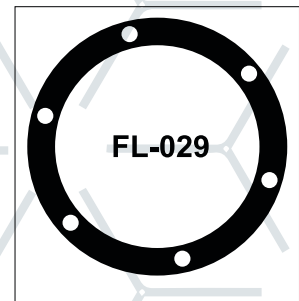

**JUNTA FLECHA LATERAL**  
Dina - Famsa

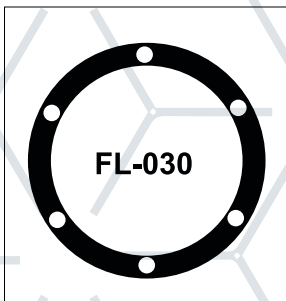

**JUNTA FLECHA LATERAL**  
Eje Sudisa

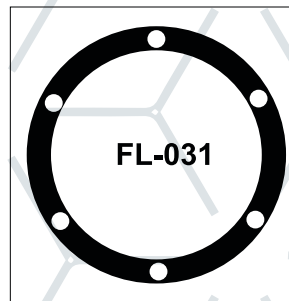

**JUNTA FLECHA LATERAL**  
Eje Loco Americano

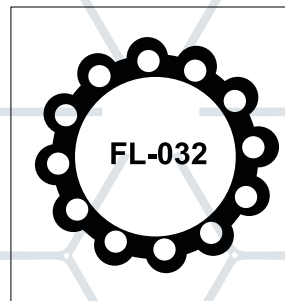

**JUNTA FLECHA VOCHOBUS**

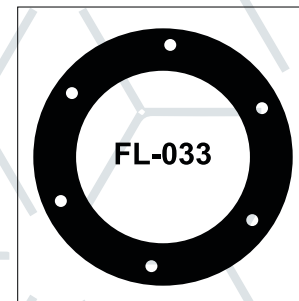

**JUNTA DE FLECHA**  
6 BARRENOS

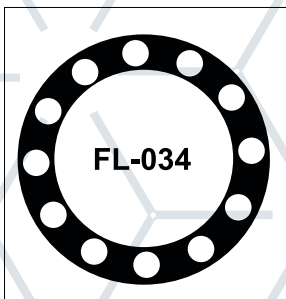

**JUNTA FLECHA**  
12 BARRENOS

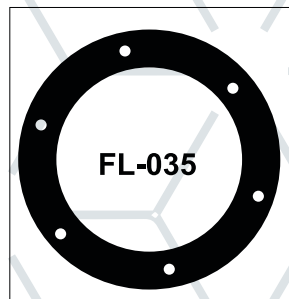

**JUNTA FLECHA**  
6 BARRENOS

FLECHAS LATERALES



# EMPAQUES AUTOMOTRICES FIRTS

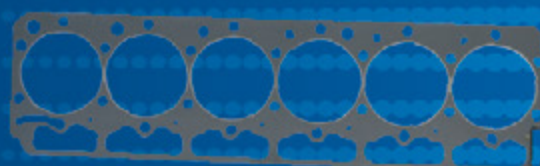
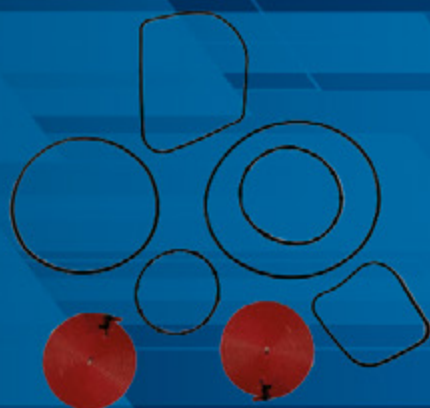

## CONTÁCTANOS

[ventas.firts@gmail.com](mailto:ventas.firts@gmail.com)  
[contacto@firtsdiesel.com](mailto:contacto@firtsdiesel.com)

☎ 01 779 796 3721

☎ 01 779 796 7333

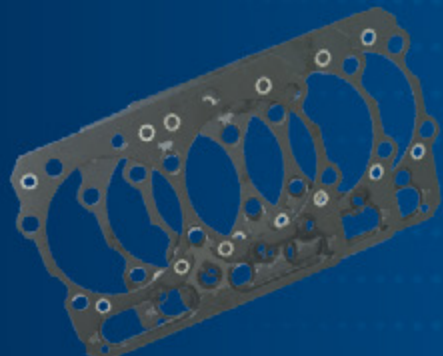

[www.firtsdiesel.com](http://www.firtsdiesel.com)