

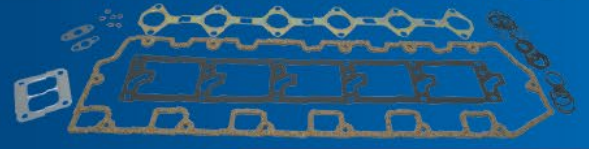

CATÁLOGO DIESEL

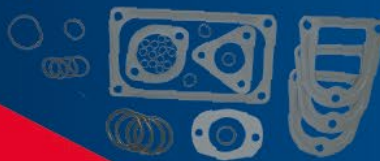

**EMPAQUES Y JUNTAS
PARA PROFESIONALES**

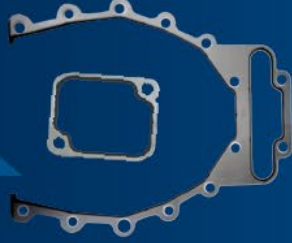
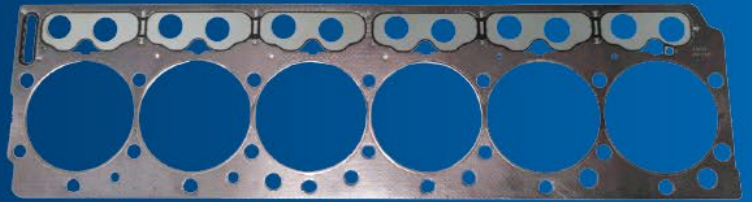
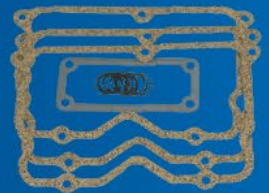



AGRADECIMIENTOS

FIRTS DIESEL GASKETS es una empresa que mantiene altos estándares de calidad y servicio, gracias al apoyo de todos nuestros colaboradores que con su esfuerzo y empeño diario durante estos 15 años, han demostrado dedicación en fabricar los mejores productos y brindar el mejor servicio del mercado.

Asimismo, agradecemos a nuestros proveedores que son socios estratégicos en el funcionamiento de nuestra empresa, cumpliendo con tiempos de entrega y calidad en los materiales.

Finalmente, el éxito alcanzado se lo debemos a ustedes estimados clientes por depositar su confianza en nosotros, gracias por su preferencia durante esta gran trayectoria.



CUMMINS ISX

3100895	FT-ISX-15	Goma Aisladora Tapa ISX (Solo Goma)
3685535	FES-ISX-T15	Junta Turbo CUMMINS ISX 15
4973532	FISX-15-2	Junta Enfriador de Aceite CUMMINS ISX

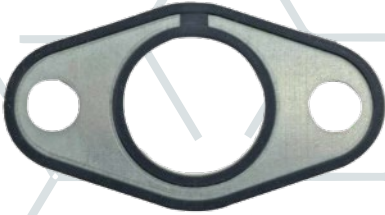

FISX-15-2



FT-ISX-15



FES-ISX-T15

4973532

FISX-15-2

3100895

FT-ISX-15

3685535

FES-ISX-T15

Junta Enfriador de Aceite CUMMINS ISX

Goma Aisladora Tapa ISX (Solo Goma)

Junta Turbo CUMMINS ISX 15

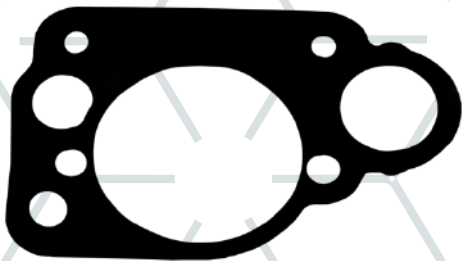

FISX-13



FISX-15-1

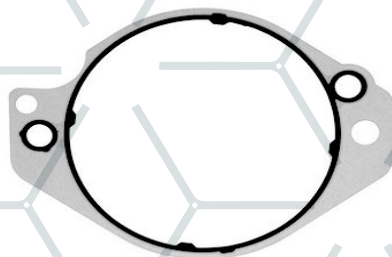

FISX-12

4026684

FISX-13

Junta soporte bomba combustible ISX

3386758

FISX-15-1

Junta Bomba de combustible ISX 15

3685614

FISX-12

Junta Montage de compresor



DETROIT

23512307

**F60-13
F60-SUC**

**Goma Aisladora Montaje S-60
Juego de Juntas succión DETROIT S-60**



F60-13



F60-SUC

23512307

**F60-13
F60-SUC**

**Goma Aisladora Montaje S-60
Juego de Juntas succión DETROIT S-60**



NAVISTAR[®]

NAVISTAR NDG

F214-31

Juego compresor NAVISTAR 466

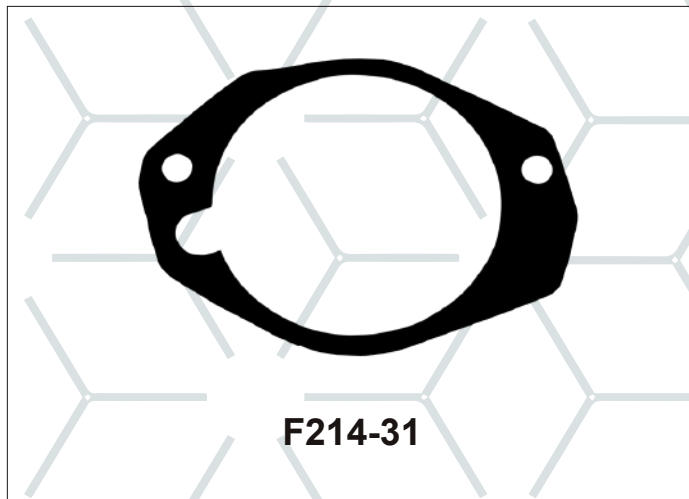

F214-31

Juego compresor NAVISTAR 466



PACCAR

PACCAR

FMJ-PAC-1MX13	JGO JUNTAS SUPERIOR PACCAR MX13
FCA-PAC-MX13	JTA CABEZA PACCAR MX13
FPS-PAC-MX13	JTA TAPA PUNTERIA PACCAR MX13
FMU-PAC-EMX13	JTA MULTIPLE ESCAPE PACCAR MX13 (EMPAQ. 6 PZ)

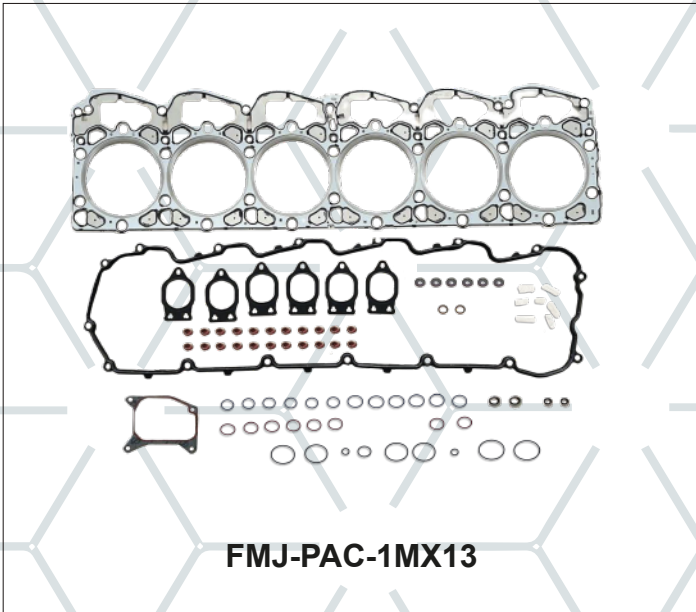

FMJ-PAC-1MX13

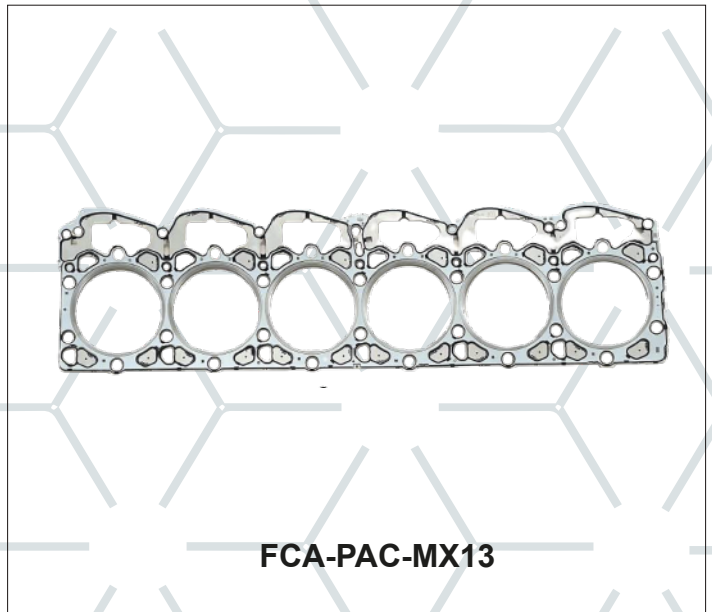

FCA-PAC-MX13

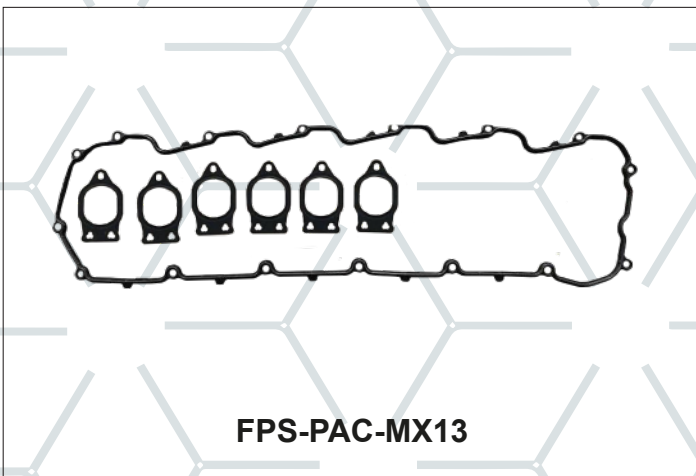

FPS-PAC-MX13

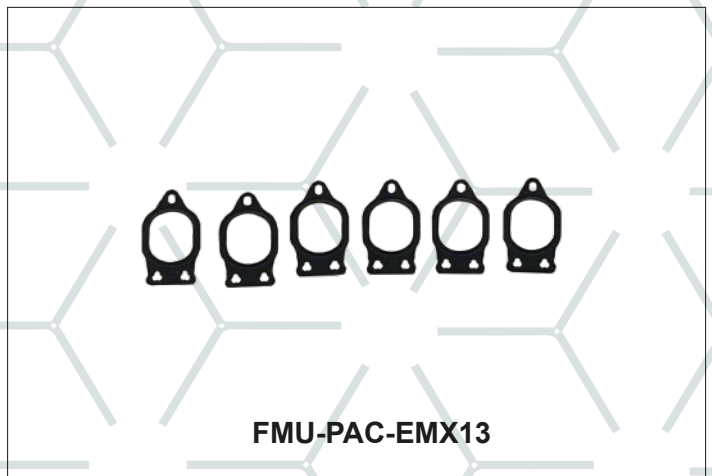

FMU-PAC-EMX13

ORIGINAL	FIRTS	APLICACIÓN
2140884	FMJ-PAC-1MX13	JGO JUNTAS SUPERIOR PACCAR MX13
1874963	FCA-PAC-MX13	JTA CABEZA PACCAR MX13
1924761	FPS-PAC-MX13	JTA TAPA PUNTERIA PACCAR MX13
1926047	FMU-PAC-EMX13	JTA MULTIPLE ESCAPE PACCAR MX13 (EMPAQ. 6 PZ)



COMPRESORES

306010047

FC-306010047

Cilindro esclavo Kenworth Volvo Freightline

0101177

FC-177

Base filtro separador de agua MB y FORD



compresor FC-306010047



FC-177

**306010047
0101177**

**FC-306010047
FC-177**

**Cilindro esclavo Kenworth Volvo Freightline
Base filtro separador de agua MB y FORD**

EMPAQUES AUTOMOTRICES FIRTS

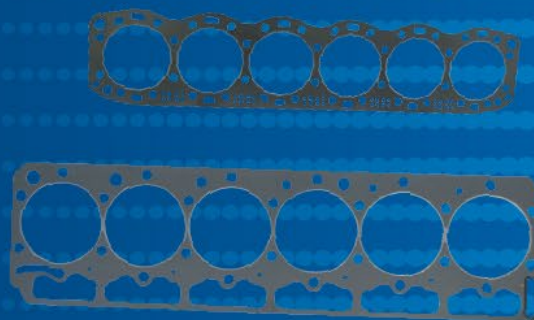
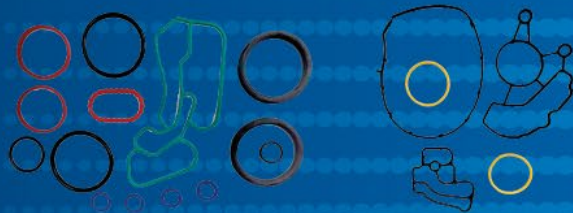
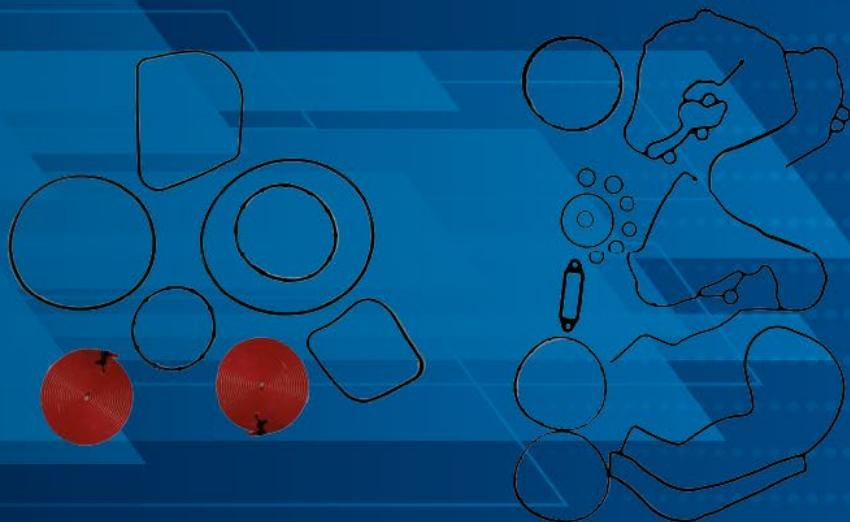

CONTÁCTANOS

ventas.firts@gmail.com
contacto@firtsdiesel.com

☎ 01 779 796 3721

☎ 01 779 796 7333

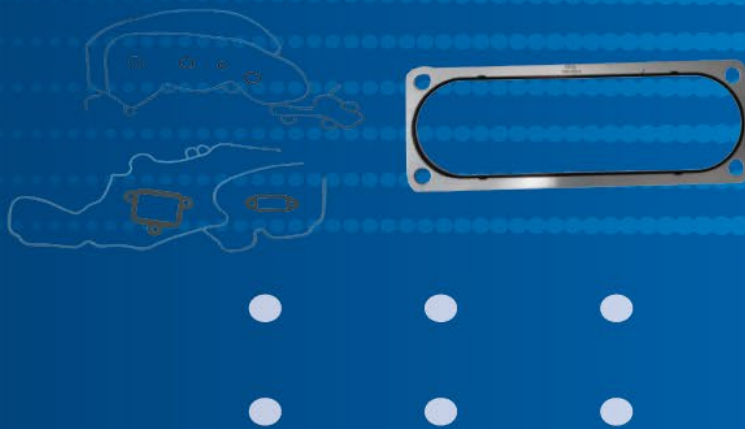
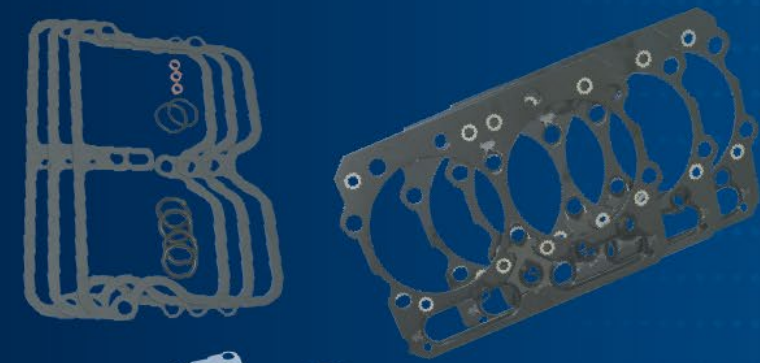

www.firtsdiesel.com